

LAMPA 

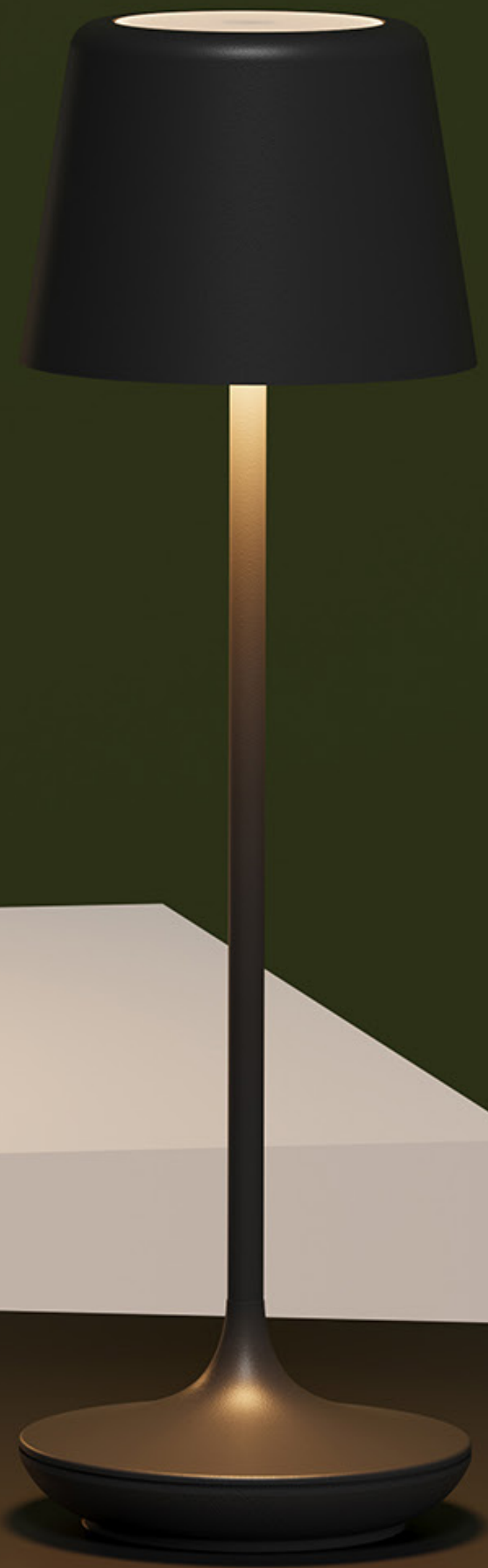

Introducing Lampa

Designed & developed in Europe, manufactured in China, Lampa rechargeable lamps answer the growing need for hybrid hosting in the HoReCa channel. We are now in the position to offer a variety of high-quality long-lasting rechargeable light fixtures, **to all market segments. Rechargeable cordless LED lamps for indoor / outdoor use,** add a nomadic ability to table positioning and hosting.



Andrew 240

F2200S-240Z-RC

LED, 2200K/2700K, 2.5W, DC3.7V, with RC function, without adapter

Available in the following colors:

BLACK & GOLD



Specifications

Serial No.	F2200S-240Z-RC
Material	Die-casting aluminium alloy
Safety Class	CLASS III
Ingress Protection	IP65
Dimension	Φ60*200mm
Inner box / master carton	11×9×30cm / 38×35×32cm
Net Weight	770g
Light Source	OSRAM SMD 2835
CRI	≥ 80
Power	2.3W
Input Voltage	DC 3.7V
Luminaire Flux	252lm
Switch	Touch ON/OFF, Remote Control
Color Temp.	2200K / 2700K (switchable)
Dimmer	Stepless dimmable 5%-100%
Memory Function	Memory of brightness, color temp.
Battery Type	Li-ion battery
Battery Capacity	3000mA
Battery charging time	≤ 3 hours
Battery working time	≥ 8 hours(100% light intensity)
Adapter (optional)	CLASS II; Input AC100-240V; Output DC 5V1A

NEW COLLECTION

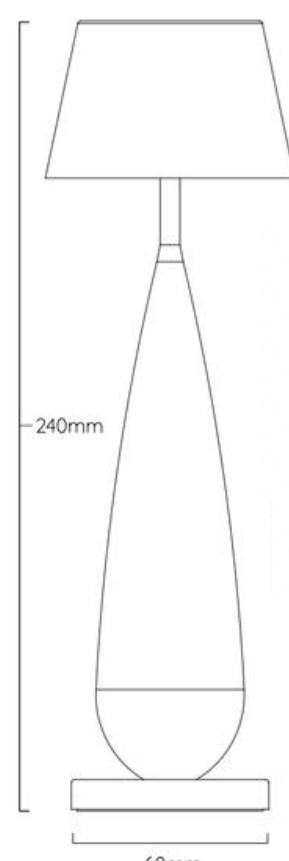
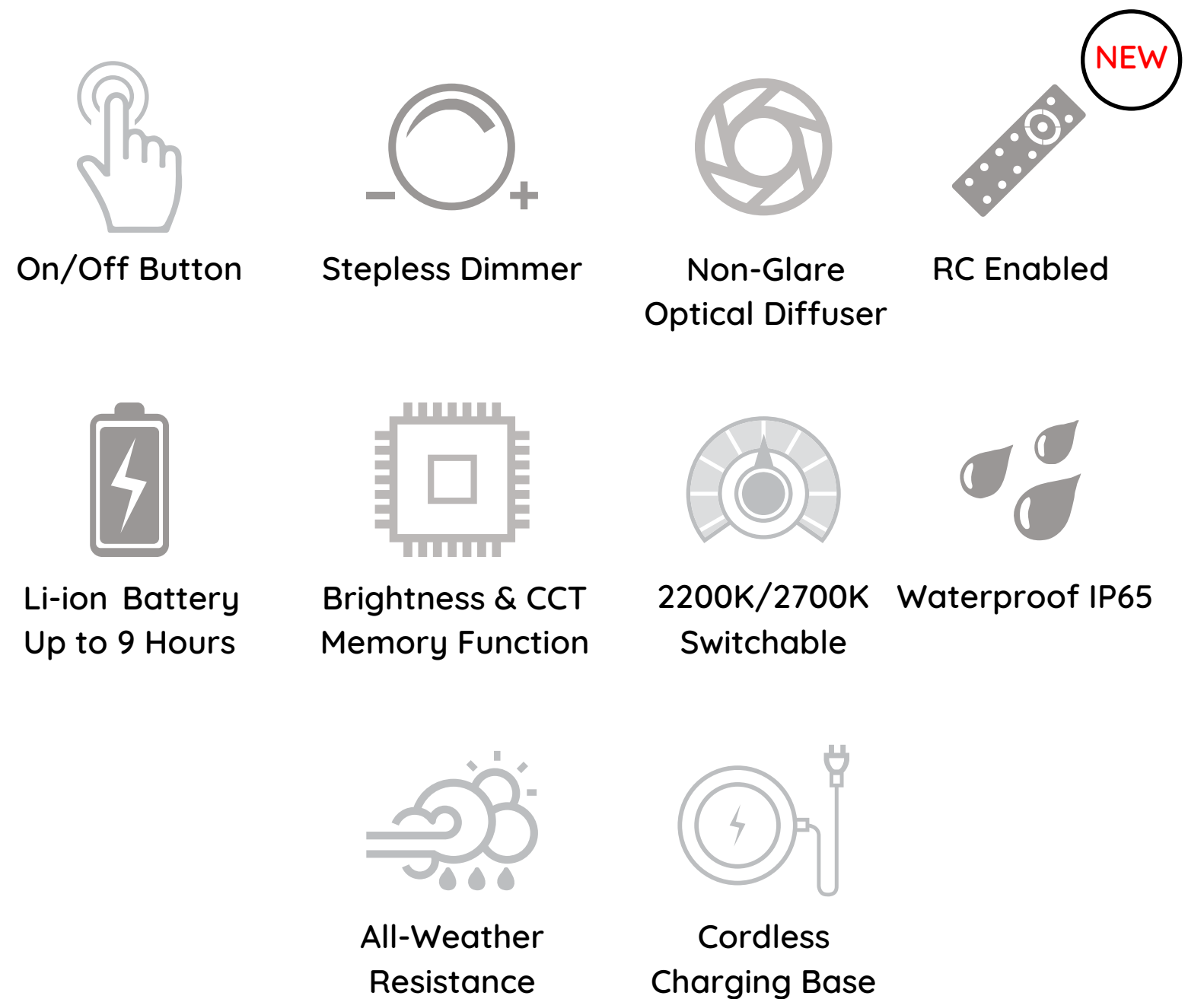

GRACE 200

F2082-200-RC

LED, 2200K/2700K, 2.5W, DC3.7V, with RC function, without adapter

Available in the following colors:



Specifications

Serial No.	F2082-200-RC
Material	Die-casting aluminium alloy
Safety Class	CLASS III
Ingress Protection	IP65
Dimension	Φ60*200mm
Inner box / master carton	9.5×8.5×25.5cm / 27.5*21*28cm
Net Weight	387g
Light Source	OSRAM SMD 2835
CRI	≥ 80
Power	2.3W
Input Voltage	DC 3.7V
Luminaire Flux	252lm
Switch	Touch ON/OFF, Remote Control
Color Temp.	2200K / 2700K (switchable)
Dimmer	Stepless dimmable 5%-100%
Memory Function	Memory of brightness, color temp.
Battery Type	Li-ion battery
Battery Capacity	3000mA
Battery charging time	≤ 4.5 hours
Battery working time	≥ 9 hours(100% light intensity)
Adapter (optional)	CLASS II; Input AC100-240V; Output DC 5V1A

NEW COLLECTION

- On/Off Button
- Stepless Dimmer
- Non-Glare Optical Diffuser
- RC Enabled NEW
- Li-ion Battery Up to 9 Hours
- Brightness & CCT Memory Function
- 2700K/3000K Switchable
- Waterproof IP65
- All-Weather Resistance
- Cordless Charging Base

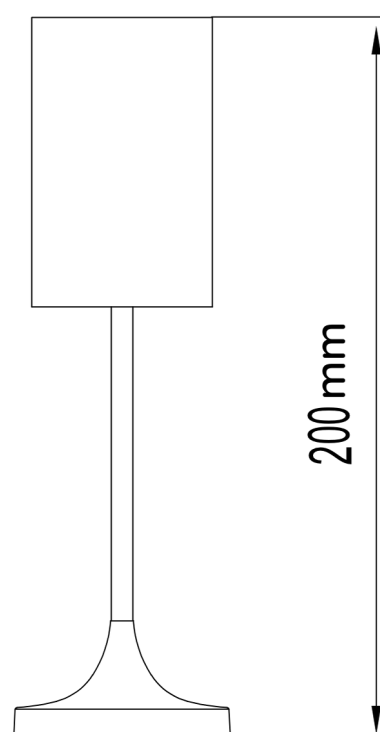

Luna 300 F2010-300P-RC

LED, 2200K/2700K, 2.7W, DC3.7V, with RC function, without adaptor

Available in the following colors:

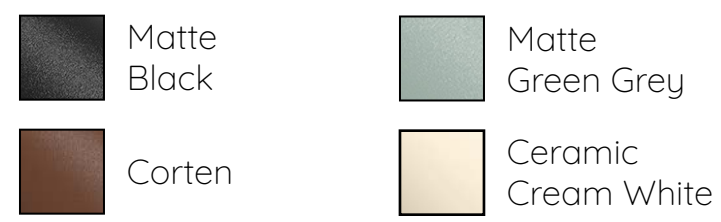

Specifications

Serial No.	F2010-300P-RC
Material	Die-casting aluminium alloy
Safety Class	CLASS III
Ingress Protection	IP65
Dimension	Φ112*300mm
Inner box / master carton	15×12.5×34.5cm / 39.5×32×36.5 cm
Net Weight	1000g
Light Source	OSRAM SMD 2835
CRI	≥ 80
Power	2.2W
Input Voltage	DC 3.7V
Luminaire Flux	201lm
Switch	Touch ON/OFF, Remote Control
Color Temp.	2200K / 2700K (switchable)
Dimmer	Stepless dimmable 5%-100%
Memory Function	Memory of brightness, color temp.
Battery Type	Li-ion battery
Battery Capacity	3000mA
Adaptor (optional)	CLASS II; Input AC100-240V; Output DC 5V1A

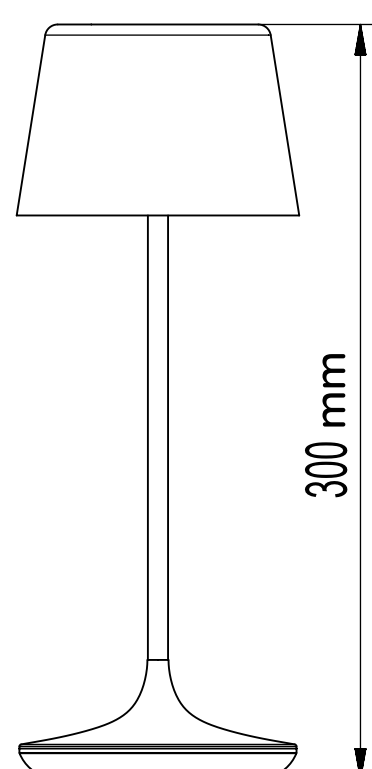
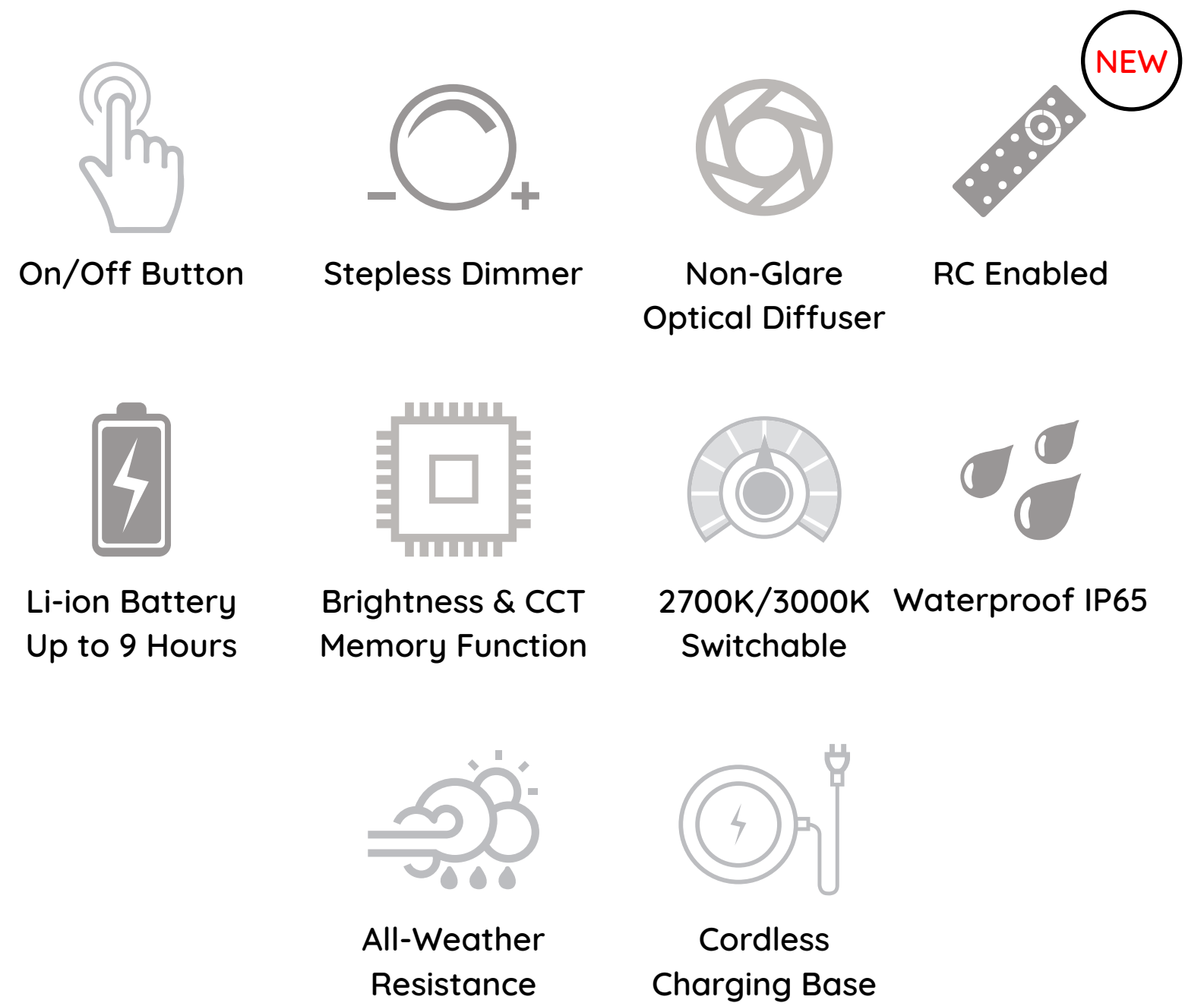

Luna Micro F2010S-250P-RC

LED, 2200K/2700K, 2.5W, DC3.7V, With RC function, without adaptor

Available in the following colors:



Specifications

Serial No.	F2010S-250P-RC
Material	Die-casting aluminium alloy
Safety Class	CLASS III
Ingress Protection	IP65
Dimension	Φ75*250mm
Inner box / master carton	11×9×30cm / 24×29×32cm
Net Weight	486g
Light Source	OSRAM SMD 2835
CRI	≥ 80
Power	2.5W
Input Voltage	DC 3.7V
Luminaire Flux	205lm
Switch	Touch ON/OFF, Remote Control
Color Temp.	2200K / 2700K (switchable)
Dimmer	Stepless dimmable 5%-100%
Memory Function	Memory of brightness, color temp.
Battery Type	Li-ion battery
Battery Capacity	3000mA
Adaptor (optional)	CLASS II; Input AC100-240V; Output DC 5V1A

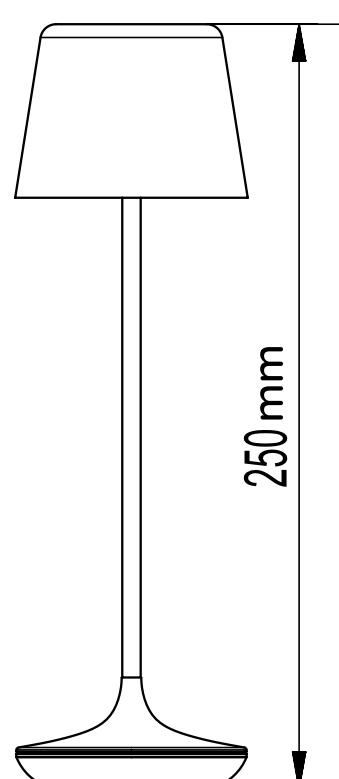
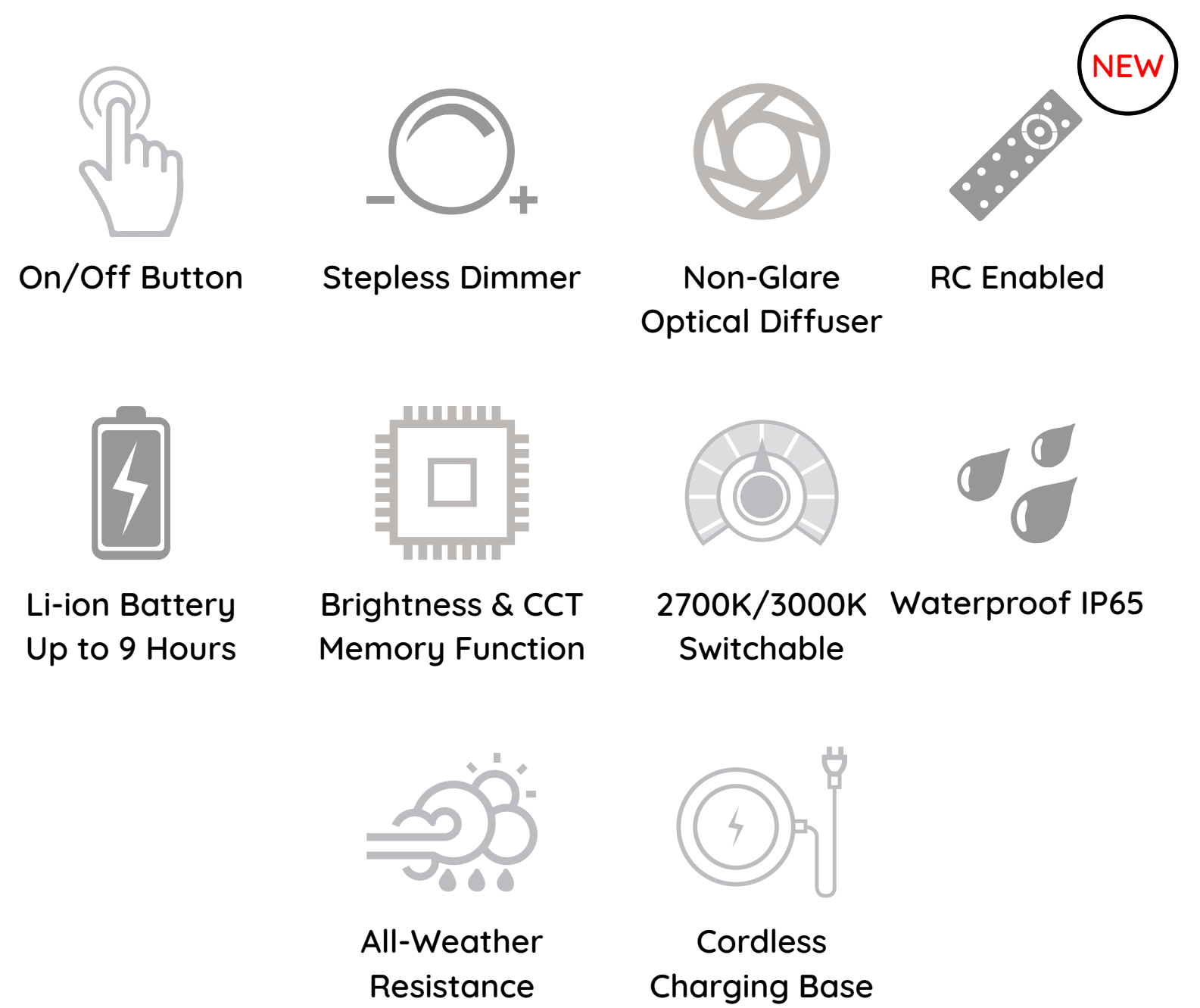

Vina 200

F2080-200-RC

LED, 2200K/2700K, 2.5W, DC3.7V, with RC function, without adapter

Available in the following colors:



Specifications

Serial No.	F2080-200-RC
Material	Die-casting aluminium alloy
Safety Class	CLASS III
Ingress Protection	IP65
Dimension	Φ60*200mm
Inner box / master carton	9.5*8.5*25.5cm / 27.5*21*28cm
Net Weight	387g
Light Source	OSRAM SMD 2835
CRI	≥ 80
Power	2.3W
Input Voltage	DC 3.7V
Luminaire Flux	252lm
Switch	Touch ON/OFF, Remote Control
Color Temp.	2200K / 2700K (switchable)
Dimmer	Stepless dimmable 5%-100%
Memory Function	Memory of brightness, color temp.
Battery Type	Li-ion battery
Battery Capacity	3000mA
Battery charging time	≤ 4.5 hours
Battery working time	≥ 9 hours(100% light intensity)
Adapter (optional)	CLASS II; Input AC100-240V; Output DC 5V1A

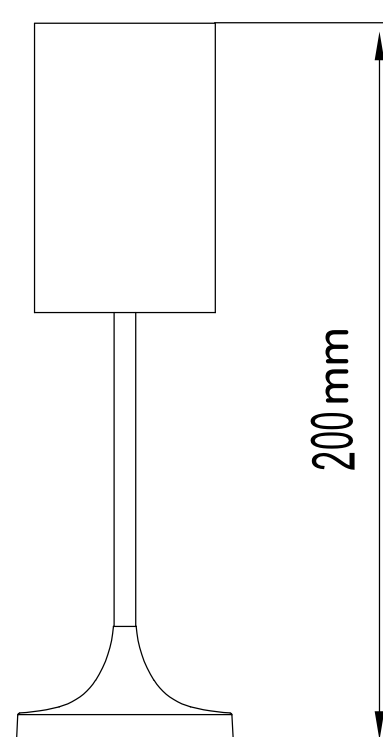
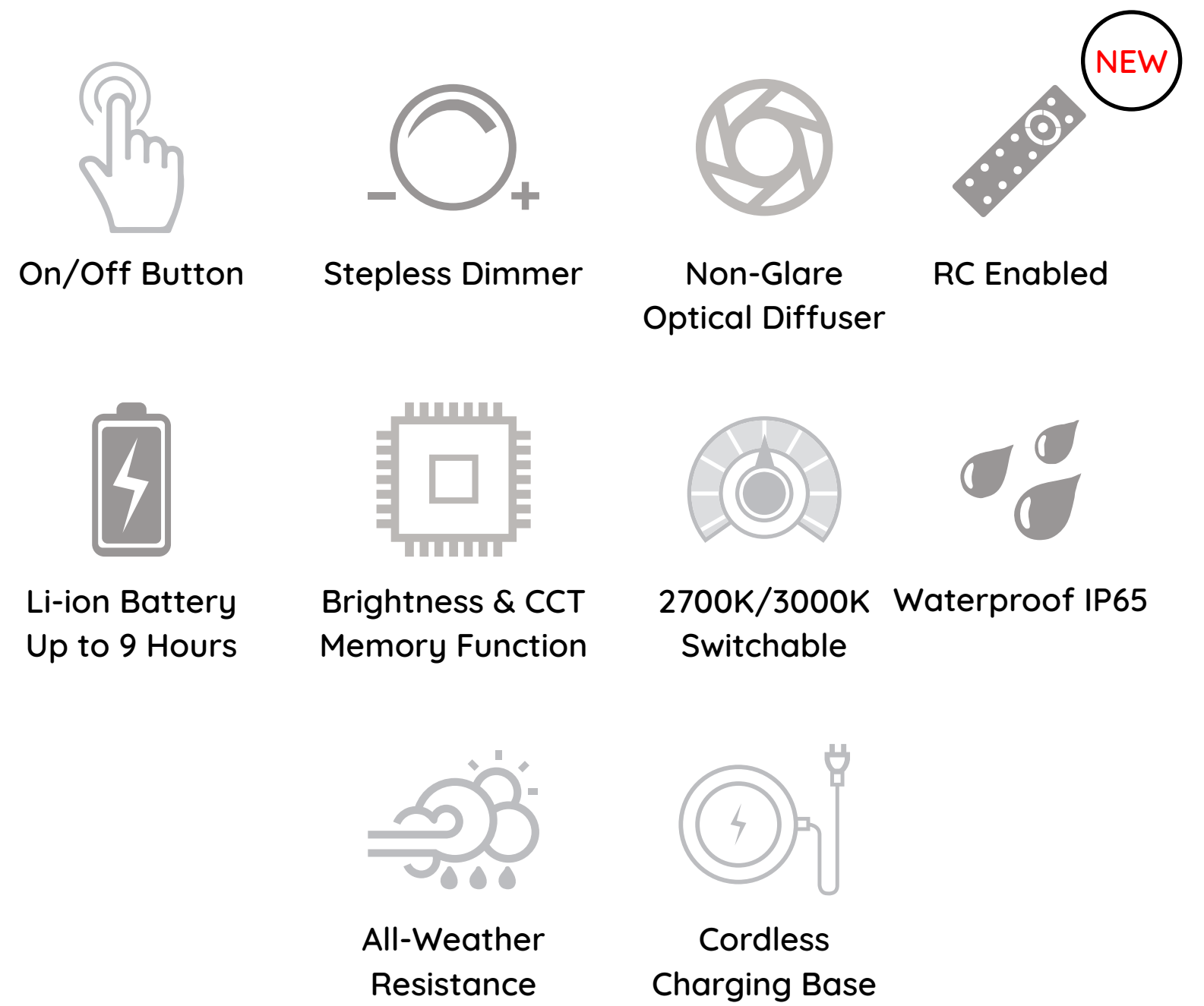

Vino 200

F2081-200-RC

SMD, 2200K/2700K, 2.3W, DC3.7V, with RC function, without adapter

Available in the following colors:

 Ceramic
 Pearl White



Specifications

Serial No.	F2081-200-RC
Material	Die-casting aluminium alloy
Safety Class	CLASS III
Ingress Protection	IP65
Dimension	Φ60*200mm
Inner box / master carton	9.5*8.5*25.5cm / 27.5*21*28cm
Net Weight	387g
Light Source	OSRAM SMD 2835
CRI	≥ 80
Power	2.3W
Input Voltage	DC 3.7V
Luminaire Flux	248lm
Switch	Touch ON/OFF, Remote Control
Color Temp.	2200K / 2700K (switchable)
Dimmer	Stepless dimmable 5%-100%
Memory Function	Memory of brightness, color temp.
Battery Type	Li-ion battery
Battery Capacity	3000mA
Battery charging time	≤ 4.5 hours
Battery working time	≥ 9 hours(100% light intensity)
Adapter (optional)	CLASS II; Input AC100-240V; Output DC 5V1A

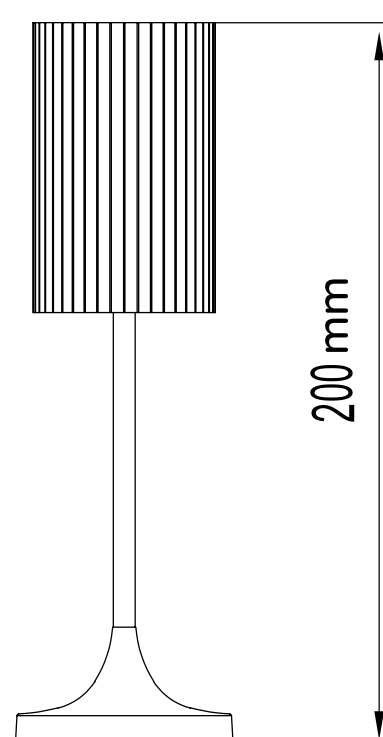
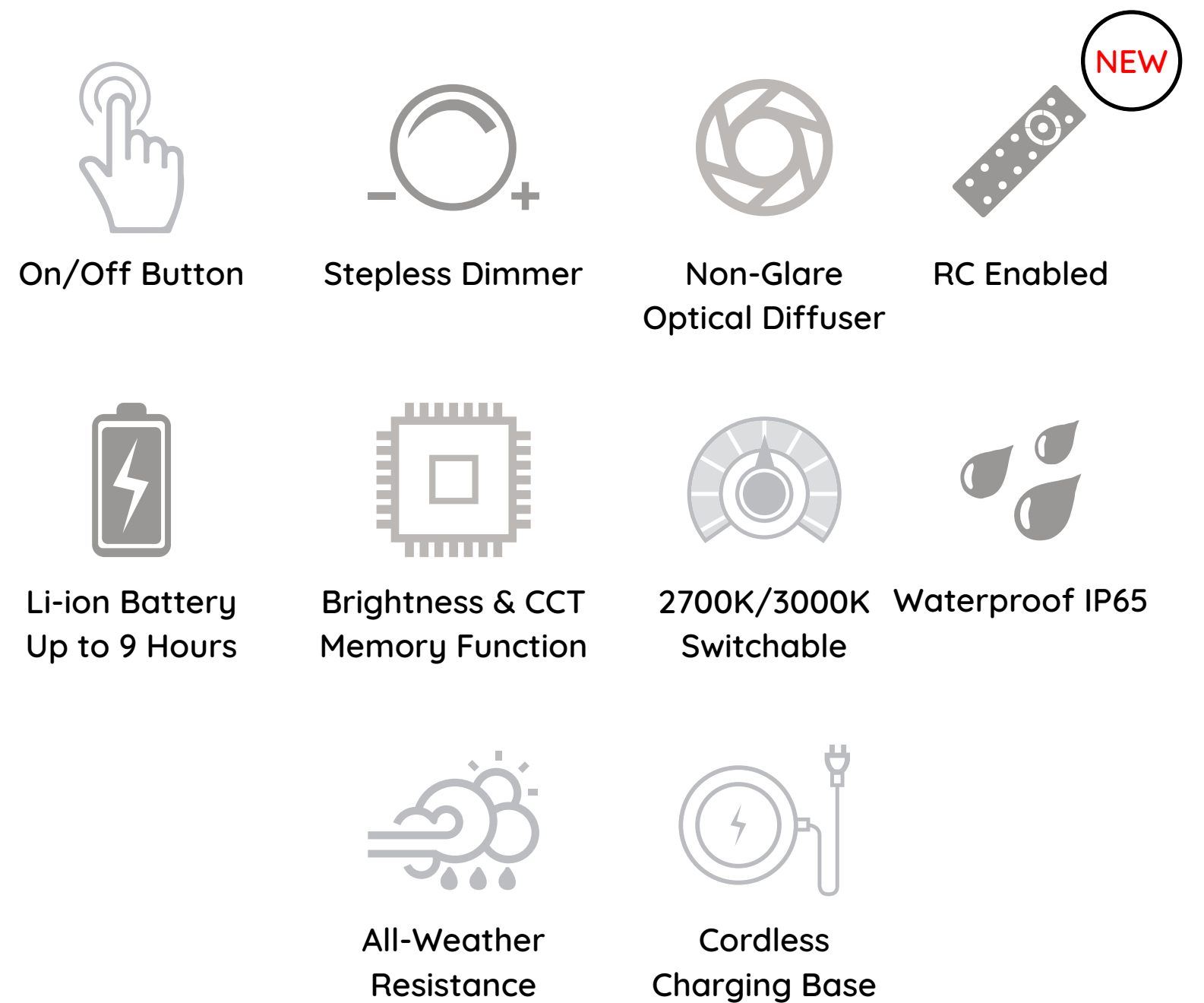

Fiore Micro F1008S-200D-RC

LED, 2200K/3000K, 2.2W, DC3.7V, with R/C function, without adaptor

Available in the following colors:

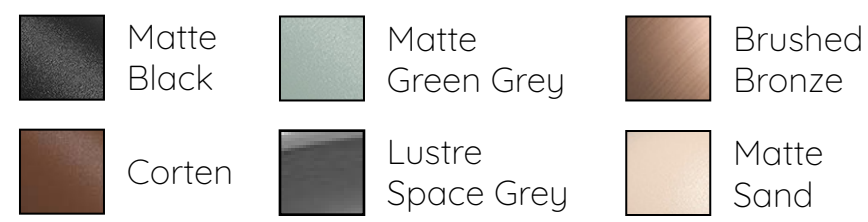

Specifications

Serial No.	F1008S-200D-RC
Material	Die-casting aluminium alloy
Safety Class	CLASS III
Ingress Protection	IP65
Dimension	Φ75*200mm
Inner box / master carton	12×9×24cm / 26×29×26cm
Net Weight	417g
Light Source	OSRAM SMD 2835
CRI	≥ 80
Power	2.2W
Input Voltage	DC 3.7V
Luminaire Flux	160lm
Switch	Touch ON/OFF, Remote Control
Color Temp.	2200K / 3000K (switchable)
Dimmer	Stepless dimmable 5%-100%
Memory Function	Memory of brightness, color temp.
Battery Type	Li-ion battery
Battery Capacity	3000mA
Battery charging time	≤ 4.5 hours
Battery working time	≥ 9 hours(100% light intensity)
Adaptor (optional)	CLASS II; Input AC100-240V; Output DC 5V1A

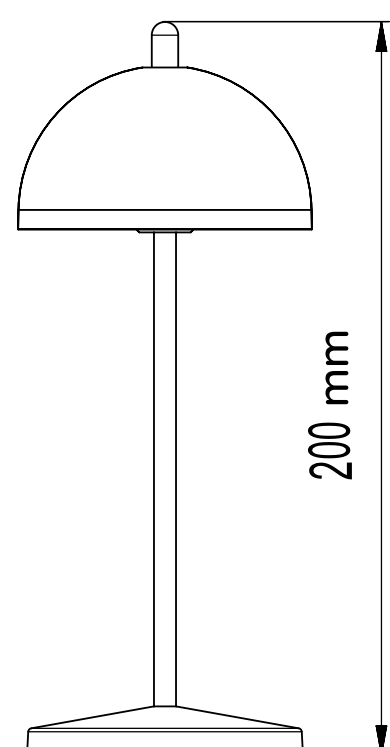
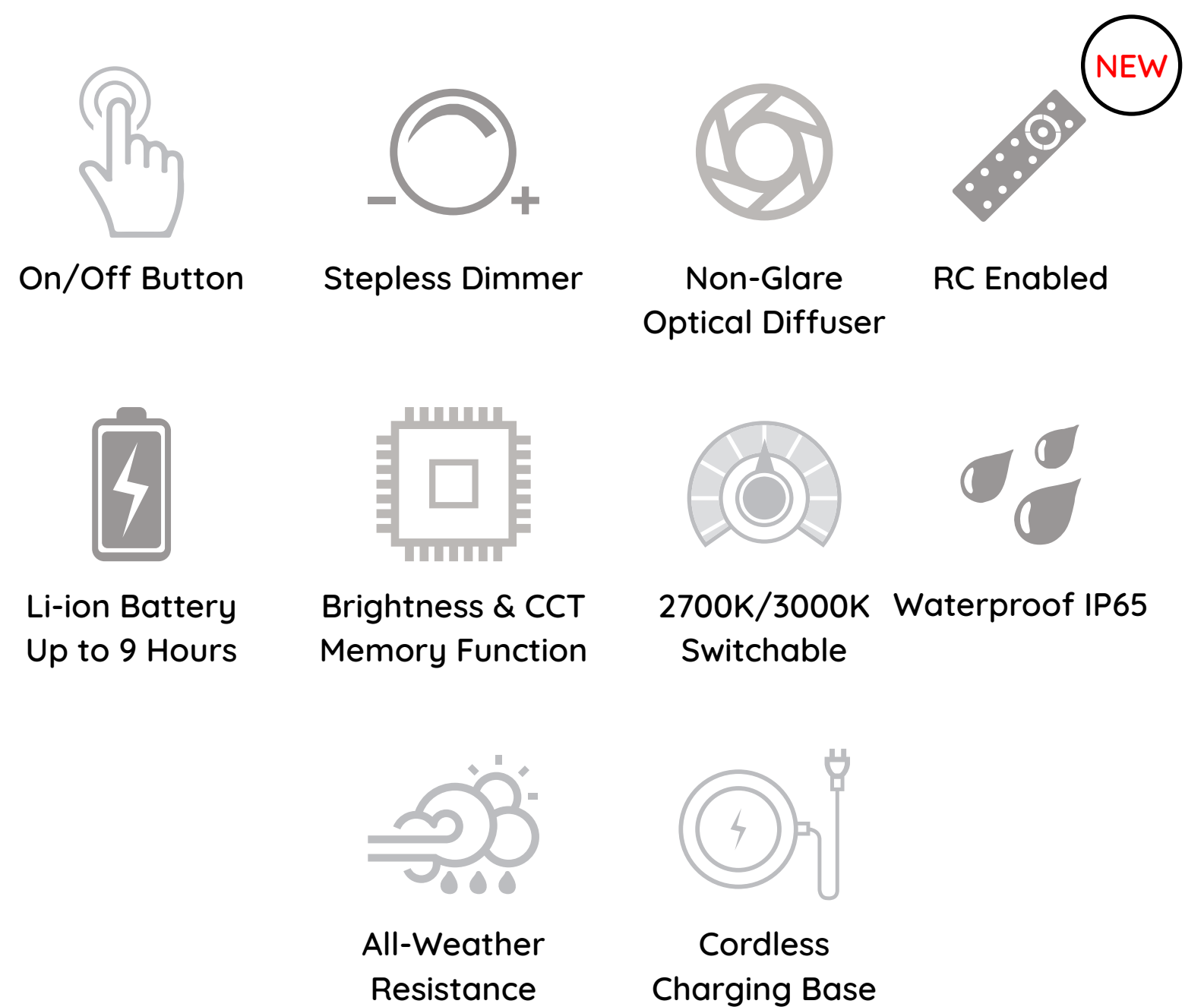

Deca 250

F1642S-250W-RC

LED, 2200K/2700K, 1.5W, DC3.7V, with RC function, without adapter

Available in the following colors:



Specifications

Serial No.	F1642S-250W-RC
Material	Die-casting aluminium alloy
Safety Class	CLASS III
Ingress Protection	IP65
Dimension	Φ85x254mm
Inner box / master carton	9.5x9.5x33.5cm / 30x20.5x35cm
Net Weight	370g
Light Source	OSRAM SMD 2835
CRI	≥ 80
Power	1.6W
Input Voltage	DC 3.7V
Luminaire Flux	148lm
Switch	Touch ON/OFF, Remote Control
Color Temp.	2200K / 2700K (switchable)
Dimmer	Stepless dimmable 5%-100%
Memory Function	Memory of brightness, color temp.
Battery Type	Li-ion battery
Battery Capacity	1500mA
Battery charging time	≤ 2.5 hours
Battery working time	≥ 6.5 hours(100% light intensity)
Adapter (optional)	CLASS II; Input AC100-240V; Output DC 5V1A

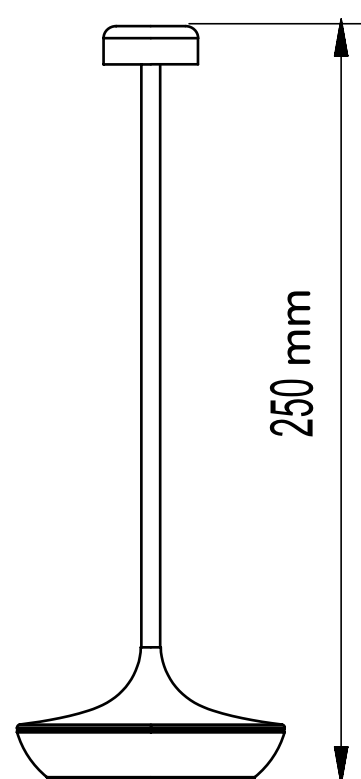
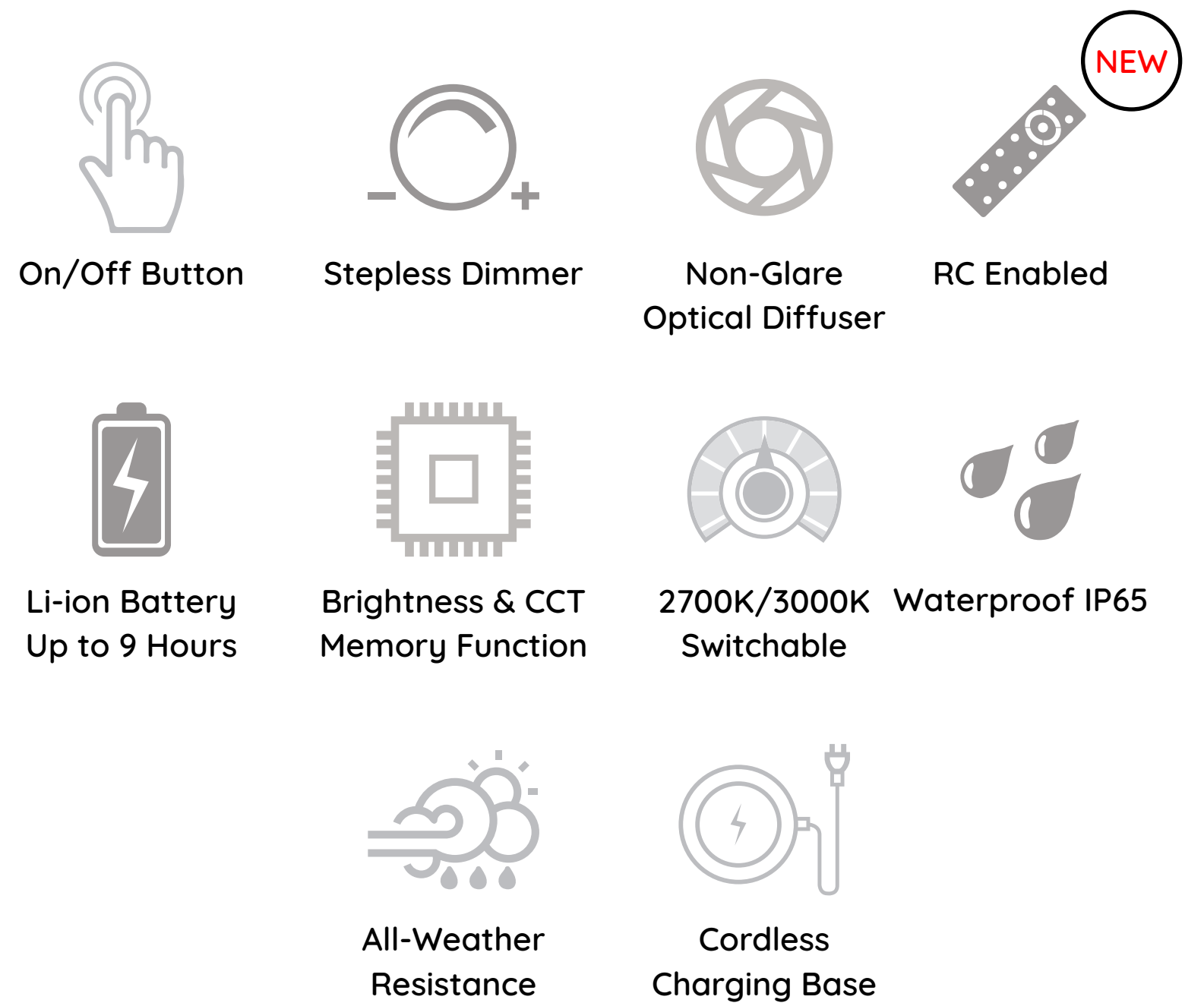

Paola 300

C1002-300-TC

SMD, 2700K, 2.2W, DC3.7V, no adapter

Available in the following colors:



Specifications

Serial No.	C1002-300-TC
Material	Die-casting aluminium alloy
Safety Class	CLASS III
Ingress Protection	IP54
Dimension	Φ113*317mm
Inner box / master carton	15×15×35cm / 47×32×37cm
Net Weight	627g
Light Source	OSRAM SMD 2835
CRI	≥ 80
Power	2.2W
Input Voltage	DC 3.7V
Luminaire Flux	234lm
Switch	Touch ON/OFF
Color Temp.	2700K
Dimmer	Stepless dimmable 5%-100%
Memory Function	Memory of brightness
Battery Type	Li-ion battery
Battery Capacity	2200mA
Battery charging time	≤ 2.5 hours
Battery working time	≥ 7.5 hours(100% light intensity)
Adapter (optional)	CLASS II; Input AC100-240V; Output DC 5V1A

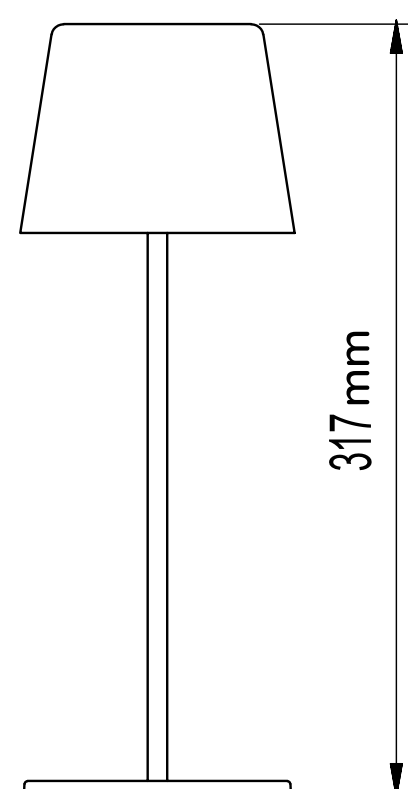
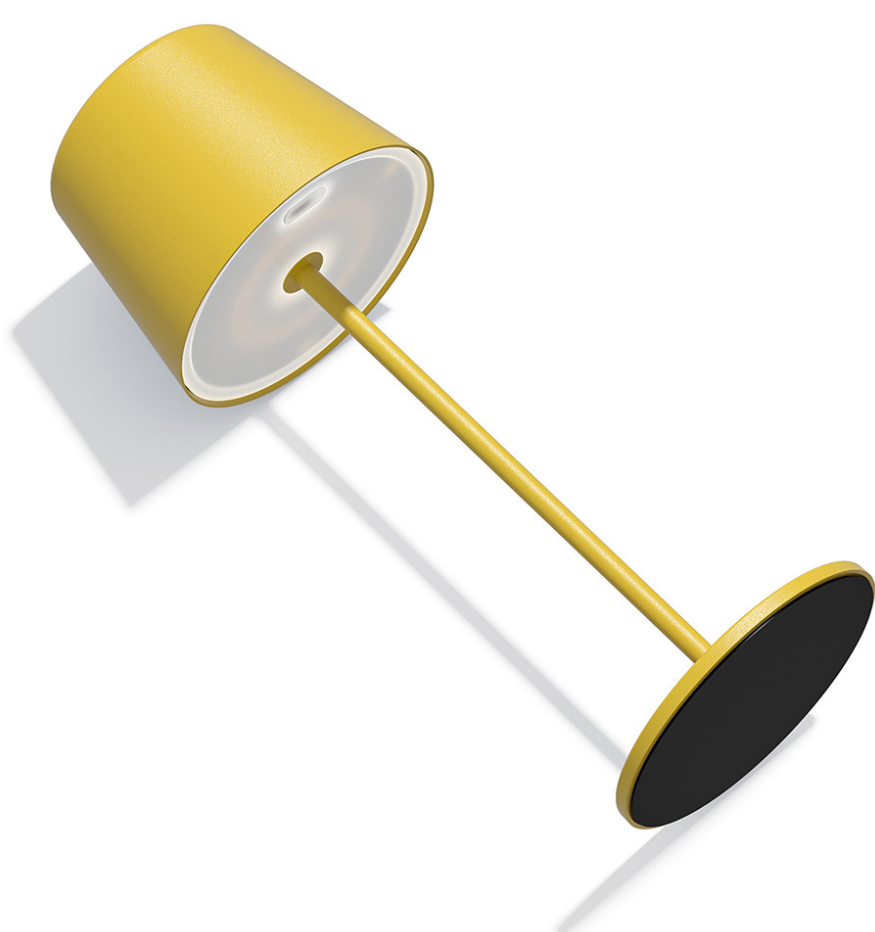
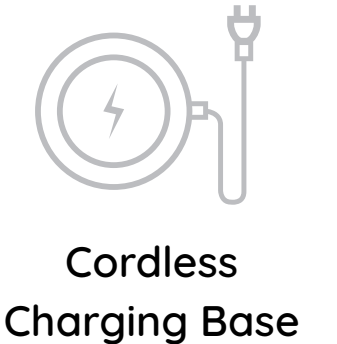
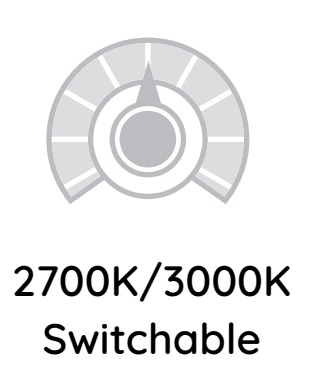
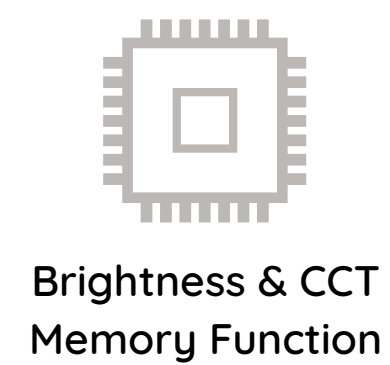
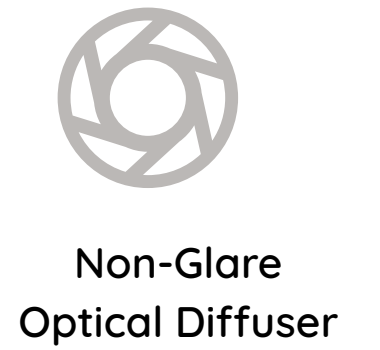

Charging Shelf A0201

Contact 6
Input Voltage AC100-240V
Power 45W
* with EU standard adaptor

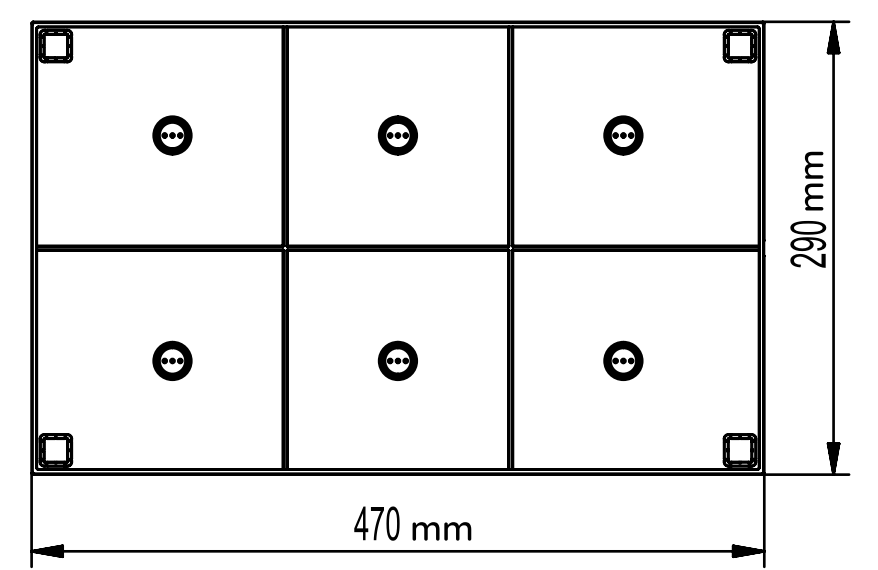
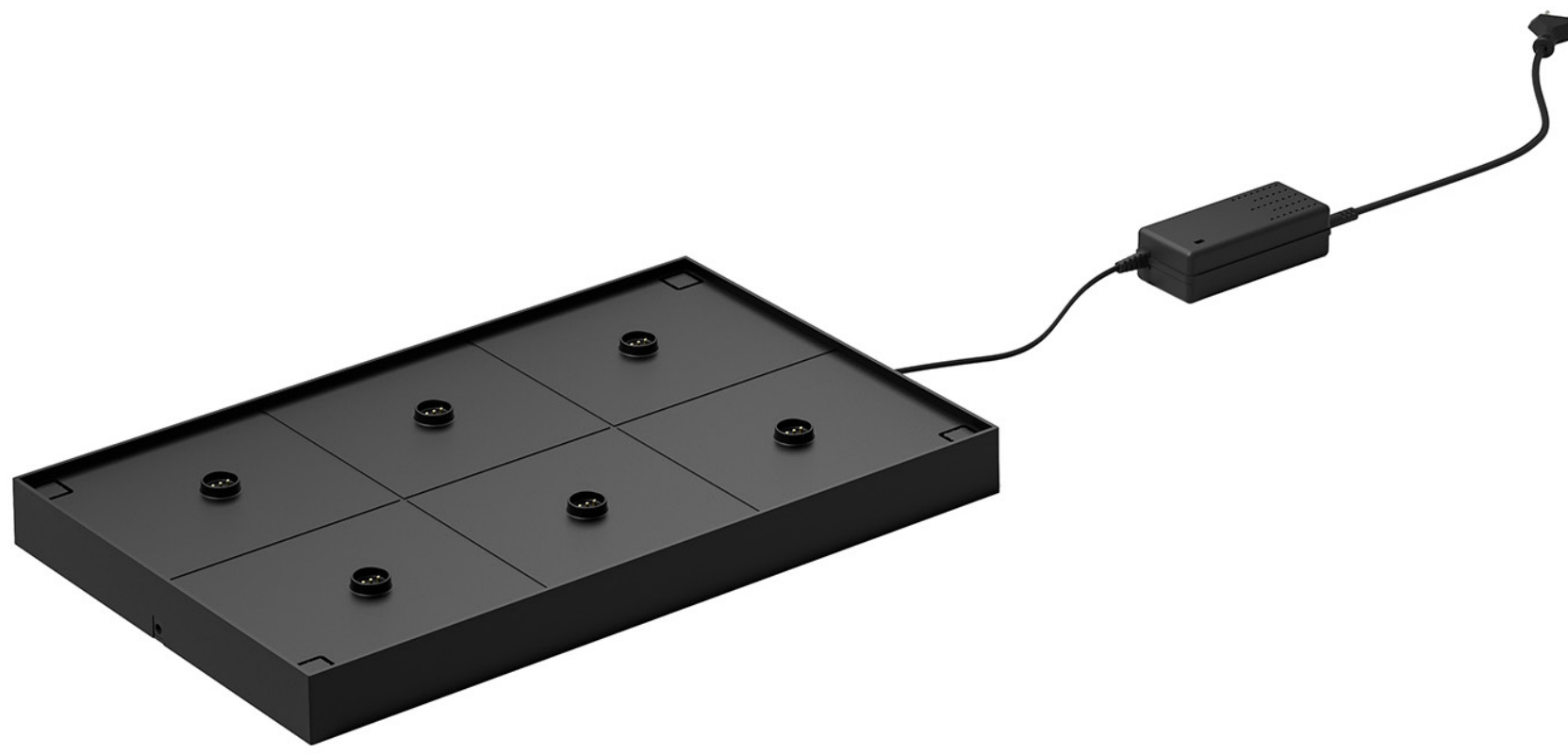

Charging Shelf A0217

Contact 15
Input Voltage AC100-240V
Power 120W
* with EU adaptor

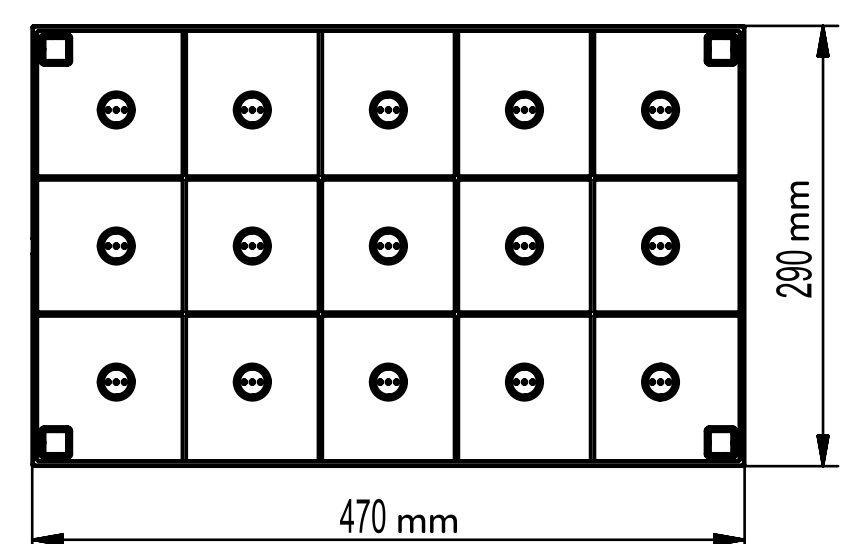
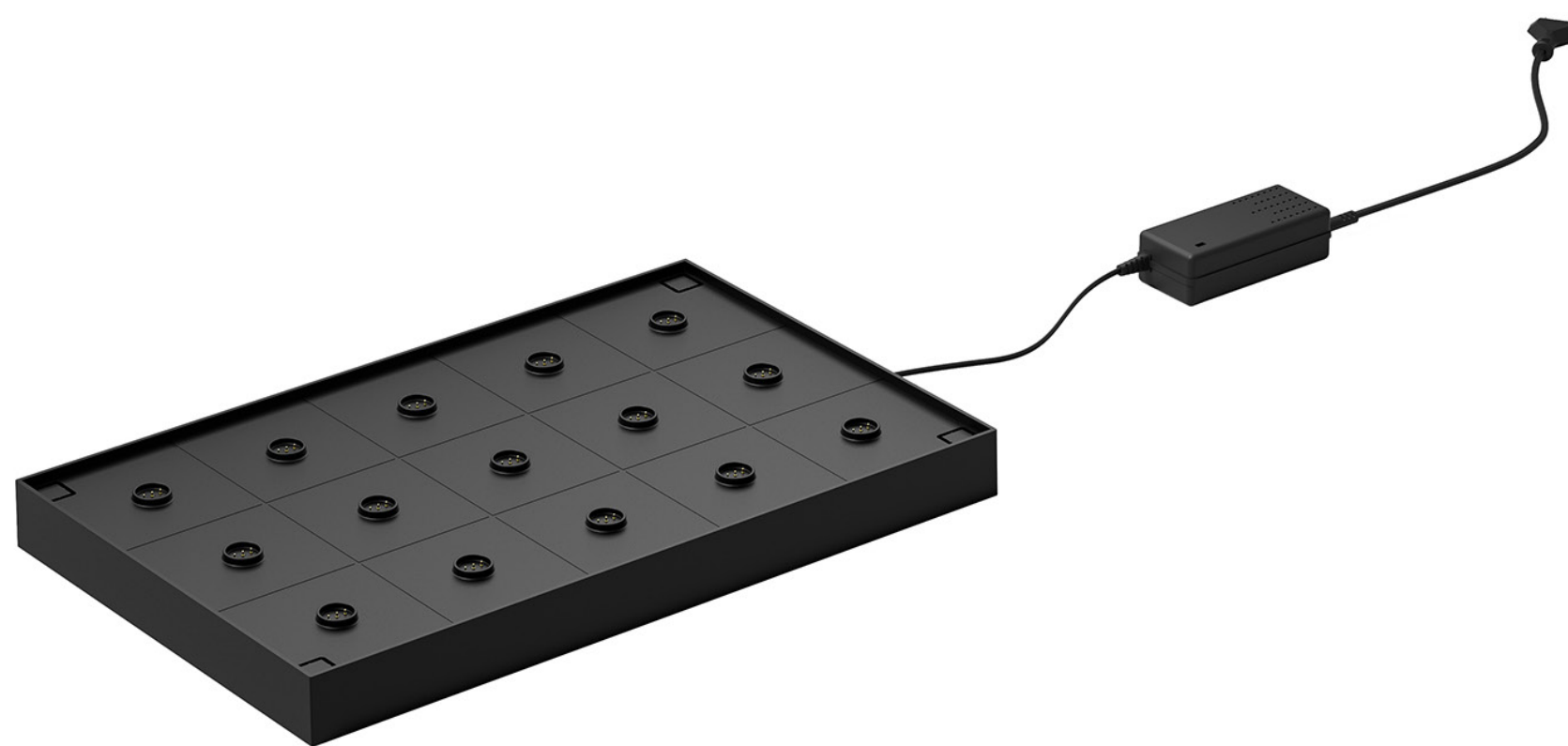

Remote Control

A0329

RF Remote Control

Input Voltage 2 * 1.5V DC

Inner Box 15x15x35cm

Master Carton 47x32x37cm

* AAA Batteries not included

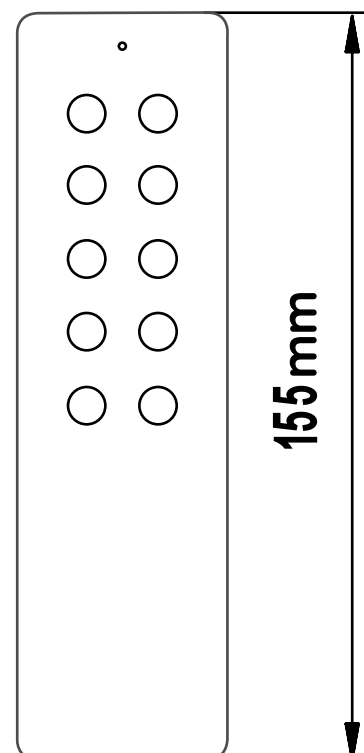

Multiple
Contact
Charging
Trolley
A0218





LAMPA 

