

INSPIRING CREATORS

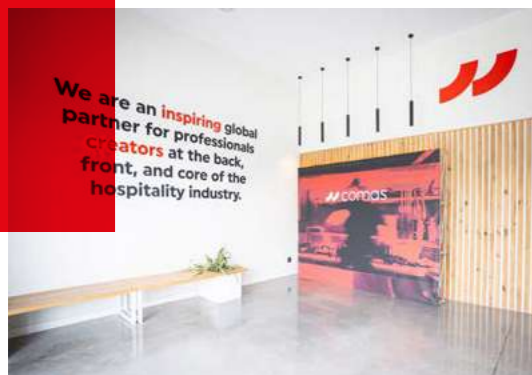

Global partner
for professional creators
at the back, front,
and core of the
hospitality industry

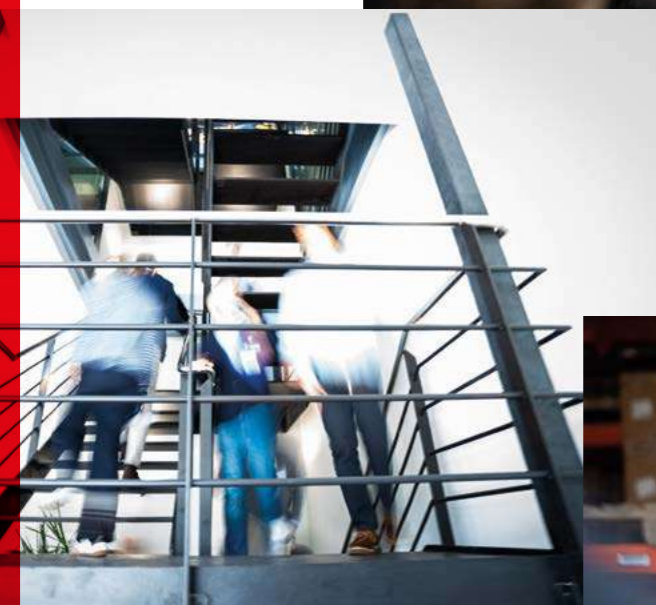

Transformación constante

Desde hace 35 años junto a los profesionales de la industria, en la sala, en la cocina y en el corazón mismo de la hostelería.

Nuestra misión es inspirar a los creadores culinarios profesionales: inspirar a quienes nos inspiran. Por esto nuestro claim es "inspiring creators".

En Comas tenemos una filosofía fundacional: dar para recibir, inspirar para crear, innovar para crecer. El cambio está en nuestro ADN.

Bienvenidos a la transformación de Comas.
Bienvenidos a nuestro catálogo 2026.

Constant transformation

For 35 years alongside industry professionals, in the dining room, in the kitchen and at the very heart of the hospitality industry.

Our mission is to inspire professional culinary creators: to inspire those who inspire us. This is why our motto is 'inspiring creators'.

At Comas, we have a founding philosophy: give to receive, inspire to create, innovate to grow. Change is in our DNA.

Welcome to the Comas transformation.
Welcome to our 2026 catalogue.

Dani Comas, PRESIDENT

1991

Origen: cubertería

El origen: la cubertería y el foco comercial.

The origin: cutlery and a commercial focus.



2019

Nuevas categorías

El crecimiento a nuevas categorías: Cocina y logística.

Growth to new categories: Cooking and logistics.



2022

Nueva sede corporativa

La consolidación. Nueva sede en Lliçà d'Amunt con nuevo almacén de 5.000 m².

Consolidation. New headquarters in Lliçà d'Amunt with a new 5,000 m² warehouse.



2025

Nueva estrategia

La excelencia. Nueva estrategia corporativa: Inspiring Creators. Nuevos almacenes por 11.000 m².

Excellence. New corporate strategy: Inspiring creators. New warehouses covering 11,000 m².

TRANSFORMATION

1996

ADN industrial

El ADN industrial. Primera fábrica de cubertería Arkaute.

Industrial DNA. First Arkaute cutlery factory.

2004

Diseño propio

El diseño propio. Nace la colección Barcelona.

Our own design. The Barcelona collection is born.



2023

Profesionalización

La profesionalización. Mejora constante en innovación, calidad y diseño.

Professionalisation. Continuous improvement in innovation, quality and design.



2026

Transformación

La transformación: nuevas categorías en el back y en el front: Ollas y vajilla.

Transformation. New categories for the back of house and front of house: Pots and tableware.



La transformación es movimiento

Para crecer de manera sostenida en nuestro negocio de cubertería y simultáneamente ampliar nuestro portafolio de productos a nuevas categorías en sala y cocina, hemos implementado un plan de transformación empresarial.

Transformation is movement

Our sustainable growth plan for the cutlery business involves expanding into new dining and kitchenware categories through a focused business transformation strategy.

Novedades en cubertería, en ollas y en sartenes.

New products in cutlery, pots and pans.

Ampliación de oferta en vajilla.

Expansion of our tableware offer.

Optimización de portafolio.

Portfolio optimisation.

Inversión continua en diseño propio e innovación

Continuous investment in in-house design and innovation

Trabajo y desarrollo junto a los maestros artesanos

Projects and developments in collaboration with master craftsmen

Incremento de los estándares de calidad y sostenibilidad.

Increased quality and sustainability standards

Inversión constante en logística y almacenamiento

Constant investment in logistics and warehousing

Profesionalización y cultura centrada en el servicio al cliente.

Professionalisation and customer service centered culture.

Generación de valor, intercambios y networking

Value creation, exchanges and networking



Novedades en cubertería, en ollas y en sartenes

Seguimos liderando el segmento de cubertería.

Apostamos por el diseño y la innovación accesible en la categoría.

Innovamos en el front con novedades en cubertería y chuleteros.

También innovamos en el back con nueva gama de ollas y sartenes.



New products in cutlery, pots and pans

We continue to lead the cutlery segment.

We are committed to design and accessible innovation in the category.

We innovate for the front of house with innovations in cutlery and steak knives.

We also innovate for the back of house with a new range of pots and pans.



Vajilla: la gran novedad / Tableware: the latest addition

Nuestra vajilla, la gran novedad Our tableware, the latest addition

La novedad más importante de este año.

La vajilla de Comas

Aceleramos nuestra participación en el mercado de vajilla con nuevas propuestas en Stoneware, porcelana y cristal.

This year's most important addition.

Comas tableware

We are stepping up our involvement in the tableware market, with new products in stoneware, porcelain and glass.



Nuestra oferta en vajilla crece y se diversifica con diseño propio y con una alianza estratégica con Piolí.

También colaborando con maestros expertos como Jordi Travería y Luesma & Vega.

Our tableware offer is growing and diversifying, with our own designs and with a strategic alliance with Piolí.

We are also collaborating with experts such as Jordi Travería and Luesma & Vega.

NEW



Portafolio

Cuatro valores fundamentales

Para garantizar coherencia, consistencia y eficiencia, reorganizamos el portafolio de producto de Comas en base a cuatro valores fundamentales que estructuran la oferta

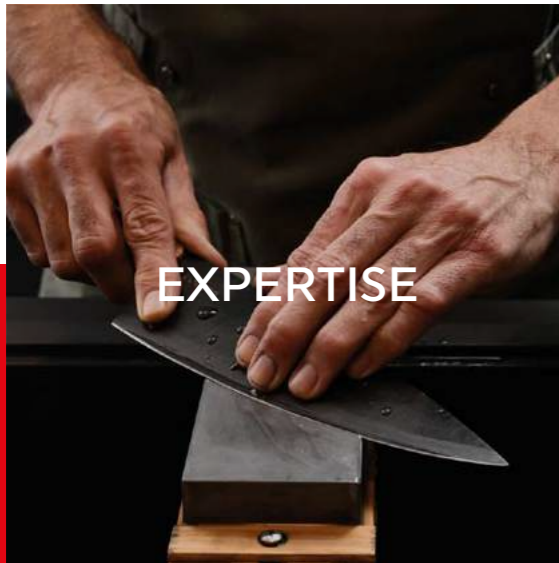

EXPERTISE: oferta de productos selectos, desarrollados de la mano de reconocidos expertos y maestros artesanos en diversas categorías. Comas escala y hace accesibles propuestas de alto valor y artesanía, en segmentos como vajilla, en corte y en brasa.

EXPERTISE: offering select products, developed by renowned experts and master craftsmen in various categories. Comas scales and makes accessible proposals of high value and craftsmanship, in segments such as dinnerware, knives and grillware.



DISEÑO PROPIO: la apuesta de Comas por el diseño exclusivo y la innovación, haciendo accesibles piezas y colecciones únicas en cubertería, corte, vajilla y soluciones de catering. Trabajando con equipos de diseño propio y diseñadores reconocidos, en la búsqueda de lo diferencial y relevante.

OWN DESIGN: Comas' commitment to exclusive design and innovation, making accessible unique pieces and collections in cutlery, knives, tableware and catering solutions. Working with our own design teams and renowned designers, in pursuit of what is distinctive and relevant.



UNIVERSALIDAD: el compromiso de Comas por seguir acercando al mercado soluciones estándar con el mejor equilibrio posible de precio y calidad, que demuestran la vocación de Comas por la funcionalidad, cercanía y accesibilidad para todos los segmentos.

UNIVERSALITY: Comas' commitment to continue bringing standard solutions to the market with the best possible price-quality balance, demonstrating Comas' dedication to functionality, proximity and accessibility for all segments.



COMPROMISO: la vocación de Comas de ir más allá. Comas acerca al mercado nuevas propuestas de valor de marcas reconocidas que complementan y completan su catálogo de producto propio, a través de alianzas estratégicas y colaboraciones en vajilla, cocina y logística

COMMITMENT: Comas' dedication to go beyond. Comas brings new value propositions from recognised brands to the market that complement and complete its own product catalogue, through strategic alliances and partnerships in tableware, cooking and logistics

Portfolio

Four core values

To ensure coherence, consistency and efficiency, we reorganised Comas' product portfolio based on four core values to structure the offer

Inversión continua en diseño Continuous investment in design

Seguimos apostando por el valor y la originalidad de nuestras piezas únicas, innovando en la producción y logrando líneas de diseño reconocidas por el mercado junto a reconocidos equipos de diseño

We remain committed to the value and originality of our unique pieces, innovating in production and achieving market recognized design line in collaboration with revowed design teams



PABLO CASTILLO

NACAR

NIL CARBÓ



CHRISTOPHE MATHIEU



LÚCID



ULI MARCHSTEINER



BAHIGÜELL



ELISAVA

Escuela Universitaria de Barcelona
Diseño e Ingeniería

Trabajando de la mano de diseñadores consolidados, nuevos talentos, universidades y expertos, descubrimos y creamos nuevas formas, nuevos conceptos y nuevos materiales.

Juntos ampliamos los límites de lo que hoy es posible, construyendo un futuro mejor, más inspirador y más creativo.

Working hand in hand with established designers, emerging talents, universities, and experts, we discover and create new forms, new concepts, and new materials.

Together, we push the boundaries of what's possible today, building a better, more inspiring, and more creative future.

Premios Awards



El valor de lo artesanal

The value of craftsmanship

Inversión continua en diseño propio, innovación y expertise: trabajando la mano de expertos, colaborando con ellos para seguir aprendiendo y escalar el saber y dedicación artesanal, a un estándar industrial de calidad.

Junto a ellos y a los profesionales del sector crecemos y ganamos experiencia en el mundo de la vajilla, corte y brasa.

Continuous investment in our own design, innovation and expertise: working hand in hand with experts, collaborating with them to continue learning and scaling artisanal knowledge and dedication to an industrial standard of quality.

Together with them and the professionals in the sector, we grow and gain experience in the world of dinnerware, knives and grillware.

UTSET

Utset, empresa familiar con 130 años de dedicación a la fabricación, venta y afilado de cuchillos de alta calidad.

Utset, a family business with 130 years of dedication to the manufacture, sale and sharpening of high-quality knives.



Travería

Jordi Travería, artista y artesano multifacético, experto en cerámica, vidrio, piezas artísticas y gastronómicas.

Jordi Travería, multifaceted artist and craftsman, expert in ceramics, glass, and artistic and gastronomic pieces.



LUESMA VEGA

Luesma & Vega, estudio dedicado al diseño y producción de objetos artísticos en vidrio, para el mundo gastronómico.

Luesma & Vega, a studio dedicated to the design and production of artistic objects in glass, for the gastronomic world.



bahígüell

Bahígüell, agencia de diseño de producto con la que unimos fuerzas para el desarrollo industrial y escalabilidad de la propuesta de soluciones en brasa Caliu.

Bahígüell, product design agency with which we joined forces for the industrial development and scalability of the Caliu grilling solutions proposal.



Llenyes i Carbons del Valles, empresa dedicada a la selección y manipulación de carbones y leñas selectas para profesionales de la restauración. bilidad para todos los segmentos.

Llenyes i Carbons del Valles, a company dedicated to the selection and handling of selected charcoal and firewood for catering professionals. Reliability in all segments.



Renovamos el compromiso ISO: ISO 9001, ISO 14001.
We have renewed our ISO commitment:
ISO 9001, ISO 14001.

Compromiso

Calidad, sostenibilidad y logística

Incremento de los estándares de calidad y sostenibilidad: elevando nuestros criterios de calidad, innovando en la producción para lograr mejores resultados. Aplicando las medidas de gestión para reducir el impacto de nuestra empresa en el medioambiente. Renovamos el compromiso ISO: ISO 9001, ISO 14001.

Inversión en logística y almacenamiento. Duplicando capacidad en almacenes, en los últimos 5 años, llegando actualmente a más de 11.000 m².



Commitment

Quality, sustainability and logistics

Increased quality and sustainability standards: raising our quality criteria, innovating in production to achieve better results. Applying management measures to reduce our company's impact on the environment. We have renewed our ISO commitment: ISO 9001, ISO 14001.

Investment in logistics and warehousing. Doubling warehouse capacity in the last 5 years, currently reaching more than 11,000 m².

Equipo Team

Profesionalización de equipo

Ampliando el equipo, profesionalizando sus funciones y áreas de responsabilidad. Creciendo con diversidad y aportando mayor amplitud de experiencias en la toma de decisiones.

Trabajando junto a nuestro chef corporativo para entender en mayor profundidad las necesidades de nuestros clientes profesionales finales y optimizar nuestra oferta.

Professionalisation of the team

Expanding the team, professionalising its functions and areas of responsibility. Growing with diversity and providing greater broad range of experiences in decision-making.

Working together with our corporate chef to better understand the needs of our end professional customers and optimise our offer.



Profundización en la cultura de servicio centrado en cliente

Implementando mejoras y optimizando tiempos de entrega, acuerdos comerciales, automatización de procesos y puntos de contacto para hacer más fácil la vida de nuestros clientes.



Deepening the culture of customer-centred service

Implementing improvements and optimising delivery times, commercial agreements, process automation and contact points to make our customers' lives easier.

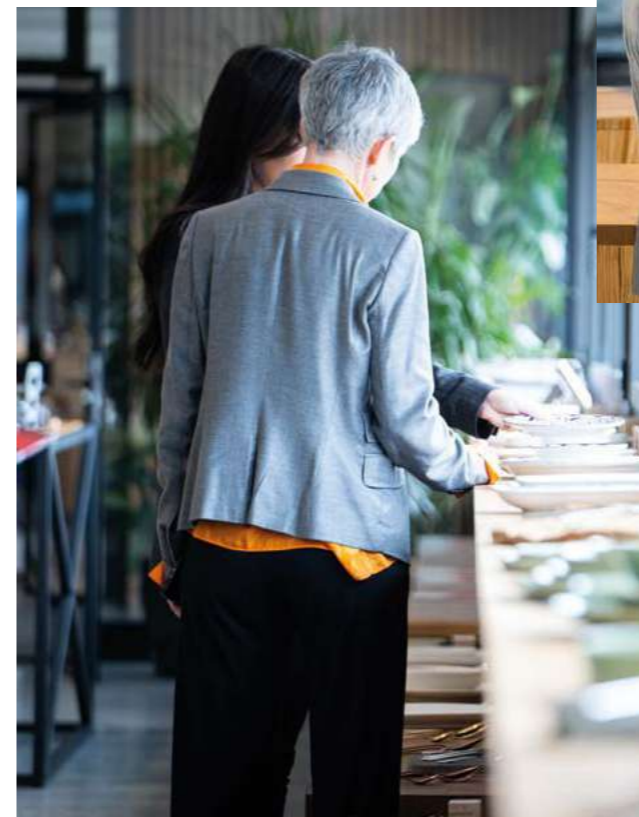

Netcooking sessions



Fomentando la generación de valor para todo el ecosistema profesional

Incrementamos nuestros intercambios y nuestra capilaridad con todo el sistema de colaboradores y stakeholders. Invertiendo en eventos de networking y sesiones colaborativas.

Tejiendo nuevas alianzas con nuestro ecosistema de partners, distribuidores, diseñadores, artesanos y fabricantes.

Fostering value creation for the entire professional ecosystem

We have increased our exchanges and our capillarity with the entire system of collaborators and stakeholders. Investing in networking events and collaborative sessions.

Fostering new alliances with our ecosystem of partners, distributors, designers, artisans and manufacturers.

PRESENCIA / PRESENCE

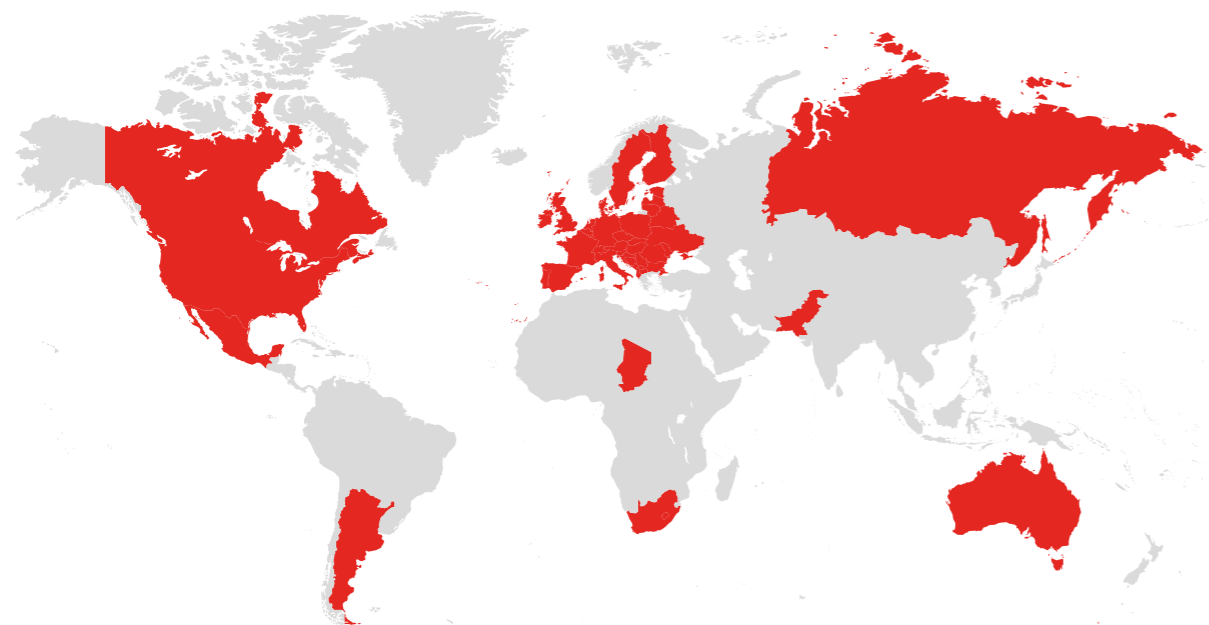

PRESENTES EN 57 PAÍSES / PRESENT IN 57 COUNTRIES

57

Germany, Belgium, Bulgaria, Burkina Faso, Cyprus, Croatia, Spain, United States of America, France, Greece, Hungary, Italy, Jordan, Lebanon, Lithuania, Luxembourg, Malta, Morocco, Mexico, Netherlands, Panama, Poland, Portugal, Andorra, U.K, Ireland, Slovakian, Rep., Dominican Rep., Reunion, Romania, Russia, Sweden, Tunisia, Ukraine, U.A.E, Austria, Chile, Denmark, Estonia, Georgia, Hong Kong, Iceland, Latvia, Moldova, Norway, Czech Republic, South Africa, Switzerland, Australia, Korea, Saudi Arabia, China, Peru, Finland, Kuwait, Sri Lanka.

CIFRAS / FIGURES

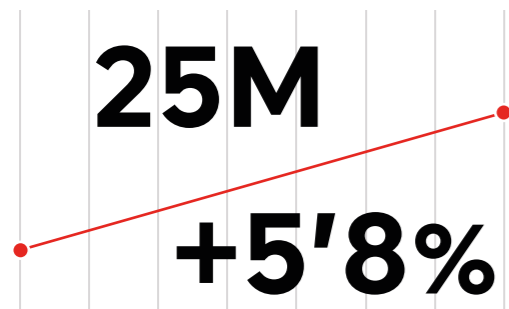

Previsión de crecimiento del 5,8% en 2025.
Previsión de facturación de 25 M.

Expected growth of 5,8% in 2025.
Forecast turnover of 25 M.

MERCADOS: 45% EXPORTACIÓN
MARKETS: 45% EXPORT



45%

Internacional
International

55%

España
Spain

ALMACÉN / WAREHOUSE

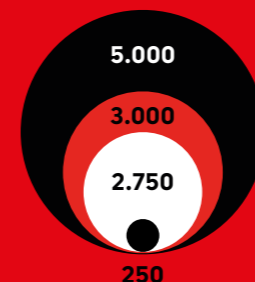

11.000 m²

Almacén central de 5.000 m². Anexo 2.750 m². Almacén en BCN con capacidad para 10.000 palés. Almacén en Canarias de 250 m². 2 almacenes en China que suman 3.000 m² (Guangzhou y Tianjin)

Central warehouse of 5,000 m². Annex 2,750 m² Warehouse in BCN with capacity for 10,000 pallets. Warehouse in the Canary Islands of 250 m². 2 warehouses in China totaling 3,000 m² (Guangzhou and Tianjin).

OFICINA EN CHINA
OFFICE IN CHINA



CHN

Nueva oficina en China (Guangzhou)
New office in China (Guangzhou)

60% STOCK SOBRE VENTAS
60% STOCK OVER SALES

+1800 DISTRIBUIDORES
+1800 DISTRIBUTORS

60%



95% de pedidos servidos en máximo 48 horas.
95% of orders served in maximum 48 hours.

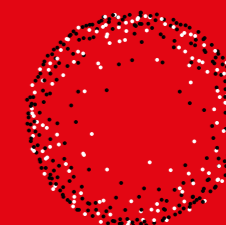

1.800

91 EMPLEADOS / EMPLOYEES

91

55 empleados internos
55 internal employees

36 comerciales externos
36 external sales staff





Front

- 34 **Cubiertos** / Cutlery
- 190 **Chuleteros** / Steak knives
- 226 **Vajilla** / Tableware
- 278 **Table top**



Back

- 308 **Ollas** / Pots
- 316 **Sartenes** / Pans
- 326 **Corte** / Knives
- 368 **Utensilios** / Utensils
- 378 **GN**
- 392 **Brasa** / Grill

Catering & Buffet

- 410 **Les Essences**
- 422 **Caja madera** / Wooden Box
- 423 **Elegant**
- 428 **Pinzas** / Tongs

Logistics

- 434 **Racks**
- 440 **Contenedores isotérmicos** / Isothermal containers





CUBIERTOS CUTLERY

INOX 18/10

18/10 STAINLESS STEEL

- | | | |
|--------------------------------------|---------------------------|-----------------------------|
| 38 ATLÁNTIDA | 108 INGLÉS XL | 103 NORTH S |
| 106 BAGUETTE S | 65 IRIS | 100 NORTH XL |
| 104 BAGUETTE XL | 52 KODAI VINTAGE | 98 ONLINE |
| 114 BARCELONA | 54 KODAI COLORS | 62 OSLO |
| 75 CALLAS | 42 LAB | 64 OSLO OCEAN FREE |
| 92 CHEF | 48 LAB ACCESSORIES | 50 SAKURA |
| 68 CONTOUR | 45 LAB COLORS | 72 SANGIOVESE |
| 70 CONTOUR GOLD | 84 LONDON | 74 SANGIOVESE GOLD |
| 66 DALIA | 86 LONDON VINTAGE | 34 TACT |
| 58 FLEUR DE LYS | 93 LOTUS | 79 TULIP |
| 60 FLEUR DE LYS VINTAGE BLACK | 80 MARANTA | 76 VERSAILLES |
| 96 IBIZA | 82 MARANTA VINTAGE | 78 VERSAILLES COPPER |
| 110 INGLÉS M | 94 MUNICH | 112 VIENA |
| 111 INGLÉS S | 102 NORTH M | 88 VIOLET |

INOX 18%

18% STAINLESS STEEL

- | | | |
|----------------------------------|----------------------------|----------------------------|
| 180 1001 | 140 CHEF FREE | 150 MADRID |
| 137 1001 BLACK | 152 CUBA | 124 MALVARROSA |
| 182 1003 | 179 ECO | 154 MIA |
| 170 ALIDA | 136 FINGER FOOD | 183 NERVIO |
| 183 ARABICA | 164 GRANADA S | 126 NICE |
| 120 BCN COLORS | 162 GRANADA XL | 169 OLYMPIA |
| 118 BCN SATIN | 148 HIDRAULIC | 125 OSLO ECO |
| 168 BILBAO S | 177 HOTEL | 138 SANTORINI |
| 166 BILBAO XL | 176 HOTEL EXTRA ECO | 160 SEVILLA S |
| 178 BROOKLYN | 174 HOTEL EXTRA M | 161 SEVILLA VINTAGE |
| 128 CANADA | 173 HOTEL EXTRA XL | 158 SEVILLA XL |
| 130 CANADA VINTAGE | 142 KYOTO | 157 VIEUX PARIS |
| 131 CANADA VINTAGE COLORS | 143 LINO | 90 VIOLET COLORS |
| 144 CHEESE | 141 LOTUS FREE | 89 VIOLET SATIN |
| 145 CHEESE COLORS | 172 LUNA | |

OTROS

OTHERS

- 188** FINISHES - PVD
- 184** REPOSA CUBIERTOS
- 178** TAKE AWAY

Tact

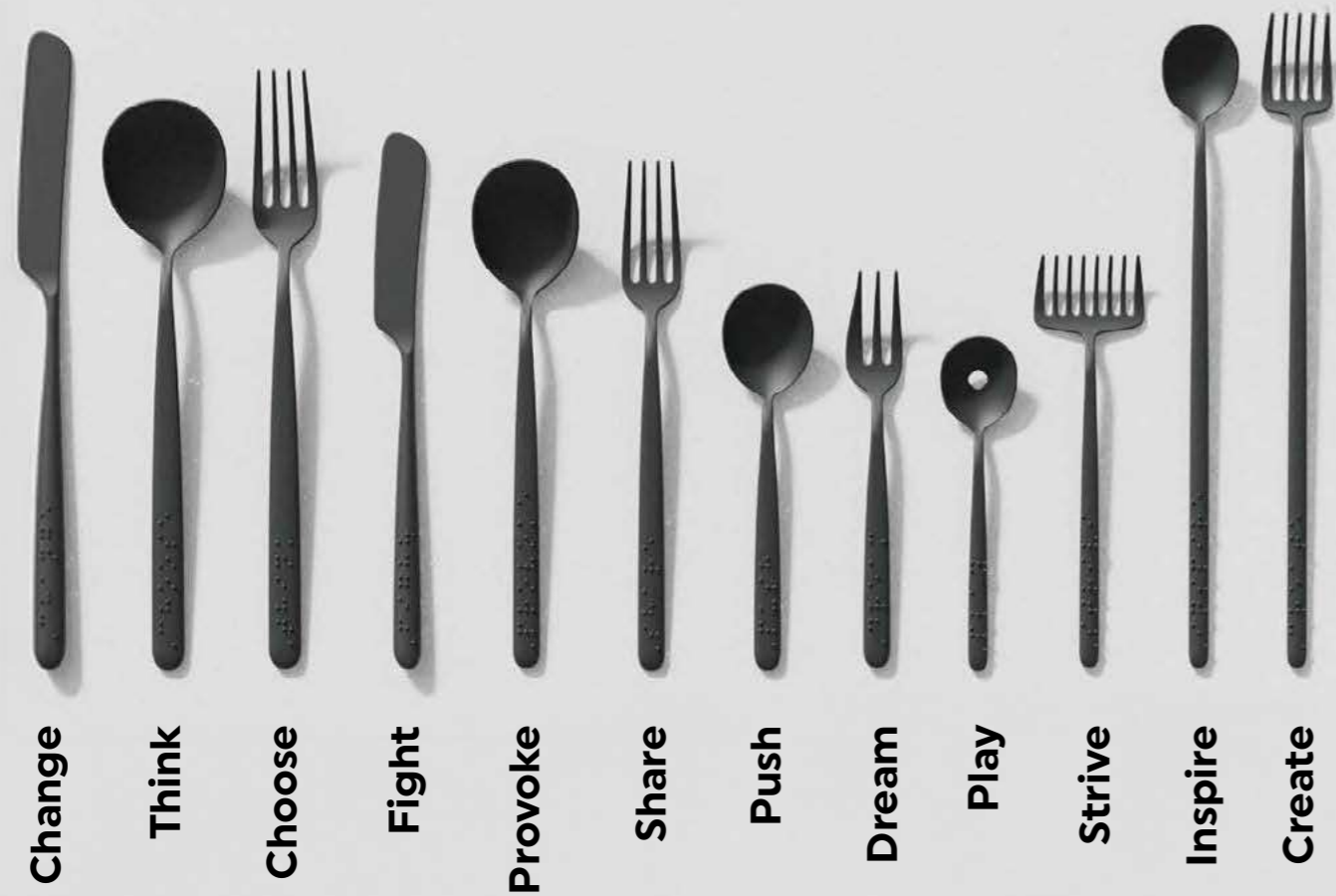

Otra manera de comunicarse. Otra manera de sentir.

Another way to communicate. Another way to feel.



La colección Tact es una llamada a la acción. Se trata de una propuesta provocadora que refleja la forma de hacer de Comas: inspirar, crear y proponer siempre nuevos caminos.

Diseñada junto a Pablo Castillo, Tact propone maximizar nuestra sensorialidad. Su nombre refiere al tacto. Una familia de líneas suaves y curvas generosas, que contrastan con la rugosidad en mano producida por el relieve del mensaje en Braille.

Tact esconde mensajes a ser descifrados: cambia, piensa, elige, lucha, provoca, comparte, juega, esfuérzate. Y como no podía ser de otra manera para nosotros: Inspira, crea.

Un recuerdo a que siempre existen otros lenguajes.

The Tact collection is a call to action. It is a provocative concept that reflects Comas' approach: always inspiring, creating and forging new paths.

Designed together with Pablo Castillo, Tact aims to maximise our sensory appeal. Its name refers to the sense of touch. A family of smooth lines and generous curves, contrasting with the rougher, raised texture created by the Braille message.

Tact hides messages to be deciphered: change, think, choose, fight, provoke, share, play, strive. And, of course: Inspire, create.

A reminder that there are always other languages.

TACT VINTAGE

INOX 18/10 / 4mm / Vintage

NEW

NEW

TACT VINTAGE BLACK

INOX 18/10 / 4mm / Vintage Black

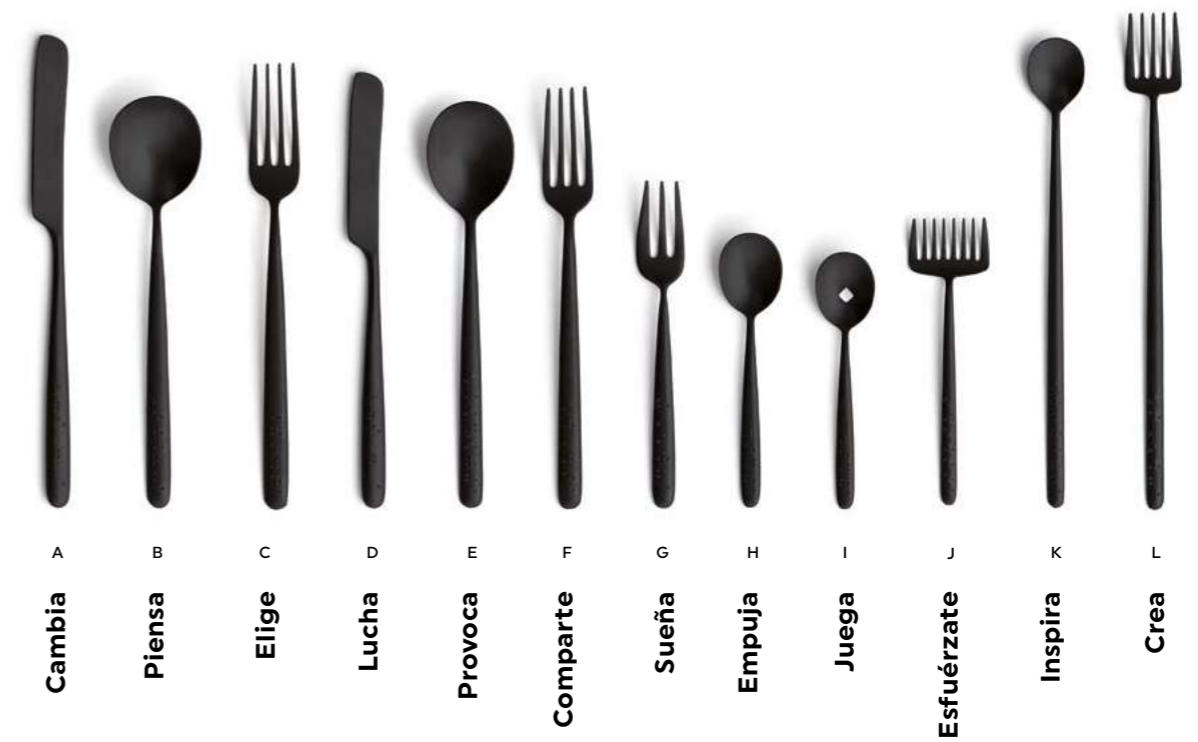
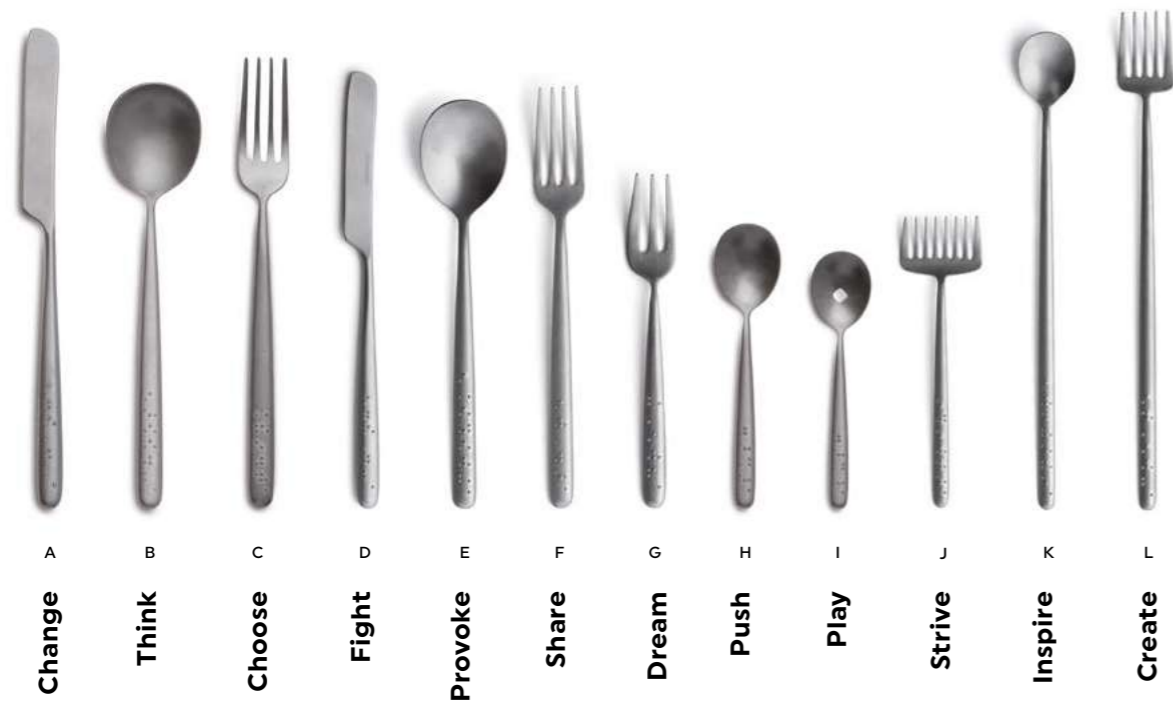

REF.	Descripción	€	UE/MOQ	▶ mm	✂ mm
A 12327	Cuchillo Mesa Table Knife, Couteau Table, Coltello Tavola, Tafelmesser	3,12 €	12-120 / 12	220	
B 12328	Cuchara Mesa Table Spoon, Cuillère Table, Cucchiao Tavola, Tafellöffel	2,70 €	12-120 / 12	197	4
C 12329	Tenedor Mesa Table Fork, Fourchette Table, Forchetta Tavola, Tafelgabel	2,70 €	12-120 / 12	206	4
D 12330	Cuchillo postre Dessert Knife, Couteau Dessert, Coltello Frutta, Dessertmesser	2,90 €	12-120 / 12	185	
E 12331	Cuchara Postre Dessert Spoon, Cuillère Dessert, Cucchiao Frutta, Dessertlöffel	2,47 €	12-120 / 12	176	4
F 12332	Tenedor Postre Dessert Fork, Fourchette Dessert, Forchetta Frutta, Dessertgabel	2,47 €	12-120 / 12	176	4
G 12333	Tenedor Lunch Cake Fork, Fourchette Gâteau, Forchetta Dolce, Kuchengabel	1,86 €	12-120 / 12	137	3,5
H 12334	Cuchara Café Tea Spoon, Cuillère Café, Cucchiao Caffé, Kaffeelöffel	1,86 €	12-120 / 12	134	3,5
I 12335	Cuchara Moka Coffee/Moka Spoon, Cuillère Moka, Cucchiao Moka, Mokkalöffel	2,18 €	12-120 / 12	116	3
J 12336	Rastrillo Wide Fork, Fourchette Râteau, Forchetta Wide, Taffelgabel Wide	1,98 €	12-120 / 12	142	3
K 12337	Cuchara Cocktail Cocktail Spoon, Cuillère à cocktail, Cucchiao da cocktail, Cocktaillöffel	2,22 €	12-120 / 12	220	3
L 12338	Tenedor Cocktail Cocktail Fork, Fourchette à cocktail, Forchetta da cocktail, Cocktailgabel	2,22 €	12-120 / 12	225	3



REF.	Descripción	€	UE/MOQ	▶ mm	✂ mm
A 12339	Cuchillo Mesa Table Knife, Couteau Table, Coltello Tavola, Tafelmesser	4,46 €	12-120 / 12	220	
B 12340	Cuchara Mesa Table Spoon, Cuillère Table, Cucchiao Tavola, Tafellöffel	4,05 €	12-120 / 12	197	4
C 12341	Tenedor Mesa Table Fork, Fourchette Table, Forchetta Tavola, Tafelgabel	4,05 €	12-120 / 12	206	4
D 12342	Cuchillo postre Dessert Knife, Couteau Dessert, Coltello Frutta, Dessertmesser	4,25 €	12-120 / 12	185	
E 12343	Cuchara Postre Dessert Spoon, Cuillère Dessert, Cucchiao Frutta, Dessertlöffel	3,82 €	12-120 / 12	176	4
F 12344	Tenedor Postre Dessert Fork, Fourchette Dessert, Forchetta Frutta, Dessertgabel	3,82 €	12-120 / 12	176	4
G 12345	Tenedor Lunch Cake Fork, Fourchette Gâteau, Forchetta Dolce, Kuchengabel	3,20 €	12-120 / 12	137	3,5
H 12346	Cuchara Café Tea Spoon, Cuillère Café, Cucchiao Caffé, Kaffeelöffel	3,20 €	12-120 / 12	134	3,5
I 12347	Cuchara Moka Coffee/Moka Spoon, Cuillère Moka, Cucchiao Moka, Mokkalöffel	3,53 €	12-120 / 12	116	3
J 12348	Rastrillo Wide Fork, Fourchette Râteau, Forchetta Wide, Taffelgabel Wide	3,33 €	12-120 / 12	142	3
K 12349	Cuchara Cocktail Cocktail Spoon, Cuillère à cocktail, Cucchiao da cocktail, Cocktaillöffel	3,57 €	12-120 / 12	220	3
L 12350	Tenedor Cocktail Cocktail Fork, Fourchette à cocktail, Forchetta da cocktail, Cocktailgabel	3,57 €	12-120 / 12	225	3



ATLÁNTIDA MIRROR

INOX 18/10 / 6mm / Mirror

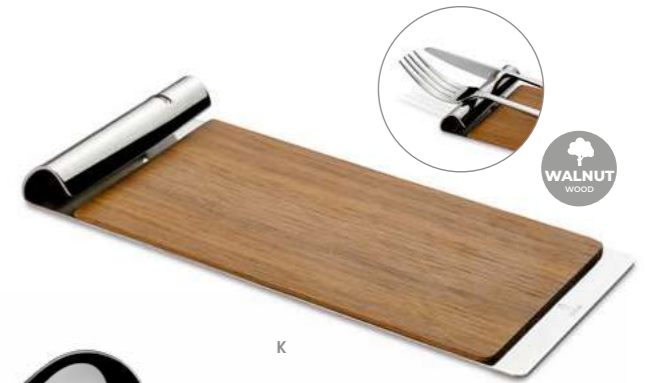

Everest + Atlántida



REF.	Descripción	€	UE/MOQ	▶ mm	✂ mm
------	-------------	---	--------	------	------

A	11582 Cuchillo Chuletero Everest Steak Knife, Couteau Steak, Coltello Bistecca, Steakmesser	4,00 €	6-60 / 6	220	
B	11583 Tenedor Chuletero Everest Steak Knife, Couteau Steak, Coltello Bistecca, Steakmesser	3,45 €	6-60 / 6	206	6
C	8586 Cuchillo Mesa Table Knife, Couteau Table, Coltello Tavola, Tafelmesser	5,51 €	6-60 / 6	226	
D	8587 Cuchara Mesa Table Spoon, Cuillère Table, Cucchiaio Tavola, Tafellöffel	5,97 €	6-60 / 6	215	6
E	8588 Tenedor Mesa Table Fork, Fourchette Table, Forchetta Tavola, Tafelgabel	6,07 €	6-60 / 6	218	6
F	8656 Cuchara Salsa Sauce Spoon, Cuillère A Sauce, Cuchiaio Salsa, Saucenlöffel	6,42 €	6-60 / 6	216	6
G	8589 Cuchillo Lunch Cake Knife, Couteau Gâteau, Coltello Dolce, Kuchenmesser	4,96 €	6-60 / 6	169	
H	8591 Cuchara Lunch Cake Spoon, Cuillère Gâteau, Cucchiaio Dolce, Lunch Löffel	4,30 €	6-60 / 6	163	5
I	8590 Tenedor Lunch Cake Fork, Fourchette Gâteau, Forchetta Dolce, Kuchengabel	4,35 €	6-60 / 6	160	5
J	8592 Cuchara Café Coffee/Moka Spoon, Cuillère Moka, Cuchiaio Moka, Mokkalöffel	2,33 €	6-60 / 6	109	3,5
K	10431 Reposa Cubiertos Cutlery Holder, Plateau À Couverts, Porta Posate, Schneidewagen	38,43 €	4-48 / 4	190	1,5
9773	24 Piezas 24 Pieces, Écrin 24 Pièces, Bauletto 24 Pz., 24 Stück	125,55 €	1-4 / 1		



ATLÁNTIDA



ATLÁNTIDA ICE BLACK

INOX 18/10 / 6mm / Ice Black



A B C D E F G H

REF.	Descripción	€	UE/MOQ	▶ mm	✂ mm
A 8579	Cuchillo Mesa Table Knife, Couteau Table, Coltello Tavola, Tafelmesser	9,25 €	6-60 / 6	226	
B 8580	Cuchara Mesa Table Spoon, Cuillère Table, Cucchiaio Tavola, Tafellöffel	9,71 €	6-60 / 6	215	6
C 8581	Tenedor Mesa Table Fork, Fourchette Table, Forchetta Tavola, Tafelgabel	9,81 €	6-60 / 6	218	6
D 8655	Cuchara Salsa Sauce Spoon, Cuillère A Sauce, Cucchiaio Salsa, Saucenlöffel	9,96 €	6-60 / 6	216	6
E 8582	Cuchillo Lunch Cake Knife, Couteau Gâteau, Coltello Dolce, Kuchenmesser	8,44 €	6-60 / 6	169	
F 8584	Cuchara Lunch Cake Spoon, Cuillère Gâteau, Cucchiaio Dolce, Lunch Löffel	7,79 €	6-60 / 6	163	5
G 8583	Tenedor Lunch Cake Fork, Fourchette Gâteau, Forchetta Dolce, Kuchengabel	5,84 €	6-60 / 6	160	5
H 8585	Cuchara Café Coffee/Moka Spoon, Cuillère Moka, Cucchiaio Moka, Mokkalöffel	5,61 €	6-60 / 6	109	3,5



9772 24 Piezas
24 Pieces, Écrin 24 Pièces, Bauletto 24 Pz., 24 Stück

ATLÁNTIDA POLVO DE LUNA

INOX 18/10 / 6mm / Shotblasting



A B C D E F G H I J

Everest + Atlántida



REF.	Descripción	€	UE/MOQ	▶ mm	✂ mm
A 10988	Cuchillo Chuletero Everest Steak Knife, Couteau Steak, Coltello Bistecca, Steakmesser	5,41 €	6-60 / 6	220	
B 10989	Tenedor Chuletero Everest Steak Knife, Couteau Steak, Coltello Bistecca, Steakmesser	4,82 €	6-60 / 6	206	6
C 10979	Cuchillo Mesa Table Knife, Couteau Table, Coltello Tavola, Tafelmesser	6,22 €	6-60 / 6	226	
D 10981	Cuchara Mesa Table Spoon, Cuillère Table, Cucchiaio Tavola, Tafellöffel	6,63 €	6-60 / 6	215	6
E 10980	Tenedor Mesa Table Fork, Fourchette Table, Forchetta Tavola, Tafelgabel	6,73 €	6-60 / 6	218	6
F 10986	Cuchara Salsa Sauce Spoon, Cuillère A Sauce, Cucchiaio Salsa, Saucenlöffel	7,05 €	6-60 / 6	216	6
G 10982	Cuchillo Lunch Cake Knife, Couteau Gâteau, Coltello Dolce, Kuchenmesser	5,60 €	6-60 / 6	169	
H 10984	Cuchara Lunch Cake Spoon, Cuillère Gâteau, Cucchiaio Dolce, Lunch Löffel	5,00 €	6-60 / 6	163	5
I 10983	Tenedor Lunch Cake Fork, Fourchette Gâteau, Forchetta Dolce, Kuchengabel	5,04 €	6-60 / 6	160	5
J 10985	Cuchara Café Coffee/Moka Spoon, Cuillère Moka, Cucchiaio Moka, Mokkalöffel	3,21 €	6-60 / 6	109	3,5



10987 24 Piezas
24 Pieces, Écrin 24 Pièces, Bauletto 24 Pz., 24 Stück



Comas presenta la colección de cubiertos LAB. Una colección diseñada para maximizar la experiencia de la degustación de aperitivos, tapas y arroces. Creada para complementar nuestra colección LAB ACCESSORIES, un conjunto de platillos u bases para servir en diferentes materiales y colores.

Todos los elementos de la colección siguen las mismas proporciones, ayudándote a crear múltiples composiciones, jugando con la modularidad y la combinación de colores, materiales y texturas.

Comas introduces its new LAB ACCESSORIES collection. A collection of dishes and serving platters in different materials and colours that goes perfectly with Culter's existing serving ware for you to make the experience of savouring canapés, tapas and rice dishes complete.

All the items in the collection are in the same proportions, so that you can create different compositions by exploiting their modularity and the combinations of colours, materials and textures.



Descubre más sobre los accesorios LAB.

LAB

INOX 18/10 / 2mm / Mirror

2020 WINNER
EUROPEAN
PRODUCT
DESIGN
AWARD



reddot design award
winner 2020



LAB
Collection.

LAB VINTAGE GOLD

INOX 18/10 / 2mm / Vintage Gold



REF.	Descripción	€	UE/MOQ	▶ mm	✂ mm
A 7890	Cuchillo Mesa Monobloc monoblock table knife, couteau table monobloc, coltello tavola monobloc, monoblock tafelmesser	2,44 €	12-120 / 12	160	
B 6976	Cuchillo Mesa table knife, couteau table, coltello tavola, tafelmesser	2,18 €	12-120 / 12	160	
C 6977	Tenedor Mesa table fork, fourchette table, forchetta tavola, tafelgabel	2,29 €	12-120 / 12	154	2
D 6978	Cuchara Mesa table spoon, cuillère table, cucchiaio tavola, tafellöffel	2,29 €	12-120 / 12	153	2
E 6979	Tenedor Arroz rice fork, fourchette à riz, forchetta riso, reispabel	2,14 €	12-120 / 12	148	2
F 6980	Pincho cocktail stick, stick à cocktail, spiedo, spie	1,99 €	12-120 / 12	100	2
G 6981	Pincho Largo large cocktail stick, stick à cocktail long, spiedo lungo, langer spie	2,03 €	12-120 / 12	135	2
H 6982	Tenedor Aperitivo appetizer fork, fourchette apéritif, forchetta antipasto, aperitif gabel	1,93 €	12-120 / 12	135	2
I 6983	Cuchara Aperitivo appetizer spoon, cuillère apéritif, cucchiaio antipasto, aperitif löffel	1,93 €	12-120 / 12	135	2
J 6984	Cuchara Moka coffee/moka spoon, cuillère moka, cucchiaio moka, mokkalöffel	1,88 €	12-120 / 12	101	1,5
K 6985	Cuchara Lunch cake spoon, cuillère gâteau, cucchiaio dolce, lunch löffel	2,02 €	12-120 / 12	125	2
L 6986	Tenedor Lunch cake fork, fourchette gâteau, forchetta dolce, kuchengabel	2,02 €	12-120 / 12	125	2
M 7891	Cuchillo Lunch Monobloc monoblock cake knife, couteau gâteau monobloc, coltello dolce monobloc, monobloc kuchenmesser	2,47 €	12-120 / 12	135	
N 6987	Cuchillo Lunch cake knife, couteau gâteau, coltello dolce, kuchenmesser	1,91 €	12-120 / 12	135	
O 6988	Cuchara Coctel Larga large cocktail, cuillère cocktail longue, cucchiaio cocktail lunga, cocktail löffel- lang	2,47 €	12-120 / 12	215	2
P 6989	Cuchara Café Espátula spatula coffee spoon, cuillère spatule, cucchiaio spatola, kaffeelöffel	1,91 €	12-120 / 12	108	2
Q 6995	Pinza Larga long tong, pince longue, molla lunga, lange zange	5,01 €	6-60 / 6	222	2
R 6996	Pinza Corta short tong, pince courte, molla corta, kurze zange	4,45 €	6-60 / 6	160	2
S 6997	Pinza Espátula spatula tong, pince spatule, molla spatola, kochzange	5,01 €	6-60 / 6	160	2
T 6998	Cuchara Degustación tasting spoon, cuillère dégustation, cucchiaio degustazione, probierlöffel	3,93 €	6-60 / 6	86	2
U 6999	Cuchara Degustación Oval oval tasting spoon, cuillère dégustation ovale, cucchiaio degustazione ovale, probierlöffel oval	4,21 €	6-60 / 6	101	2



REF.	Descripción	€	UE/MOQ	▶ mm	✂ mm
A 1539	Cuchillo Mesa Monobloc monoblock table knife, couteau table monobloc, coltello tavola monobloc, monoblock tafelmesser	4,18 €	12-120 / 12	160	
B 1541	Tenedor Mesa table fork, fourchette table, forchetta tavola, tafelgabel	3,99 €	12-120 / 12	154	2
C 1540	Cuchara Mesa table spoon, cuillère table, cucchiaio tavola, tafellöffel	3,99 €	12-120 / 12	153	2
D 1542	Tenedor Arroz rice fork, fourchette à riz, forchetta riso, reispabel	3,99 €	12-120 / 12	148	2
E 1543	Pincho cocktail stick, stick à cocktail, spiedo, spie	4,30 €	12-120 / 12	100	2
F 1544	Pincho Largo large cocktail stick, stick à cocktail long, spiedo lungo, langer spie	4,30 €	12-120 / 12	135	2
G 1545	Tenedor Aperitivo appetizer fork, fourchette apéritif, forchetta antipasto, aperitif gabel	3,75 €	12-120 / 12	135	2
H 1546	Cuchara Aperitivo appetizer spoon, cuillère apéritif, cucchiaio antipasto, aperitif löffel	3,75 €	12-120 / 12	135	2
I 1547	Cuchara Moka coffee/moka spoon, cuillère moka, cucchiaio moka, mokkalöffel	3,36 €	12-120 / 12	101	1,5
J 1549	Cuchara Lunch cake spoon, cuillère gâteau, cucchiaio dolce, lunch löffel	3,55 €	12-120 / 12	125	2
K 1550	Tenedor Lunch cake fork, fourchette gâteau, forchetta dolce, kuchengabel	4,04 €	12-120 / 12	125	2
L 1548	Cuchillo Lunch Monobloc monoblock cake knife, couteau gâteau monobloc, coltello dolce monobloc, monobloc kuchenmesser	4,01 €	12-120 / 12	135	
M 1551	Cuchara Coctel Larga large cocktail, cuillère cocktail longue, cucchiaio cocktail lunga, cocktail löffel- lang	4,09 €	12-120 / 12	215	2
N 1552	Cuchara Café Espátula spatula coffee spoon, cuillère spatule, cucchiaio spatola, mokkalöffel	3,65 €	12-120 / 12	108	2
O 1553	Cuchara Degustación tasting spoon, cuillère dégustation, cucchiaio degustazione, probierlöffel	7,05 €	6-60 / 6	86	2
P 1554	Cuchara Degustación Oval oval tasting spoon, cuillère dégustation ovale, cucchiaio degustazione ovale, probierlöffel oval	7,54 €	6-60 / 6	101	2



LAB VINTAGE COPPER

INOX 18/10 / 2mm / Vintage Copper



A B C D E F G H I J K L M N O P

LAB ICE BLACK

INOX 18/10 / 2mm / Ice Black



A B C D E F G H I J K L M N O P

REF.	Descripción	€	UE/MOQ	▶ mm	✂ mm
A 1555	Cuchillo Mesa Monobloc monoblock table knife, couteau table monobloc, coltello tavola monobloc, monoblock tafelmesser	4,43 €	12-120 / 12	160	
B 1557	Tenedor Mesa table fork, fourchette table, forchetta tavola, tafelgabel,	4,23 €	12-120 / 12	154	2
C 1556	Cuchara Mesa table spoon, cuillère table, cucchiaio tavola, tafellöffel	4,23 €	12-120 / 12	153	2
D 1558	Tenedor Arroz rice fork, fourchette à riz, forchetta riso, reisingabel	4,23 €	12-120 / 12	148	2
E 1559	Pincho cocktail stick, stick à cocktail, spiedo, spie	4,30 €	12-120 / 12	100	2
F 1560	Pincho Largo large cocktail stick, stick à cocktail long, spiedo lungo, langer spie	4,30 €	12-120 / 12	135	2
G 1561	Tenedor Aperitivo appetizer fork, fourchette apéritif, forchetta antipasto, aperitif gabel	3,99 €	12-120 / 12	135	2
H 1562	Cuchara Aperitivo appetizer spoon, cuillère apéritif, cucchiaio antipasto, aperitif löffel	3,99 €	12-120 / 12	135	2
I 1563	Cuchara Moka coffee/moka spoon, cuillère moka, cucchiaio moka, mokkalöffel	3,60 €	12-120 / 12	101	1,5
J 1565	Cuchara Lunch cake spoon, cuillère gâteau, cucchiaio dolce, lunch löffel	3,79 €	12-120 / 12	125	2
K 1566	Tenedor Lunch cake fork, fourchette gâteau, forchetta dolce, kuchengabel	4,28 €	12-120 / 12	125	2
L 1564	Cuchillo Lunch Monobloc monoblock cake knife, couteau gâteau monobloc, coltello dolce monobloc, monobloc kuchenmesser	4,29 €	12-120 / 12	135	
M 1567	Cuchara Coctel Larga large cocktail, cuillère cocktail longue, cucchiaio cocktail lunga, cocktail löffel- lang	4,33 €	12-120 / 12	215	2
N 1568	Cuchara Café Espátula spatula coffee spoon, cuillère spatule, cucchiaio spatola, mokkalöffel	3,89 €	12-120 / 12	108	2
O 1569	Cuchara Degustación tasting spoon, cuillère dégustation, cucchiaio degustazione, probierlöffel	7,30 €	6-60 / 6	86	2
P 1570	Cuchara Degustación Oval oval tasting spoon, cuillère dégustation ovale, cucchiaio degustazione ovale, probierlöffel oval	7,78 €	6-60 / 6	101	2



REF.	Descripción	€	UE/MOQ	▶ mm	✂ mm
A 8640	Cuchillo Mesa Monobloc monoblock table knife, couteau table monobloc, coltello tavola monobloc, monoblock tafelmesser	4,43 €	12-120 / 12	160	
B 7665	Tenedor Mesa table fork, fourchette table, forchetta tavola, tafelgabel,	4,23 €	12-120 / 12	154	2
C 8641	Cuchara Mesa table spoon, cuillère table, cucchiaio tavola, tafellöffel	4,23 €	12-120 / 12	153	2
D 8642	Tenedor Arroz rice fork, fourchette à riz, forchetta riso, reisingabel	4,23 €	12-120 / 12	148	2
E 8643	Pincho cocktail stick, stick à cocktail, spiedo, spie	4,30 €	12-120 / 12	100	2
F 8644	Pincho Largo large cocktail stick, stick à cocktail long, spiedo lungo, langer spie	4,30 €	12-120 / 12	135	2
G 8645	Tenedor Aperitivo appetizer fork, fourchette apéritif, forchetta antipasto, aperitif gabel	3,99 €	12-120 / 12	135	2
H 8646	Cuchara Aperitivo appetizer spoon, cuillère apéritif, cucchiaio antipasto, aperitif löffel	3,99 €	12-120 / 12	135	2
I 8647	Cuchara Moka coffee/moka spoon, cuillère moka, cucchiaio moka, mokkalöffel	3,60 €	12-120 / 12	101	1,5
J 8649	Cuchara Lunch cake spoon, cuillère gâteau, cucchiaio dolce, lunch löffel	3,79 €	12-120 / 12	125	2
K 8650	Tenedor Lunch cake fork, fourchette gâteau, forchetta dolce, kuchengabel	4,28 €	12-120 / 12	125	2
L 8648	Cuchillo Lunch Monobloc monoblock cake knife, couteau gâteau monobloc, coltello dolce monobloc, monobloc kuchenmesser	4,29 €	12-120 / 12	135	
M 8651	Cuchara Coctel Larga large cocktail, cuillère cocktail longue, cucchiaio cocktail lunga, cocktail löffel- lang	4,33 €	12-120 / 12	215	2
N 8652	Cuchara Café Espátula spatula coffee spoon, cuillère spatule, cucchiaio spatola, mokkalöffel	3,89 €	12-120 / 12	108	2
O 8653	Cuchara Degustación tasting spoon, cuillère dégustation, cucchiaio degustazione, probierlöffel	7,30 €	6-60 / 6	86	2
P 8654	Cuchara Degustación Oval oval tasting spoon, cuillère dégustation ovale, cucchiaio degustazione ovale, probierlöffel oval	7,78 €	6-60 / 6	101	2



Base porcelana pequeña

Small porcelain tray
Petit plateau en porcelaine
Vassoio piccolo porcellana
Porzellantablett klein

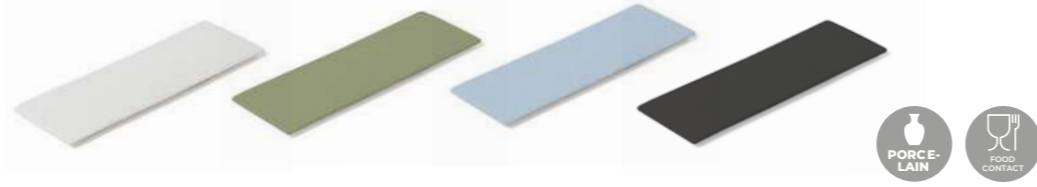

REF.	COLOR	W(mm)	L(mm)	€	UE / MOQ
8598	BLANCO	92,5	278	11,74	0-4-16 / 4
8600	VERDE	92,5	278	11,74	0-4-16 / 4
8602	AZUL	92,5	278	11,74	0-4-16 / 4
8596	NEGRO	92,5	278	11,74	0-4-16 / 4

Base porcelana grande

Double porcelain tray
Plateau en porcelaine double
Vassoio porcellana doppio
Doppeltes porzellantablett

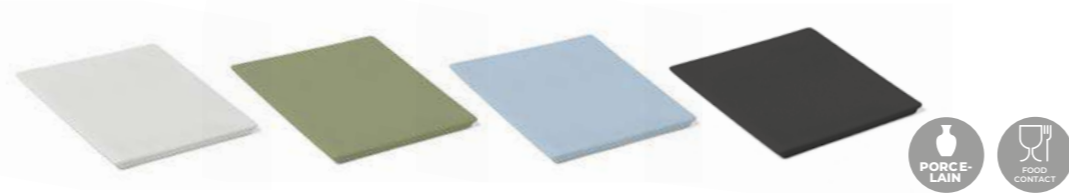

REF.	COLOR	W(mm)	L(mm)	€	UE / MOQ
8599	BLANCO	185	185	10,79	0-4-16 / 4
8601	VERDE	185	185	10,79	0-4-16 / 4
8603	AZUL	185	185	10,79	0-4-16 / 4
8597	NEGRO	185	185	10,79	0-4-16 / 4

Base madera

Wood tray
Plateau en bois
Vassoio legno
Holztablett



REF.	SIZE	W(mm)	L(mm)	€	UE / MOQ
8370	SIMPLE	92,5	278	6,60	0-4-16 / 4
8371	DOBLE	185	278	9,80	0-4-16 / 4

Disco pinchos

Round stick holder
Orte brochette rond
Disco fori spiedini
Runder edelstahl spießhalter



REF.	Ø(mm)	W(mm)	Para ref. / For ref.	€	UE / MOQ
8001	71	35	8000 - 8004	8,03	0-4-16 / 4

Plato gest M

Gest plate M
Plateau en porcelaine gest M
Vassoio porcellana gest M
Gest porzellantablett M



REF.	SIZE	H(mm)	W(mm)	L(mm)	€	UE / MOQ
9984	S	30	110	105	8,34	0-4-16 / 4
11808	M	30	145	200	13,04	0-4-48 / 4



LAB ACCESORIES

Plato 1/4 ración redondo

1/4 ration circle plate
plateau 1/4 bassin rond
vassoio 1/4 porzione rotonda
1/4 portion quadratischer edelstahl teller



REF.	W(mm)	L(mm)	€	UE / MOQ
8000	92,5	92,5	15,93	0-4-16 / 4

Plato 1 ración oval

1 ration oval plate
plateau 1 bassin ovale
vassoio 1 porzione ovale
1 portion rechteckiger edelstahl teller



REF.	W(mm)	L(mm)	€	UE / MOQ
8005	92,5	278	30,86	0-4-16 / 4

Plato 1/2 ración oval

1/2 ration oval plate
plateau 1/2 bassin ovale
vassoio 1/2 porzione ovale
ovale 1/2 portion rechteckiger edelstahl teller



REF.	W(mm)	L(mm)	€	UE / MOQ
8003	92,5	185	19,91	0-4-16 / 4

Plato 1/4 ración redondo doble

1/4 ration circle double plate
plateau 1/4 double bassin rond
vassoio 1/4 porzione doppia
1/4 portion rechteckiger edelstahl teller doppelt



REF.	W(mm)	L(mm)	€	UE / MOQ
8004	92,5	185	21,74	0-4-16 / 4

Plato 1 ración redondo

1 ration circle plate
plateau 1 bassin rond
vassoio 1 porzione rotonda
1 portion quadratischer edelstahl teller



REF.	W(mm)	L(mm)	€	UE / MOQ
8002	185	185	20,61	0-4-16 / 4

Plato 1/2 ración oval + pinchos

1/2 ration oval plate + stick holder
plateau 1/2 bassin ovale + porte brochette
vassoio 1/2 porzione ovale + fori spiedini
1/2 portion rechteckiger edelstahl teller mit spießhalter



REF.	W(mm)	L(mm)	€	UE / MOQ
8006	92,5	278	30,86	0-4-16 / 4



Plato 1 ración redondo PVD

PVD 1 ration circle plate
plateau bassin rond PVD
vassoio 1 porzione rotonda PVD
PVD 1 portion quadratischer edelstahl teller



ACABADO
ICE
ICE FINISH

REF.	COLOR	W(mm)	L(mm)	€	UE / MOQ
8604	ORO	185	185	24,73	0-4-16 / 4
8605	COBRE	185	185	24,73	0-4-16 / 4
8606	NEGRO	185	185	24,73	0-4-16 / 4



Plato 1/2 ración oval PVD

PVD 1/2 ration oval plate
plateau 1/2 bassin ovale PVD
vassoio 1/2 porzione ovale PVD
PVD ovale 1/2 portion rechteckiger edelstahl teller



ACABADO
ICE
ICE FINISH

REF.	COLOR	W(mm)	L(mm)	€	UE / MOQ
8607	ORO	92,5	185	22,74	0-4-16 / 4
8608	COBRE	92,5	185	22,74	0-4-16 / 4
8609	NEGRO	92,5	185	22,74	0-4-16 / 4



SAKURA



SAKURA
Collection.

SAKURA
INOX 18/10 / 5mm / Mirror



reddot design award
winner 2020



REF.	Descripción	€	UE/MOQ	▶ mm	✂ mm
A 6931	Cuchillo Mesa Table Knife, Couteau Table, Coltello Tavola, Tafelmesser	6,17 €	6-60 / 6	228	
B 6932	Cuchara Mesa Table Spoon, Cuillère Table, Cucchiao Tavola, Tafelöffel	6,42 €	6-60 / 6	206	5
C 6933	Tenedor Mesa Table Fork, Fourchette Table, Forchetta Tavola, Tafelgabel	6,42 €	6-60 / 6	210	5
D 6934	Cuchara Ramen Ramen Spoon, Cuillère Ramen, Cucchiao Ramen, Ramen Löffel	6,93 €	6-60 / 6	192	5
E 6935	Set Palillos Chopsticks Set, Set Piques, Set Bacchette, E_stäbchen- Set	3,74 €	6-60 / 6	230	5,5
F 7869	Soporte Cubiertos Cutlery Holder, Panier À Couverts, Supporto Coperte, Besteckhalter	11,78 €	6-60 / 6	80	8,5
G 6939	Tenedor Lunch Cake Fork, Fourchette Gâteau, Forchetta Dolce, Kuchengabel	3,59 €	6-60 / 6	151	3,5
H 6940	Cuchara Café Tea Spoon, Cuillère Café, Cucchiao Caffé, Kaffeeöffel	3,54 €	6-60 / 6	147	3
I 6941	Cuchara Moka Coffee/Moka Spoon, Cuillère Moka, Cucchiao Moka, Mokkalöffel	3,03 €	6-60 / 6	105	2
9789	24 Piezas 24 Pieces, Écrin 24 Pièces, Bauletto 24 Pz., 24 Stück	126,32 €	1-4 / 1		5





KODAI



**KODAI
Collection.**

2019 WINNER
EUROPEAN
PRODUCT
DESIGN
AWARD

KODAI VINTAGE

INOX Nickel Free 18% / 3mm / Vintage



REF.	Descripción	€	UE/MOQ	▶ mm	✂ mm
A 7276	Cuchillo Mesa XL Table Knife XI Vintage, Couteau Table XI Vintage, Coltello Tavola XI Vintage, Tafelmesser XI Vintage	3,89 €	12-120 / 12	212	
B 7279	Cuchara Mesa XL Table Spoon XI Vintage, Cuillère Table XI Vintage, Cucchiaino Tavola XI Vintage, Tafellöffel XI Vintage	2,90 €	12-120 / 12	190	3
C 7285	Tenedor Mesa 3 Puas XL Table Fork 3 Prongs XI Vintage, Fourchette Table XI 3 Dents Vintage, Forchetta Tavola XI 3 Punte Vintage, Tafelgabel XI Vintage	2,90 €	12-120 / 12	195	3
D 6943	Cuchillo Mesa Vintage Table Knife, Couteau Table Vintage, Coltello Tavola Vintage, Tafelmesser Vintage	3,70 €	12-120 / 12	183	
E 6944	Cuchara Mesa Vintage Table Spoon, Cuillère Table Vintage, Cucchiaino Tavola Vintage, Tafellöffel Vintage	2,63 €	12-120 / 12	170	2,5
F 6945	Tenedor Mesa 2 Puas Vintage Table Fork 2 Prongs, Fourchette Table 2 Dents Vintage, Forchetta Tavola 2 Punte, Tafelgabel 2	2,63 €	12-120 / 12	179	2,5
G 6946	Tenedor Mesa 3 Puas Vintage Table Fork 3 Prongs, Fourchette Table 3 Dents Vintage, Forchetta Tavola 3 Punte, Tafelgabel 3	2,63 €	12-120 / 12	163	2,5
H 6947	Cuchillo Mantequilla Vintage Butter Knife, Couteau Beurre, Coltello Burro, Buttermesser	3,46 €	12-120 / 12	155	
I 6948	Cuchillo Lunch Vintage Cake Knife, Couteau Gâteau, Coltello Dolce, Kuchenmesser	3,08 €	12-120 / 12	133	
J 6949	Tenedor Lunch Vintage Cake Fork, Fourchette Gâteau, Forchetta Dolce, Kuchengabel	2,09 €	12-120 / 12	138	2
K 6950	Cuchara Café Vintage Coffee Spoon, Cuillère Café, Cucchiaino Caffé, Kaffeelöffel	2,08 €	12-120 / 12	115,4	1,7
L 6951	Cuchara Side Vintage Side Spoon, Cuillère Side, Cucchiaino Side, Löffel Side	2,76 €	12-120 / 12	93,5	2
M 6952	Cuchara Moka Vintage Moka Spoon, Cuillère Moka, Cucchiaino Moka, Mokkalöffel	2,31 €	12-120 / 12	97,5	1,7
N 6953	Cuchara Arroz Vintage Rice Spoon, Cuillère À Riz, Cucchiaino Riso, Reislöffel	5,26 €	12-120 / 12	90	2,5
O 6954	Tenedor Rastrillo Vintage Wide Fork, Fourchette Râteau, Forchetta Wide, Tafelgabel Wide	4,75 €	12-120 / 12	113	2,5
9791	24 Piezas 24 Pieces, Écrin 24 Pièces, Bauletto 24 Pz., 24 Stück	76,20 €	1-4 / 1		3



KODAI VINTAGE GOLD

INOX Nickel Free 18% / 3mm / Vintage Gold

KODAI VINTAGE GOLD

INOX Nickel Free 18% / 3mm / Vintage Gold



REF.	Descripción	€	UE/MOQ	▶ mm	✂ mm
A 7278	Cuchillo Mesa XL Table Knife XI Vintage, Couteau Table XI Vintage, Coltello Tavola XI Vintage, Tafelmesser XI Vintage	6,23 €	12-120 / 12	212	
B 7281	Cuchara Mesa XL Table Spoon XI Vintage, Cuillère Table XI Vintage, Cucchiaio Tavola XI Vintage, Tafellöffel XI Vintage	5,19 €	12-120 / 12	190	3
C 7287	Tenedor Mesa 3 Puas XL Table Fork 3 Prongs XI Vintage, Fourchette Table XI 3 Dents Vintage, Forchetta Tavola XI 3 Punte Vintage, Tafelgabel XI Vintage	5,19 €	12-120 / 12	195	3
D 7081	Cuchillo Mesa Vintage Table Knife, Couteau Table Vintage, Coltello Tavola Vintage, Tafelmesser Vintage	5,48 €	12-120 / 12	183	
E 7082	Cuchara Mesa Vintage Table Spoon, Cuillère Table Vintage, Cucchiaio Tavola Vintage, Tafellöffel Vintage	4,46 €	12-120 / 12	170	2,5
F 7083	Tenedor Mesa 2 Puas Vintage Table Fork 2 Prongs, Fourchette Table 2 Dents Vintage, Forchetta Tavola 2 Punte, Tafelgabel 2	4,46 €	12-120 / 12	179	2,5
G 7084	Tenedor Mesa 3 Puas Vintage Table Fork 3 Prongs, Fourchette Table 3 Dents Vintage, Forchetta Tavola 3 Punte, Tafelgabel 3	4,46 €	12-120 / 12	163	2,5
H 7085	Cuchillo Mantequilla Vintage Butter Knife, Couteau Beurre, Coltello Burro, Buttermesser	5,17 €	12-120 / 12	155	
I 7086	Cuchillo Lunch Vintage Cake Knife, Couteau Gâteau, Coltello Dolce, Kuchenmesser	4,86 €	12-120 / 12	133	
J 7087	Tenedor Lunch Vintage Cake Fork, Fourchette Gâteau, Forchetta Dolce, Kuchengabel	3,85 €	12-120 / 12	138	2
K 7088	Cuchara Café Vintage Coffee Spoon, Cuillère Café, Cucchiaio Caffé, Kaffeelöffel	3,85 €	12-120 / 12	115,4	1,7
L 7089	Cuchara Side Vintage Side Spoon, Cuillère Side, Cucchiaio Side, Löffel Side	4,58 €	12-120 / 12	93,5	2
M 7090	Cuchara Moka Vintage Moka Spoon, Cuillère Moka, Cucchiaio Moka, Mokkalöffel	4,15 €	12-120 / 12	97,5	1,7
N 7091	Cuchara Arroz Vintage Rice Spoon, Cuillère À Riz, Cucchiaio Riso, Reislöffel	6,90 €	12-120 / 12	90	2,5
O 7092	Tenedor Rastrillo Vintage Wide Fork, Fourchette Râteau, Forchetta Wide, Tafelgabel Wide	6,90 €	12-120 / 12	113	2,5
9793	24 Piezas 24 Pieces, Écrin 24 Pièces, Bauletto 24 Pz., 24 Stück	110,00 €	1-4 / 1		3



KODAI VINTAGE COPPER

INOX Nickel Free 18% / 3mm / Vintage Copper



KODAI VINTAGE BLACK

INOX Nickel Free 18% / 3mm / Vintage Black

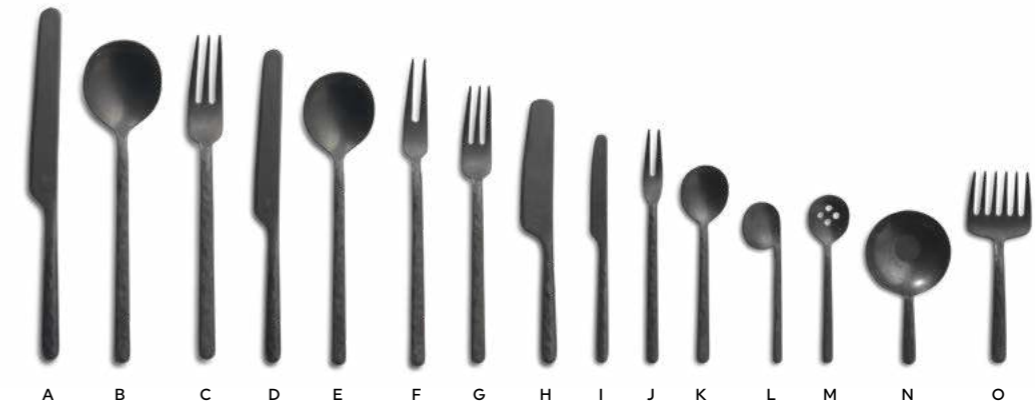

REF.	Descripción	€	UE/MOQ	▶ mm	✂ mm
A 4929	Cuchillo Mesa XL Table Knife XI Vintage, Couteau Table XI Vintage, Coltello Tavola XI Vintage, Tafelmesser XI Vintage	6,23 €	12-120 / 12	212	
B 4930	Cuchara Mesa XL Table Spoon XI Vintage, Cuillère Table XI Vintage, Cucchiaino Tavola XI Vintage, Tafellöffel XI Vintage	5,19 €	12-120 / 12	190	3
C 4931	Tenedor Mesa 3 Puas XL Table Fork 3 Prongs XI Vintage, Fourchette Table XI 3 Dents Vintage, Forchetta Tavola XI 3 Punte Vintage, Tafelgabel XI Vintage	5,19 €	12-120 / 12	195	3
D 4932	Cuchillo Mesa Vintage Table Knife, Couteau Table Vintage, Coltello Tavola Vintage, Tafelmesser Vintage	5,48 €	12-120 / 12	183	
E 4933	Cuchara Mesa Vintage Table Spoon, Cuillère Table Vintage, Cucchiaino Tavola Vintage, Tafellöffel Vintage	4,46 €	12-120 / 12	170	2,5
F 4934	Tenedor Mesa 2 Puas Vintage Table Fork 2 Prongs, Fourchette Table 2 Dents Vintage, Forchetta Tavola 2 Punte, Tafelgabel 2	4,46 €	12-120 / 12	179	2,5
G 4935	Tenedor Mesa 3 Puas Vintage Table Fork 3 Prongs, Fourchette Table 3 Dents Vintage, Forchetta Tavola 3 Punte, Tafelgabel 3	4,46 €	12-120 / 12	163	2,5
H 4936	Cuchillo Mantequilla Vintage Butter Knife, Couteau Beurre, Coltello Burro, Buttermesser	5,17 €	12-120 / 12	155	
I 4937	Cuchillo Lunch Vintage Cake Knife, Couteau Gâteau, Coltello Dolce, Kuchenmesser	4,86 €	12-120 / 12	133	
J 4938	Tenedor Lunch Vintage Cake Fork, Fourchette Gâteau, Forchetta Dolce, Kuchengabel	3,85 €	12-120 / 12	138	2
K 4939	Cuchara Café Vintage Coffee Spoon, Cuillère Café, Cucchiaino Caffé, Kaffeelöffel	3,85 €	12-120 / 12	115,4	1,7
L 4940	Cuchara Side Vintage Side Spoon, Cuillère Side, Cucchiaino Side, Löffel Side	4,58 €	12-120 / 12	93,5	2
M 4941	Cuchara Moka Vintage Moka Spoon, Cuillère Moka, Cucchiaino Moka, Mokkalöffel	4,15 €	12-120 / 12	97,5	1,7
N 4942	Cuchara Arroz Vintage Rice Spoon, Cuillère À Riz, Cucchiaino Riso, Reislöffel	6,90 €	12-120 / 12	90	2,5
O 4943	Tenedor Rastrillo Vintage Wide Fork, Fourchette Râteau, Forchetta Wide, Tafelgabel Wide	6,90 €	12-120 / 12	113	2,5
4945	24 Piezas 24 Pieces, Écrin 24 Pièces, Bauletto 24 Pz., 24 Stück	130,33 €	1-4 / 1		3



REF.	Descripción	€	UE/MOQ	▶ mm	✂ mm
A 7277	Cuchillo Mesa XL Table Knife XI Vintage, Couteau Table XI Vintage, Coltello Tavola XI Vintage, Tafelmesser XI Vintage	6,23 €	12-120 / 12	212	
B 7280	Cuchara Mesa XL Table Spoon XI Vintage, Cuillère Table XI Vintage, Cucchiaino Tavola XI Vintage, Tafellöffel XI Vintage	5,19 €	12-120 / 12	190	3
C 7286	Tenedor Mesa 3 Puas XL Table Fork 3 Prongs XI Vintage, Fourchette Table XI 3 Dents Vintage, Forchetta Tavola XI 3 Punte Vintage, Tafelgabel XI Vintage	5,19 €	12-120 / 12	195	3
D 7069	Cuchillo Mesa Vintage Table Knife, Couteau Table Vintage, Coltello Tavola Vintage, Tafelmesser Vintage	5,48 €	12-120 / 12	183	
E 7070	Cuchara Mesa Vintage Table Spoon, Cuillère Table Vintage, Cucchiaino Tavola Vintage, Tafellöffel Vintage	4,46 €	12-120 / 12	170	2,5
F 7071	Tenedor Mesa 2 Puas Vintage Table Fork 2 Prongs, Fourchette Table 2 Dents Vintage, Forchetta Tavola 2 Punte, Tafelgabel 2	4,46 €	12-120 / 12	179	2,5
G 7072	Tenedor Mesa 3 Puas Vintage Table Fork 3 Prongs, Fourchette Table 3 Dents Vintage, Forchetta Tavola 3 Punte, Tafelgabel 3	4,46 €	12-120 / 12	163	2,5
H 7073	Cuchillo Mantequilla Vintage Butter Knife, Couteau Beurre, Coltello Burro, Buttermesser	5,17 €	12-120 / 12	155	
I 7074	Cuchillo Lunch Vintage Cake Knife, Couteau Gâteau, Coltello Dolce, Kuchenmesser	4,86 €	12-120 / 12	133	
J 7075	Tenedor Lunch Vintage Cake Fork, Fourchette Gâteau, Forchetta Dolce, Kuchengabel	3,85 €	12-120 / 12	138	2
K 7076	Cuchara Café Vintage Coffee Spoon, Cuillère Café, Cucchiaino Caffé, Kaffeelöffel	3,85 €	12-120 / 12	115,4	1,7
L 7077	Cuchara Side Vintage Side Spoon, Cuillère Side, Cucchiaino Side, Löffel Side	4,58 €	12-120 / 12	93,5	2
M 7078	Cuchara Moka Vintage Moka Spoon, Cuillère Moka, Cucchiaino Moka, Mokkalöffel	4,15 €	12-120 / 12	97,5	1,7
N 7079	Cuchara Arroz Vintage Rice Spoon, Cuillère À Riz, Cucchiaino Riso, Reislöffel	6,90 €	12-120 / 12	90	2,5
O 7080	Tenedor Rastrillo Vintage Wide Fork, Fourchette Râteau, Forchetta Wide, Tafelgabel Wide	6,90 €	12-120 / 12	113	2,5
9795	24 Piezas 24 Pieces, Écrin 24 Pièces, Bauletto 24 Pz., 24 Stück	116,21 €	1-4 / 1		3



FLEUR DE LYS

INOX 18/10 / 4,5mm / Mirror



FLEUR DE LYS

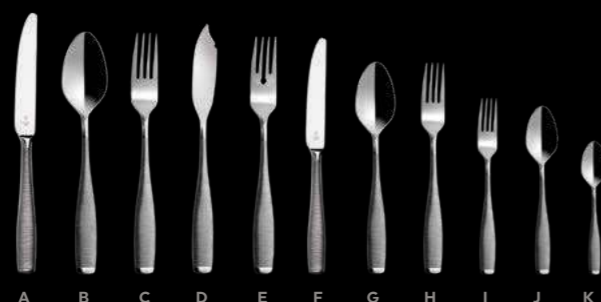

REF.	Descripción	€	UE/MOQ	▶ mm	✂ mm
A 7980	Cuchillo Mesa Table Knife, Couteau Table, Coltello Tavola, Tafelmesser	5,17 €	12-120 / 12	235	
B 7981	Cuchara Mesa Table Spoon, Cuillère Table, Cucchiaino Tavola, Tafellöffel	4,44 €	12-120 / 12	215	4,5
C 7982	Tenedor Mesa Table Fork, Fourchette Table, Forchetta Tavola, Tafelgabel	4,44 €	12-120 / 12	214	4,5
D 8007	Pala Pescado Fish Knife, Couteau Poisson, Coltello Pesce, Fischmesser	4,44 €	12-120 / 12	221	4,5
E 8008	Tenedor Pescado Fish Fork, Fourchette Poisson, Forchetta Pesce, Fischgabel	4,44 €	12-120 / 12	210	4,5
F 7983	Cuchillo Postre Dessert Knife, Couteau Dessert, Coltello Frutta, Dessertmesser	4,31 €	12-120 / 12	208	
G 7984	Cuchara Postre Dessert Spoon, Cuillère Dessert, Cucchiaino Frutta, Dessertlöffel	3,73 €	12-120 / 12	189	4
H 7985	Tenedor Postre Dessert Fork, Fourchette Dessert, Forchetta Frutta, Dessertgabel	3,73 €	12-120 / 12	186	4
I 7986	Tenedor Lunch Cake Fork, Fourchette Gâteau, Forchetta Dolce, Kuchengabel	2,47 €	12-120 / 12	156	3
J 7987	Cuchara Café Tea Spoon, Cuillère Café, Cucchiaino Caffé, Kaffeelöffel	2,47 €	12-120 / 12	150	3
K 7988	Cuchara Moka Coffee/Moka Spoon, Cuillère Moka, Cucchiaino Moka, Mokkalöffel	2,06 €	12-120 / 12	118	2,5
7989	24 Piezas 24 Pieces, Écrin 24 Pièces, Bauletto 24 Pz., 24 Stück	124,19 €	1-4 / 1		4,5





FLEUR DE LYS VINTAGE BLACK

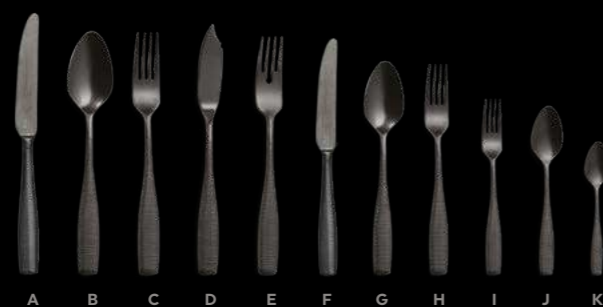

FLEUR DE LYS VINTAGE BLACK

INOX 18/10 / 4,5mm / Vintage Black



REF.	Descripción	€	UE/MOQ	▶ mm	✂ mm
A 6962	Cuchillo Mesa Table Knife, Couteau Table, Coltello Tavola, Tafelmesser	8,46 €	12-120 / 12	235	
B 6963	Cuchara Mesa Table Spoon, Cuillère Table, Cucchiaio Tavola, Tafellöffel	8,55 €	12-120 / 12	215	4,5
C 6964	Tenedor Mesa Table Fork, Fourchette Table, Forchetta Tavola, Tafelgabel	8,55 €	12-120 / 12	214	4,5
D 6965	Pala Pescado Fish Knife, Couteau Poisson, Coltello Pesce, Fischmesser	8,55 €	12-120 / 12	221	4,5
E 6966	Tenedor Pescado Fish Fork, Fourchette Poisson, Forchetta Pesce, Fischgabel	8,55 €	12-120 / 12	210	4,5
F 6967	Cuchillo Postre Dessert Knife, Couteau Dessert, Coltello Frutta, Dessertmesser	8,01 €	12-120 / 12	208	
G 6968	Cuchara Postre Dessert Spoon, Cuillère Dessert, Cucchiaio Frutta, Dessertlöffel	7,77 €	12-120 / 12	189	4
H 6969	Tenedor Postre Dessert Fork, Fourchette Dessert, Forchetta Frutta, Dessertgabel	7,77 €	12-120 / 12	186	4
I 6970	Tenedor Lunch Cake Fork, Fourchette Gâteau, Forchetta Dolce, Kuchengabel	6,22 €	12-120 / 12	156	3
J 6971	Cuchara Café Tea Spoon, Cuillère Café, Cucchiaio Caffé, Kaffeelöffel	6,22 €	12-120 / 12	150	3
K 6972	Cuchara Moka Coffee/Moka Spoon, Cuillère Moka, Cucchiaio Moka, Mokkalöffel	5,75 €	12-120 / 12	118	2,5
6973	24 Piezas 24 Pieces, Écrin 24 Pièces, Bauletto 24 Pz., 24 Stück	218,74 €	1-4 / 1		4,5





OSLO

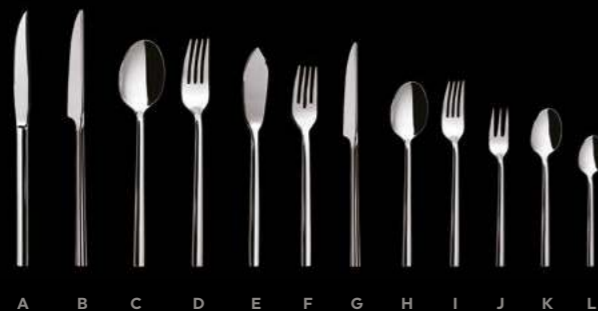

OSLO

INOX 18/10 / 7mm / Mirror / FORGED



REF.	Descripción	€	UE/MOQ	▶ mm	✂ mm
A 3619	Cuchillo Chuletero Steak Knife, Couteau Steak, Coltello Bistecca, Steakmesser	3,31 €	12-120 / 12	233	
B 5474	Cuchillo Mesa Table Knife, Couteau Table, Coltello Tavola, Tafelmesser	3,31 €	12-120 / 12	235	
C 5475	Cuchara Mesa Table Spoon, Cuillère Table, Cucchiao Tavola, Tafellöffel	5,41 €	12-120 / 12	208	7
D 5476	Tenedor Mesa Table Fork, Fourchette Table, Forchetta Tavola, Tafelgabel	5,41 €	12-120 / 12	208	7
E 5483	Pala Pescado Fish Knife, Couteau Poisson, Coltello Pesce, Fischmesser	4,55 €	12-120 / 12	200	6
F 5484	Tenedor Pescado Fish Fork, Fourchette Poisson, Forchetta Pesce, Fischgabel	4,55 €	12-120 / 12	185	6
G 2171	Cuchillo Postre Dessert Knife, Couteau Dessert, Coltello Frutta, Dessertmesser	3,03 €	12-120 / 12	205	
H 5485	Cuchara Postre Dessert Spoon, Cuillère Dessert, Cucchiao Frutta, Dessertlöffel	4,25 €	12-120 / 12	170	6
I 5486	Tenedor Postre Dessert Fork, Fourchette Dessert, Forchetta Frutta, Dessertgabel	4,25 €	12-120 / 12	170	6
J 5478	Tenedor Lunch Cake Fork, Fourchette Gâteau, Forchetta Dolce, Kuchengabel	3,69 €	12-120 / 12	148	5,5
K 5477	Cuchara Café Tea Spoon, Cuillère Café, Cucchiao Caffé, Kaffeelöffel	3,69 €	12-120 / 12	145	5,5
L 5479	Cuchara Moka Coffee/Moka Spoon, Cuillère Moka, Cucchiao Moka, Mokkalöffel	2,99 €	12-120 / 12	120	4,5
1600	24 Piezas 24 Pieces, Écrin 24 Pièces, Bauletto 24 Pz., 24 Stück	124,76 €	1-4 / 1		7



OSLO OCEAN FREE

INOX 18/10 / 4mm / Satin / Nylon



La colección OSLO OCEAN FREE ha sido producida con NYLON que provienen del plástico recuperado y reciclado. Este material, que constituye una parte significativa de los desechos plásticos en el océano, se recolecta, limpia y recicla mediante procesos avanzados para transformarlo en materias primas reutilizables.

Su fabricación supone una reducción de la huella de carbono y reduce el impacto sobre el medio ambiente frente a otros materiales.

The OSLO OCEAN FREE collection has been produced with NYLON from recovered and recycled plastic. This material, which constitutes a significant portion of the plastic waste in the ocean, is collected, cleaned, and recycled through advanced processes to transform it into reusable raw materials.

In addition, its manufacture reduces the carbon footprint and reduces the impact on the environment compared to other materials.

REF.	Descripción	€	UE/MOQ	▶ mm	✂ mm
A 12024	Cuchillo Mesa Table Knife, Couteau Table, Coltello Tavola, Tafelmesser	10,67 €	12-120 / 12	226	
B 12025	Cuchara Mesa Table Spoon, Cuillère Table, Cucchiaio Tavola, Tafellöffel	10,05 €	12-120 / 12	210	4
C 12026	Tenedor Mesa Table Fork, Fourchette Table, Forchetta Tavola, Tafelgabel	10,05 €	12-120 / 12	210	4
D 12027	Cuchara Café Tea Spoon, Cuillère Café, Cucchiaio Caffé, Kaffeelöffel	7,69 €	12-120 / 12	150	3,5
12028	24 Piezas 24 Pieces, Écrin 24 Pièces, Bauletto 24 Pz., 24 Stück	234,30 €	1-4 / 1		4



IRIS

INOX 18/10 / 6mm / Mirror

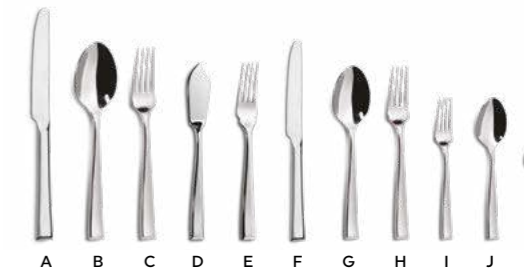

REF.	Descripción	€	UE/MOQ	▶ mm	✂ mm
A 7022	Cuchillo Mesa Table Knife, Couteau Table, Coltello Tavola, Tafelmesser	4,80 €	12-120 / 12	243	8
B 7023	Cuchara Mesa Table Spoon, Cuillère Table, Cucchiaio Tavola, Tafellöffel	4,55 €	12-120 / 12	209	6
C 7024	Tenedor Mesa Table Fork, Fourchette Table, Forchetta Tavola, Tafelgabel	4,55 €	12-120 / 12	209	6
D 7025	Pala Pescado Fish Knife, Couteau Poisson, Coltello Pesce, Fischmesser	4,46 €	12-120 / 12	188	5
E 7026	Tenedor Pescado Fish Fork, Fourchette Poisson, Forchetta Pesce, Fischgabel	4,41 €	12-120 / 12	188	5
F 7027	Cuchillo Postre Dessert Knife, Couteau Dessert, Coltello Frutta, Dessertmesser	4,15 €	12-120 / 12	210	7
G 7028	Cuchara Postre Dessert Spoon, Cuillère Dessert, Cucchiaio Frutta, Dessertlöffel	4,41 €	12-120 / 12	184	5
H 7029	Tenedor Postre Dessert Fork, Fourchette Dessert, Forchetta Frutta, Dessertgabel	4,41 €	12-120 / 12	184	5
I 7030	Tenedor Lunch Cake Fork, Fourchette Gâteau, Forchetta Dolce, Kuchengabel	2,89 €	12-120 / 12	151	4,5
J 7031	Cuchara Café Tea Spoon, Cuillère Café, Cucchiaio Caffé, Kaffeelöffel	2,89 €	12-120 / 12	151	4,5
K 7032	Cuchara Moka Coffee/Moka Spoon, Cuillère Moka, Cucchiaio Moka, Mokkalöffel	2,60 €	12-120 / 12	108	4
5965	24 Piezas 24 Pieces, Écrin 24 Pièces, Bauletto 24 Pz., 24 Stück	109,82 €	1-4 / 1		6





DALIA

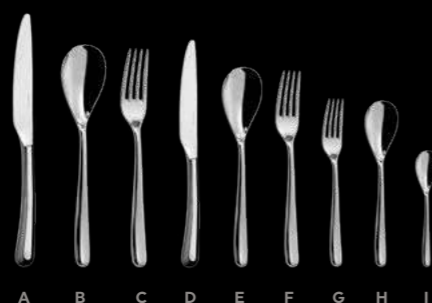

REF.	Descripción	€	UE/MOQ	▶ mm	✂ mm
A 7057	Cuchillo Mesa Table Knife, Couteau Table, Coltello Tavola, Tafelmesser	6,18 €	12-120 / 12	234	
B 7058	Cuchara Mesa Table Spoon, Cuillère Table, Cucchiaino Tavola, Tafellöffel	6,46 €	12-120 / 12	205	8,5
C 7059	Tenedor Mesa Table Fork, Fourchette Table, Forchetta Tavola, Tafelgabel	6,46 €	12-120 / 12	204	8,5
D 7060	Cuchillo Postre Dessert Knife, Couteau Dessert, Coltello Frutta, Dessertmesser	6,07 €	12-120 / 12	210	
E 7061	Cuchara Postre Dessert Spoon, Cuillère Dessert, Cucchiaino Frutta, Dessertlöffel	6,23 €	12-120 / 12	182	7,5
F 7062	Tenedor Postre Dessert Fork, Fourchette Dessert, Forchetta Frutta, Dessertgabel	6,28 €	12-120 / 12	181	7,5
G 7063	Tenedor Lunch Cake Fork, Fourchette Gâteau, Forchetta Dolce, Kuchengabel	4,37 €	12-120 / 12	156	6,4
H 7064	Cuchara Café/Te Coffee/Iced Tea Spoon, Cuillère Café/Té, Cucchiaino Caffé/The, Cocktaillöffel	4,37 €	12-120 / 12	154	6,4
I 7065	Cuchara Moka Coffee/Moka Spoon, Cuillère Moka, Cucchiaino Moka, Mokkalöffel	4,22 €	12-120 / 12	108	4,5
5963	24 Piezas 24 Pieces, Écrin 24 Pièces, Bauletto 24 Pz., 24 Stück	164,15 €	1-4 / 1		8,5



CONTOUR

INOX 18/10 / 4mm / Mirror



REF.	Descripción	€	UE/MOQ	▶ mm	✂ mm
A 7968	Cuchillo Mesa Table Knife, Couteau Table, Coltello Tavola, Tafelmesser	4,47 €	12-120 / 12	238	
B 7969	Cuchara Mesa Table Spoon, Cuillère Table, Cucchiaino Tavola, Tafellöffel	4,18 €	12-120 / 12	213	4
C 7970	Tenedor Mesa Table Fork, Fourchette Table, Forchetta Tavola, Tafelgabel	4,18 €	12-120 / 12	213	4
D 7971	Pala Pescado Fish Knife, Couteau Poisson, Coltello Pesce, Fischmesser	4,24 €	12-120 / 12	224	4
E 7972	Tenedor Pescado Fish Fork, Fourchette Poisson, Forchetta Pesce, Fischgabel	4,24 €	12-120 / 12	200	4
F 7973	Cuchillo Postre Dessert Knife, Couteau Dessert, Coltello Frutta, Dessertmesser	3,68 €	12-120 / 12	216	
G 7974	Cuchara Postre Dessert Spoon, Cuillère Dessert, Cucchiaino Frutta, Dessertlöffel	3,40 €	12-120 / 12	192	3,5
H 7975	Tenedor Postre Dessert Fork, Fourchette Dessert, Forchetta Frutta, Dessertgabel	3,40 €	12-120 / 12	192	3,5
I 7976	Tenedor Lunch Cake Fork, Fourchette Gâteau, Forchetta Dolce, Kuchengabel	2,03 €	12-120 / 12	140	3
J 7977	Cuchara Café Tea Spoon, Cuillère Café, Cucchiaino Caffé, Kaffeelöffel	2,03 €	12-120 / 12	140	3
K 7978	Cuchara Moka Coffee/Moka Spoon, Cuillère Moka, Cucchiaino Moka, Mokkalöffel	1,69 €	12-120 / 12	115	2,5
7979	24 Piezas 24 Pieces, Écrin 24 Pièces, Bauletto 24 Pz., 24 Stück	98,05 €	1-4 / 1		4

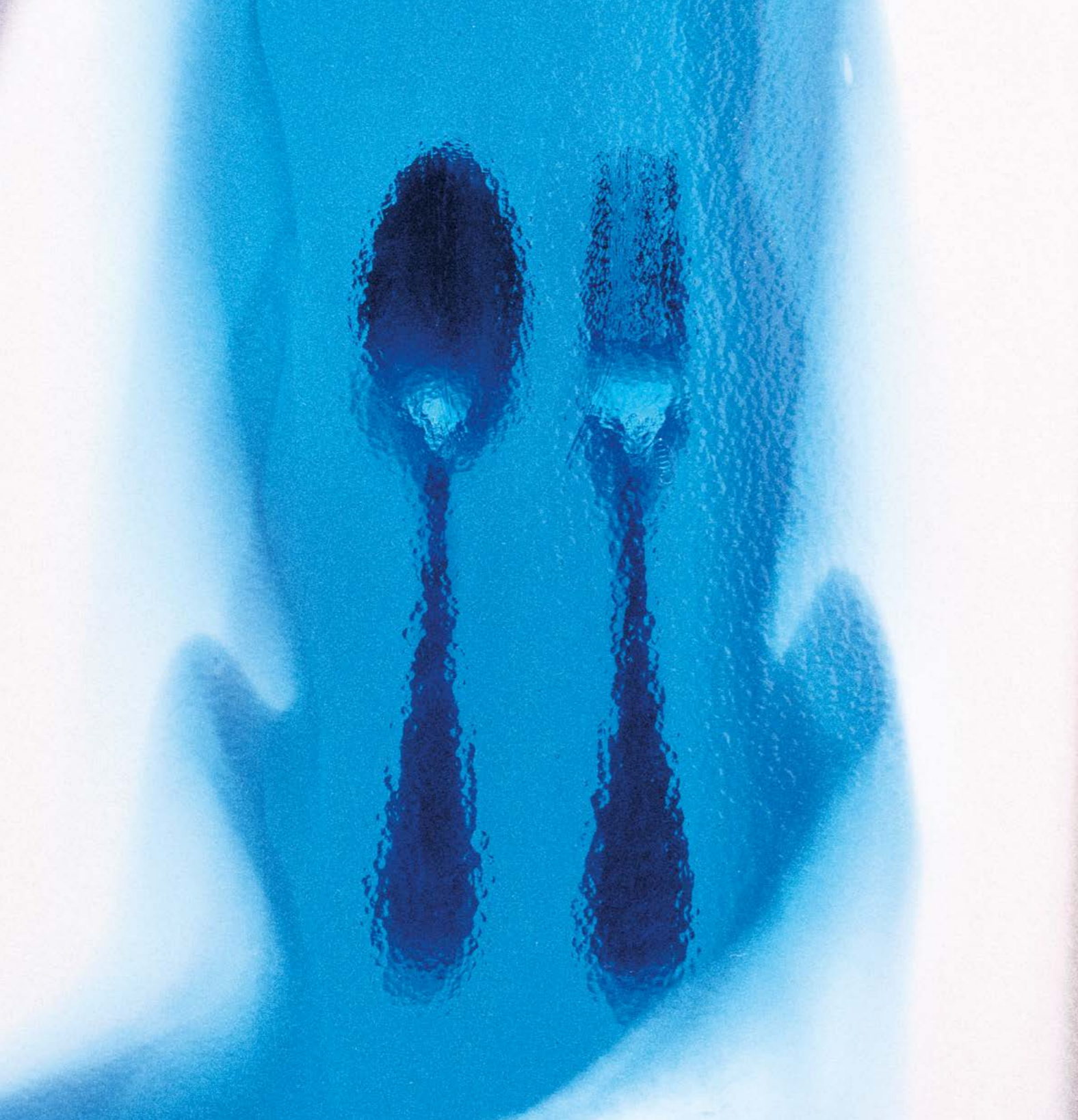

CONTOUR

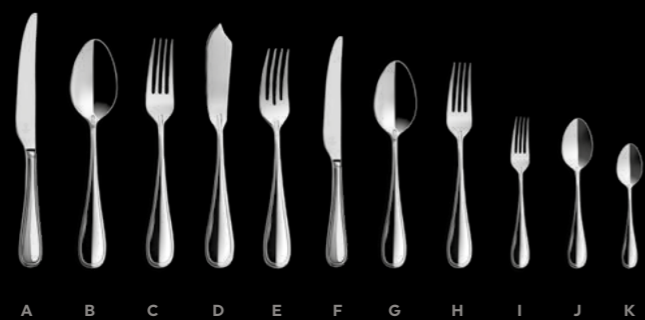

CONTOUR VINTAGE GOLD

INOX 18/10 / 4mm / Vintage

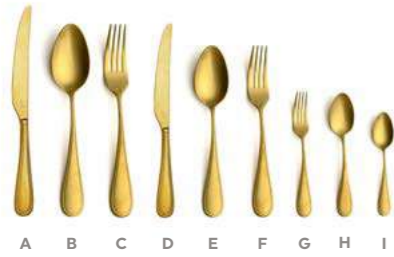

35 años creando valor juntos

Desde hace 35 años creando, inspirando, diseñando, comercializando, produciendo y transformando la cubertería junto a los diversos profesionales de la industria.

35 years creating value together

For 35 years, we have been creating, inspiring, designing, marketing, producing and transforming cutlery together with various professionals in the industry.



REF.	Descripción	€	UE/MOQ	▶ mm	✂ mm
A 5783	Cuchillo Mesa Table Knife, Couteau Table, Coltello Tavola, Tafelmesser	6,53 €	12-120 / 12	238	
B 5784	Cuchara Mesa Table Spoon, Cuillère Table, Cucchiaino Tavola, Tafellöffel	7,15 €	12-120 / 12	213	4
C 5785	Tenedor Mesa Table Fork, Fourchette Table, Forchetta Tavola, Tafelgabel	7,15 €	12-120 / 12	213	4
D 5786	Cuchillo Postre Dessert Knife, Couteau Dessert, Coltello Frutta, Dessertmesser	5,81 €	12-120 / 12	216	
E 5787	Cuchara Postre Dessert Spoon, Cuillère Dessert, Cucchiaino Frutta, Dessertlöffel	6,12 €	12-120 / 12	192	3,5
F 5788	Tenedor Postre Dessert Fork, Fourchette Dessert, Forchetta Frutta, Dessertgabel	6,12 €	12-120 / 12	192	3,5
G 5789	Tenedor Lunch Cake Fork, Fourchette Gâteau, Forchetta Dolce, Kuchengabel	4,67 €	12-120 / 12	140	3
H 5790	Cuchara Café Tea Spoon, Cuillère Café, Cucchiaino Caffé, Kaffeelöffel	4,67 €	12-120 / 12	140	3
I 5791	Cuchara Moka Coffee/Moka Spoon, Cuillère Moka, Cucchiaino Moka, Mokkalöffel	4,22 €	12-120 / 12	115	2,5
5792	24 Piezas 24 Pièces, Ecrin 24 Pièces, Bauletto 24 Pz., 24 Stück	157,22 €	1-4 / 1		4



SANGIOVESE

INOX 18/10 / 3,5mm / Mirror

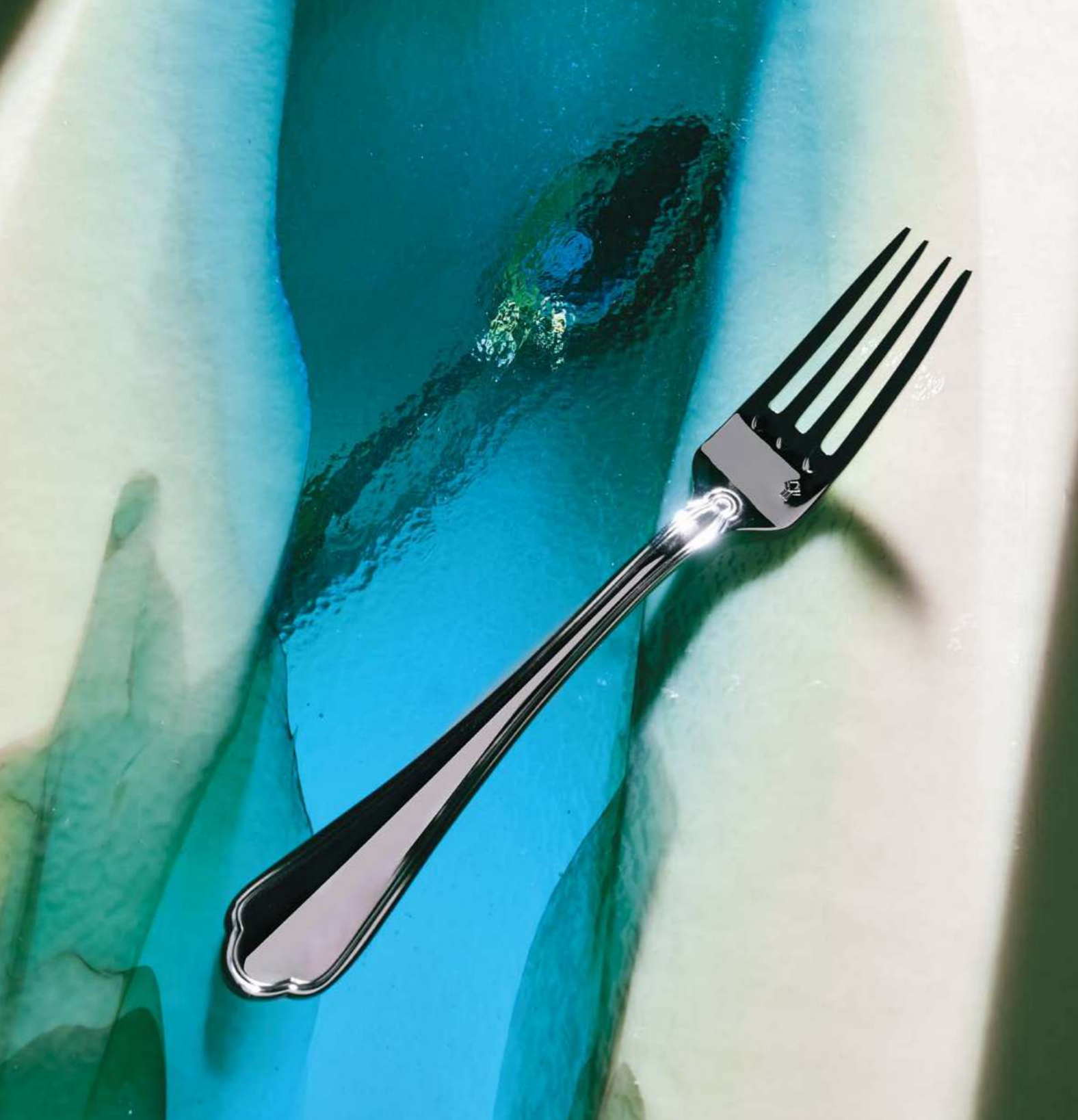

SANGIOVESE



REF.	Descripción	€	UE/MOQ	▶ mm	✂ mm
A 6895	Cuchillo Mesa Table Knife, Couteau Table, Coltello Tavola, Tafelmesser	5,16 €	12-120 / 12	255	
B 6896	Cuchara Mesa Table Spoon, Cuillère Table, Cucchiaio Tavola, Tafellöffel	3,87 €	12-120 / 12	209	3,5
C 6897	Tenedor Mesa Table Fork, Fourchette Table, Forchetta Tavola, Tafelgabel	3,87 €	12-120 / 12	209	3,5
D 6898	Pala Pescado Fish Knife, Couteau Poisson, Coltello Pesce, Fischmesser	3,17 €	12-120 / 12	208	3
E 6899	Tenedor Pescado Fish Fork, Fourchette Poisson, Forchetta Pesce, Fischgabel	2,96 €	12-120 / 12	190	3
F 6900	Cuchillo Postre Dessert Knife, Couteau Dessert, Coltello Frutta, Dessertmesser	3,83 €	12-120 / 12	232	
G 6901	Cuchara Postre Dessert Spoon, Cuillère Dessert, Cucchiaio Frutta, Dessertlöffel	2,96 €	12-120 / 12	190	3
H 6902	Tenedor Postre Dessert Fork, Fourchette Dessert, Forchetta Frutta, Dessertgabel	2,96 €	12-120 / 12	190	3
I 6903	Tenedor Lunch Cake Fork, Fourchette Gâteau, Forchetta Dolce, Kuchengabel	2,39 €	12-120 / 12	170	3
J 6904	Cuchara Café Tea Spoon, Cuillère Café, Cucchiaio Caffé, Kaffeelöffel	2,16 €	12-120 / 12	142	3
K 6905	Cuchara Moka Coffee/Moka Spoon, Cuillère Moka, Cucchiaio Moka, Mokkalöffel	1,45 €	12-120 / 12	111	2
6906	24 Piezas 24 Pieces, Ecrin 24 Pièces, Bauletto 24 Pz., 24 Stück	87,79 €	1-4 / 1		3,5



SANGIOVESE GOLD

INOX 18/10 / 3,5mm / Mirror

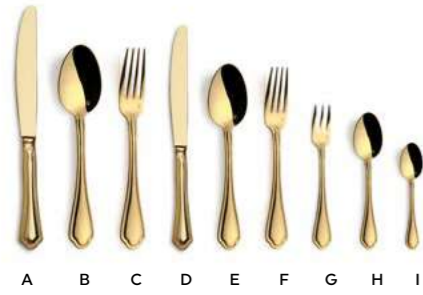

REF.	Descripción	€	UE/MOQ	▶ mm	✂ mm
A 7271	Cuchillo Mesa Table Knife, Couteau Table, Coltello Tavola, Tafelmesser	7,90 €	12-120 / 12	255	
B 7418	Cuchara Mesa Table Spoon, Cuillère Table, Cucchiaio Tavola, Tafellöffel	6,14 €	12-120 / 12	209	3,5
C 7272	Tenedor Mesa Table Fork, Fourchette Table, Forchetta Tavola, Tafelgabel	6,14 €	12-120 / 12	209	3,5
D 7420	Cuchillo Postre Dessert Knife, Couteau Dessert, Coltello Frutta, Dessertmesser	6,23 €	12-120 / 12	232	
E 7419	Cuchara Postre Dessert Spoon, Cuillère Dessert, Cucchiaio Frutta, Dessertlöffel	5,03 €	12-120 / 12	190	3
F 7273	Tenedor Postre Dessert Fork, Fourchette Dessert, Forchetta Frutta, Dessertgabel	5,03 €	12-120 / 12	190	3
G 7957	Tenedor Lunch Cake Fork, Fourchette Gâteau, Forchetta Dolce, Kuchengabel	4,34 €	12-120 / 12	170	3
H 7274	Cuchara Café Tea Spoon, Cuillère Café, Cucchiaio Caffé, Kaffeelöffel	4,05 €	12-120 / 12	142	3
I 7275	Cuchara Moka Coffee/Moka Spoon, Cuillère Moka, Cucchiaio Moka, Mokkalöffel	3,19 €	12-120 / 12	111	2

5554 24 Piezas
24 Pieces, Écrin 24 Pièces, Bauletto 24 Pz., 24 Stück

CALLAS

INOX 18/10 / 3,5mm / Mirror

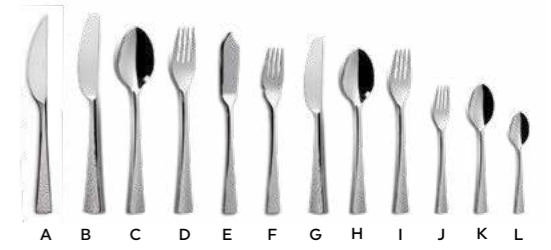

REF.	Descripción	€	UE/MOQ	▶ mm	✂ mm
A 7010	Cuchillo Chuletero Steak Knife, Couteau Steak, Coltello Bistecca, Steakmesser	4,78 €	12-120 / 12	225	
B 7011	Cuchillo Mesa Table Knife, Couteau Table, Coltello Tavola, Tafelmesser	4,60 €	12-120 / 12	225	7
C 7012	Cuchara Mesa Table Spoon, Cuillère Table, Cucchiaio Tavola, Tafellöffel	3,64 €	12-120 / 12	215	3,5
D 7013	Tenedor Mesa Table Fork, Fourchette Table, Forchetta Tavola, Tafelgabel	3,64 €	12-120 / 12	212	3,5
E 7014	Pala Pescado Fish Knife, Couteau Poisson, Coltello Pesce, Fischmesser	3,32 €	12-120 / 12	205	3
F 7015	Tenedor Pescado Fish Fork, Fourchette Poisson, Forchetta Pesce, Fischgabel	3,32 €	12-120 / 12	188	3
G 7016	Cuchillo Postre Dessert Knife, Couteau Dessert, Coltello Frutta, Dessertmesser	4,05 €	12-120 / 12	203	6
H 7017	Cuchara Postre Dessert Spoon, Cuillère Dessert, Cucchiaio Frutta, Dessertlöffel	2,89 €	12-120 / 12	185	3
I 7018	Tenedor Postre Dessert Fork, Fourchette Dessert, Forchetta Frutta, Dessertgabel	2,89 €	12-120 / 12	185	3
J 7019	Tenedor Lunch Cake Fork, Fourchette Gâteau, Forchetta Dolce, Kuchengabel	2,31 €	12-120 / 12	145	2,5
K 7020	Cuchara Café Tea Spoon, Cuillère Café, Cucchiaio Caffé, Kaffeelöffel	2,31 €	12-120 / 12	147	2,5
L 7021	Cuchara Moka Coffee/Moka Spoon, Cuillère Moka, Cucchiaio Moka, Mokkalöffel	2,15 €	12-120 / 12	115	2

5964 24 Piezas
24 Pieces, Écrin 24 Pièces, Bauletto 24 Pz., 24 Stück



VERSAILLES

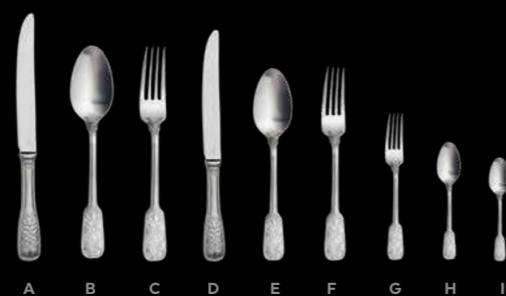

VERSAILLES SATIN

INOX 18/10 / 3,5mm / Satin



REF.	Descripción	€	UE/MOQ	▶ mm	✂ mm
A 7765	Cuchillo Mesa Table Knife, Couteau Table, Coltello Tavola, Tafelmesser	4,74 €	12-120 / 12	245	
B 7766	Cuchara Mesa Table Spoon, Cuillère Table, Cucchiaio Tavola, Tafellöffel	4,69 €	12-120 / 12	210	3,5
C 7767	Tenedor Mesa Table Fork, Fourchette Table, Forchetta Tavola, Tafelgabel	4,69 €	12-120 / 12	210	3,5
D 7770	Cuchillo Postre Dessert Knife, Couteau Dessert, Coltello Frutta, Dessertmesser	3,80 €	12-120 / 12	220	
E 7771	Cuchara Postre Dessert Spoon, Cuillère Dessert, Cucchiaio Frutta, Dessertlöffel	3,60 €	12-120 / 12	190	3
F 7772	Tenedor Postre Dessert Fork, Fourchette Dessert, Forchetta Frutta, Dessertgabel	3,60 €	12-120 / 12	190	3
G 7773	Tenedor Lunch Cake Fork, Fourchette Gâteau, Forchetta Dolce, Kuchengabel	2,40 €	12-120 / 12	140	2,5
H 7774	Cuchara Café Tea Spoon, Cuillère Café, Cucchiaio Caffé, Kaffeelöffel	2,40 €	12-120 / 12	140	2,5
I 7775	Cuchara Moka Coffee/Moka Spoon, Cuillère Moka, Cucchiaio Moka, Mokkalöffel	1,99 €	12-120 / 12	115	1,8
7776	24 Piezas 24 Pieces, Écrin 24 Pièces, Bauletto 24 Pz, 24 Stück	110,85 €	1-4 / 1		3,5



VERSAILLES SATIN COPPER

INOX 18/10 / 3,5mm / Satin



REF.	Descripción	€	UE/MOQ	▶ mm	✂ mm
A 5754	Cuchillo Mesa Table Knife, Couteau Table, Coltello Tavola, Tafelmesser	7,44 €	12-120 / 12	245	
B 5755	Cuchara Mesa Table Spoon, Cuillère Table, Cucchiaio Tavola, Tafellöffel	7,44 €	12-120 / 12	210	3,5
C 5756	Tenedor Mesa Table Fork, Fourchette Table, Forchetta Tavola, Tafelgabel	7,44 €	12-120 / 12	210	3,5
D 5757	Cuchillo Postre Dessert Knife, Couteau Dessert, Coltello Frutta, Dessertmesser	6,46 €	12-120 / 12	220	
E 5758	Cuchara Postre Dessert Spoon, Cuillère Dessert, Cucchiaio Frutta, Dessertlöffel	6,23 €	12-120 / 12	190	3
F 5759	Tenedor Postre Dessert Fork, Fourchette Dessert, Forchetta Frutta, Dessertgabel	6,23 €	12-120 / 12	190	3
G 5760	Tenedor Lunch Cake Fork, Fourchette Gâteau, Forchetta Dolce, Kuchengabel	4,91 €	12-120 / 12	140	2,5
H 5761	Cuchara Café Tea Spoon, Cuillère Café, Cucchiaio Caffé, Kaffeelöffel	4,91 €	12-120 / 12	140	2,5
I 5762	Cuchara Moka Coffee/Moka Spoon, Cuillère Moka, Cucchiaio Moka, Mokkalöffel	4,45 €	12-120 / 12	115	1,8
8806	24 Piezas 24 Pieces, Écrin 24 Pièces, Bauletto 24 Pz., 24 Stück	165,38 €	1-4 / 1		3,5



TULIP

INOX 18/10 / 4mm / Mirror

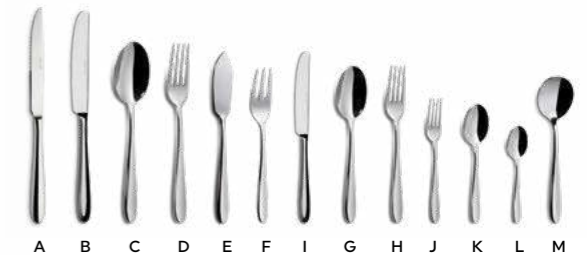

REF.	Descripción	€	UE/MOQ	▶ mm	✂ mm
A 7033	Cuchillo Chuletero Steak Knife, Couteau Steak, Coltello Bistecca, Steakmesser	4,64 €	12-120 / 12	244	
B 7034	Cuchillo Mesa Table Knife, Couteau Table, Coltello Tavola, Tafelmesser	4,64 €	12-120 / 12	237	
C 7035	Cuchara Mesa Table Spoon, Cuillère Table, Cucchiaio Tavola, Tafellöffel	3,54 €	12-120 / 12	207	4
D 7036	Tenedor Mesa Table Fork, Fourchette Table, Forchetta Tavola, Tafelgabel	3,54 €	12-120 / 12	206	4
E 7037	Pala Pescado Fish Knife, Couteau Poisson, Coltello Pesce, Fischmesser	2,95 €	12-120 / 12	195	3,5
F 7038	Tenedor Pescado Fish Fork, Fourchette Poisson, Forchetta Pesce, Fischgabel	2,95 €	12-120 / 12	176	3,5
G 7039	Cuchillo Postre Dessert Knife, Couteau Dessert, Coltello Frutta, Dessertmesser	3,90 €	12-120 / 12	195	
H 7040	Cuchara Postre Dessert Spoon, Cuillère Dessert, Cucchiaio Frutta, Dessertlöffel	2,77 €	12-120 / 12	178	3,5
I 7041	Tenedor Postre Dessert Fork, Fourchette Dessert, Forchetta Frutta, Dessertgabel	2,77 €	12-120 / 12	179	3,5
J 7042	Tenedor Lunch Cake Fork, Fourchette Gâteau, Forchetta Dolce, Kuchengabel	1,82 €	12-120 / 12	142	3
K 7043	Cuchara Café Tea Spoon, Cuillère Café, Cucchiaio Caffé, Kaffeelöffel	1,82 €	12-120 / 12	135	3
L 7044	Cuchara Moka Coffee/Moka Spoon, Cuillère Moka, Cucchiaio Moka, Mokkalöffel	1,57 €	12-120 / 12	111	2,5
M 7045	Cuchara Consomé Consommé Spoon, Cuillère Consommé, Cucchiaio Zuppa, Bouillonlöffel	2,62 €	12-120 / 12	166	3,5
5961	24 Piezas 24 Pieces, Écrin 24 Pièces, Bauletto 24 Pz., 24 Stück	103,35 €	1-4 / 1		4



MARANTA

INOX 18/10 / 4mm / Mirror



MARANTA

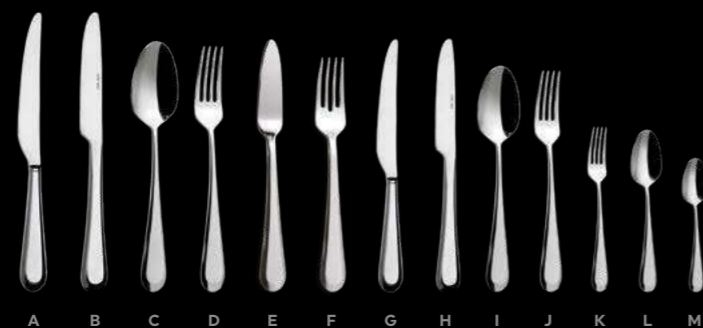

REF.	Descripción	€	UE/MOQ	▶ mm	✂ mm
A 7288	Cuchillo Mesa Clasico Classic Table Knife, Couteau Table Classic, Coltello Tavola Classic, Tafelmesser Classic	4,20 €	12-120 / 12	238	
B 6485	Cuchillo Mesa Table Knife, Couteau Table, Coltello Tavola, Tafelmesser	3,76 €	12-120 / 12	238	
C 6486	Cuchara Mesa Table Spoon, Cuillère Table, Cucchiaio Tavola, Tafellöffel	3,57 €	12-120 / 12	212	4
D 6487	Tenedor Mesa Table Fork, Fourchette Table, Forchetta Tavola, Tafelgabel	3,57 €	12-120 / 12	212	4
E 6488	Pala Pescado Fish Knife, Couteau Poisson, Coltello Pesce, Fischmesser	3,57 €	12-120 / 12	215	4
F 6489	Tenedor Pescado Fish Fork, Fourchette Poisson, Forchetta Pesce, Fischgabel	3,57 €	12-120 / 12	200	4
G 6691	Cuchillo Postre Clasico Classic Dessert Knife, Couteau Dessert Classic, Coltello Frutta Classic, Dessertmesser Classic	3,46 €	12-120 / 12	214	
H 6490	Cuchillo Postre Dessert Knife, Couteau Dessert, Coltello Frutta, Dessertmesser	3,41 €	12-120 / 12	214	
I 6491	Cuchara Postre Dessert Spoon, Cuillère Dessert, Cucchiaio Frutta, Dessertlöffel	2,97 €	12-120 / 12	191	3,5
J 6492	Tenedor Postre Dessert Fork, Fourchette Dessert, Forchetta Frutta, Dessertgabel	2,97 €	12-120 / 12	191	3,5
K 6493	Tenedor Lunch Cake Fork, Fourchette Gâteau, Forchetta Dolce, Kuchengabel	2,23 €	12-120 / 12	140	3,5
L 6494	Cuchara Café Tea Spoon, Cuillère Café, Cucchiaio Caffé, Kaffeelöffel	2,23 €	12-120 / 12	140	3,5
M 6495	Cuchara Moka Coffee/Moka Spoon, Cuillère Moka, Cucchiaio Moka, Mokkalöffel	1,93 €	12-120 / 12	114	3,5
6496	24 Piezas 24 Pieces, Écrin 24 Pièces, Bauletto 24 Pz., 24 Stück	104,07 €	1-4 / 1		3,5





MARANTA VINTAGE

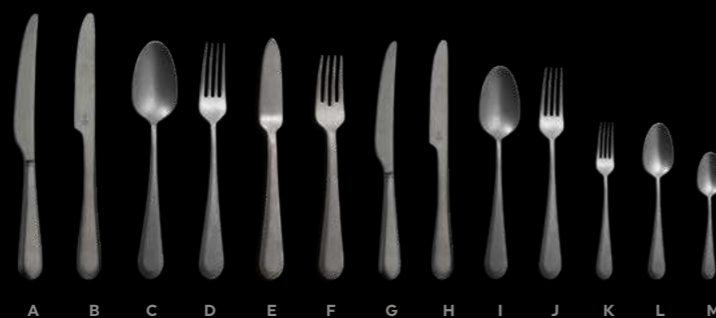

MARANTA VINTAGE

INOX 18/10 / 4mm / Vintage



REF.	Descripción	€	UE/MOQ	▶ mm	✂ mm
A 7784	Cuchillo Mesa Clasico Classic Table Knife, Couteau Table Classic, Coltello Tavola Classic, Tafelmesser Classic	4,39 €	12-120 / 12	238	
B 6793	Cuchillo Mesa Table Knife, Couteau Table, Coltello Tavola, Tafelmesser	4,26 €	12-120 / 12	238	
C 6794	Cuchara Mesa Table Spoon, Cuillère Table, Cucchiao Tavola, Tafelöffel	4,12 €	12-120 / 12	212	4
D 6795	Tenedor Mesa Table Fork, Fourchette Table, Forchetta Tavola, Tafelgabel	4,12 €	12-120 / 12	212	4
E 6796	Pala Pescado Fish Knife, Couteau Poisson, Coltello Pesce, Fischmesser	4,12 €	12-120 / 12	215	4
F 6797	Tenedor Pescado Fish Fork, Fourchette Poisson, Forchetta Pesce, Fischgabel	4,12 €	12-120 / 12	200	4
G 6692	Cuchillo Postre Clasico Classic Dessert Knife, Couteau Dessert Classic, Coltello Frutta Classic, Dessert-messer Classic	4,01 €	12-120 / 12	214	
H 6798	Cuchillo Postre Dessert Knife, Couteau Dessert, Coltello Frutta, Dessertmesser	3,92 €	12-120 / 12	214	
I 6799	Cuchara Postre Dessert Spoon, Cuillère Dessert, Cucchiao Frutta, Dessertlöffel	3,55 €	12-120 / 12	191	3,5
J 6800	Tenedor Postre Dessert Fork, Fourchette Dessert, Forchetta Frutta, Dessertgabel	3,55 €	12-120 / 12	191	3,5
K 6801	Tenedor Lunch Cake Fork, Fourchette Gâteau, Forchetta Dolce, Kuchengabel	2,68 €	12-120 / 12	140	3,5
L 6802	Cuchara Café Tea Spoon, Cuillère Café, Cucchiao Caffé, Kaffeelöffel	2,68 €	12-120 / 12	140	3,5
M 6803	Cuchara Moka Coffee/Moka Spoon, Cuillère Moka, Cucchiao Moka, Mokkalöffel	2,51 €	12-120 / 12	114	3,5
6804	24 Piezas 24 Pieces, Écrin 24 Pièces, Bauletto 24 Pz, 24 Stück	116,81 €	1-4 / 1		4





LONDON

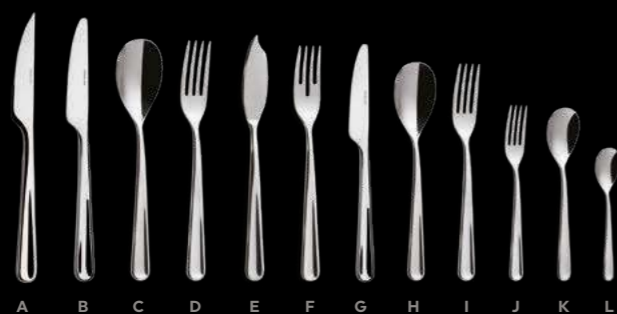

LONDON

INOX 18/10 / 4mm / Mirror



REF.	Descripción	€	UE/MOQ	▶ mm	✂ mm
A 6700	Cuchillo Chuletero Steak Knife, Couteau Steak, Coltello Bistecca, Steakmesser	3,14 €	12-120 / 12	233	
B 6701	Cuchillo Mesa Table Knife, Couteau Table, Coltello Tavola, Tafelmesser	3,14 €	12-120 / 12	228	
C 6702	Cuchara Mesa Table Spoon, Cuillère Table, Cucchiario Tavola, Tafellöffel	2,92 €	12-120 / 12	208	4
D 6703	Tenedor Mesa Table Fork, Fourchette Table, Forchetta Tavola, Tafelgabel	2,92 €	12-120 / 12	208	4
E 6497	Pala Pescado Fish Knife, Couteau Poisson, Coltello Pesce, Fischmesser	2,91 €	12-120 / 12	212	4
F 6498	Tenedor Pescado Fish Fork, Fourchette Poisson, Forchetta Pesce, Fischgabel	2,90 €	12-120 / 12	205	4
G 6704	Cuchillo Postre Dessert Knife, Couteau Dessert, Coltello Frutta, Dessertmesser	2,94 €	12-120 / 12	208	
H 6705	Cuchara Postre Dessert Spoon, Cuillère Dessert, Cucchiario Frutta, Dessertlöffel	2,64 €	12-120 / 12	186	3,5
I 6706	Tenedor Postre Dessert Fork, Fourchette Dessert, Forchetta Frutta, Dessertgabel	2,64 €	12-120 / 12	186	3,5
J 6707	Tenedor Lunch Cake Fork, Fourchette Gâteau, Forchetta Dolce, Kuchengabel	1,61 €	12-120 / 12	152	2,5
K 6708	Cuchara Café Tea Spoon, Cuillère Café, Cucchiario Caffé, Kaffeelöffel	1,61 €	12-120 / 12	150	2,5
L 6709	Cuchara Moka Coffee/Moka Spoon, Cuillère Moka, Cucchiario Moka, Mokkalöffel	1,37 €	12-120 / 12	115	2
6710	24 Piezas 24 Pieces, Écrin 24 Pièces, Bauletto 24 Pz., 24 Stück	80,78 €	1-4 / 1		4





LONDON VINTAGE

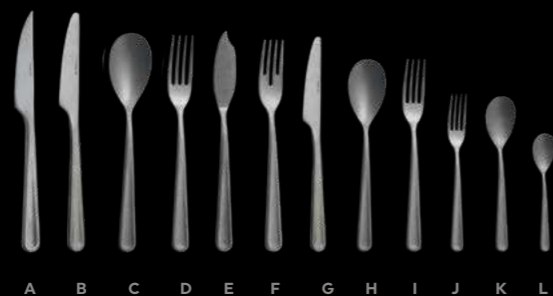

LONDON VINTAGE

INOX 18/10 / 4mm / Vintage



REF.	Descripción	€	UE/MOQ	▶ mm	✂ mm
A 6805	Cuchillo Chuletero Steak Knife, Couteau Steak, Coltello Bistecca, Steakmesser	3,89 €	12-120 / 12	233	
B 6806	Cuchillo Mesa Table Knife, Couteau Table, Coltello Tavola, Tafelmesser	3,89 €	12-120 / 12	228	
C 6807	Cuchara Mesa Table Spoon, Cuillère Table, Cucchiaio Tavola, Tafellöffel	3,66 €	12-120 / 12	208	4
D 6808	Tenedor Mesa Table Fork, Fourchette Table, Forchetta Tavola, Tafelgabel	3,66 €	12-120 / 12	208	4
E 6809	Pala Pescado Fish Knife, Couteau Poisson, Coltello Pesce, Fischmesser	3,64 €	12-120 / 12	212	4
F 6810	Tenedor Pescado Fish Fork, Fourchette Poisson, Forchetta Pesce, Fischgabel	3,64 €	12-120 / 12	205	4
G 6811	Cuchillo Postre Dessert Knife, Couteau Dessert, Coltello Frutta, Dessertmesser	3,68 €	12-120 / 12	208	
H 6812	Cuchara Postre Dessert Spoon, Cuillère Dessert, Cucchiaio Frutta, Dessertlöffel	3,39 €	12-120 / 12	186	3,5
I 6813	Tenedor Postre Dessert Fork, Fourchette Dessert, Forchetta Frutta, Dessertgabel	3,39 €	12-120 / 12	186	3,5
J 6814	Tenedor Lunch Cake Fork, Fourchette Gâteau, Forchetta Dolce, Kuchengabel	2,45 €	12-120 / 12	152	2,5
K 6815	Cuchara Café Tea Spoon, Cuillère Café, Cucchiaio Caffé, Kaffeelöffel	2,45 €	12-120 / 12	150	2,5
L 6816	Cuchara Moka Coffee/Moka Spoon, Cuillère Moka, Cucchiaio Moka, Mokkalöffel	2,22 €	12-120 / 12	115	2
6817	24 Piezas 24 Pieces, Écrin 24 Pièces, Bauletto 24 Pz, 24 Stück	94,88 €	1-4 / 1		4



VIOLET

INOX 18/10 / 4mm / Mirror

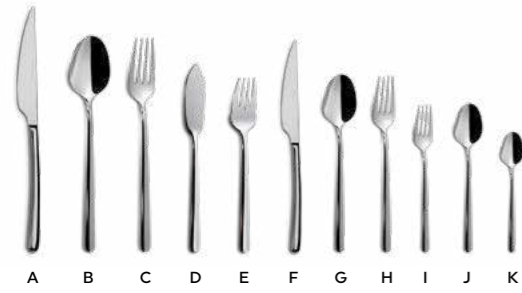

NEW



VIOLET SATIN

INOX Nickel Free 18% / 4mm / Satin

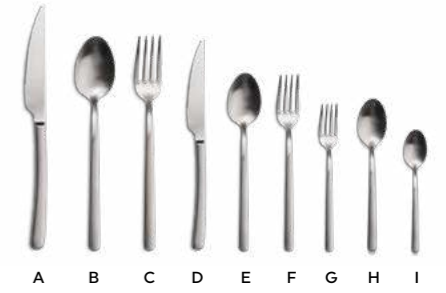

REF.	Descripción	€	UE/MOQ	▶ mm	✂ mm
A 7046	Cuchillo Mesa Table Knife, Couteau Table, Coltello Tavola, Tafelmesser	4,39 €	12-120 / 12	240	
B 7047	Cuchara Mesa Table Spoon, Cuillère Table, Cucchiaino Tavola, Tafellöffel	3,33 €	12-120 / 12	214	4
C 7048	Tenedor Mesa Table Fork, Fourchette Table, Forchetta Tavola, Tafelgabel	3,33 €	12-120 / 12	213	4
D 7049	Pala Pescado Fish Knife, Couteau Poisson, Coltello Pesce, Fischmesser	3,20 €	12-120 / 12	187	3,5
E 7050	Tenedor Pescado Fish Fork, Fourchette Poisson, Forchetta Pesce, Fischgabel	3,20 €	12-120 / 12	174	3,5
F 7051	Cuchillo Postre Dessert Knife, Couteau Dessert, Coltello Frutta, Dessertmesser	3,90 €	12-120 / 12	209	
G 7052	Cuchara Postre Dessert Spoon, Cuillère Dessert, Cucchiaino Frutta, Dessertlöffel	2,95 €	12-120 / 12	176	3,5
H 7053	Tenedor Postre Dessert Fork, Fourchette Dessert, Forchetta Frutta, Dessertgabel	2,95 €	12-120 / 12	175	3,5
I 7054	Tenedor Lunch Cake Fork, Fourchette Gâteau, Forchetta Dolce, Kuchengabel	2,22 €	12-120 / 12	147	3
J 7055	Cuchara Café Tea Spoon, Cuillère Café, Cucchiaino Caffé, Kaffeelöffel	2,22 €	12-120 / 12	147	3
K 7056	Cuchara Moka Coffee/Moka Spoon, Cuillère Moka, Cucchiaino Moka, Mokkalöffel	2,08 €	12-120 / 12	121	2,5



REF.	Descripción	€	UE/MOQ	▶ mm	✂ mm
A 12099	Cuchillo Mesa Table Knife, Couteau Table, Coltello Tavola, Tafelmesser	2,75 €	12-120 / 12	240	
B 12100	Cuchara Mesa Table Spoon, Cuillère Table, Cucchiaino Tavola, Tafellöffel	1,88 €	12-120 / 12	214	4
C 12101	Tenedor Mesa Table Fork, Fourchette Table, Forchetta Tavola, Tafelgabel	1,88 €	12-120 / 12	213	4
D 12102	Cuchillo Postre Dessert Knife, Couteau Dessert, Coltello Frutta, Dessertmesser	2,50 €	12-120 / 12	209	
E 12103	Cuchara Postre Dessert Spoon, Cuillère Dessert, Cucchiaino Frutta, Dessertlöffel	1,55 €	12-120 / 12	176	3,5
F 12104	Tenedor Postre Dessert Fork, Fourchette Dessert, Forchetta Frutta, Dessertgabel	1,55 €	12-120 / 12	175	3,5
G 12105	Tenedor Lunch Cake Fork, Fourchette Gâteau, Forchetta Dolce, Kuchengabel	1,13 €	12-120 / 12	147	3
H 12106	Cuchara Café Tea Spoon, Cuillère Café, Cucchiaino Caffé, Kaffeelöffel	1,13 €	12-120 / 12	147	3
I 12107	Cuchara Moka Coffee/Moka Spoon, Cuillère Moka, Cucchiaino Moka, Mokkalöffel	1,00 €	12-120 / 12	121	2,5



5962 24 Piezas
24 Pieces, Écrin 24 Pièces, Bauletto 24 Pz., 24 Stück

12108 24 Piezas
24 Pieces, Écrin 24 Pièces, Bauletto 24 Pz., 24 Stück

VIOLET SATIN CHAMPAGNE

INOX Nickel Free 18% / 4mm / Satin

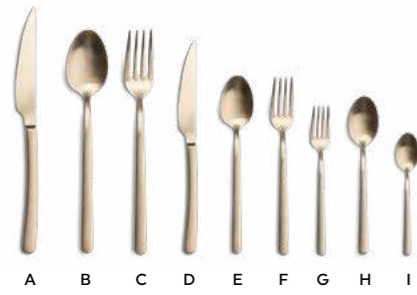

NEW

NEW

VIOLET SATIN COPPER

INOX Nickel Free 18% / 4mm / Satin

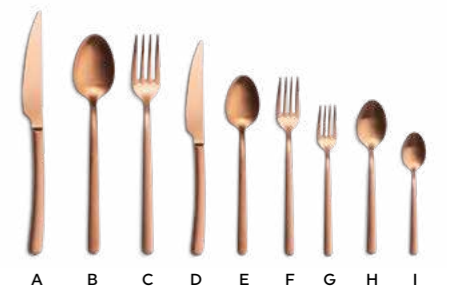

REF.	Descripción	€	UE/MOQ	▶ mm	✂ mm
A 12109	Cuchillo Mesa Table Knife, Couteau Table, Coltello Tavola, Tafelmesser	4,38 €	12-120 / 12	240	
B 12110	Cuchara Mesa Table Spoon, Cuillère Table, Cucchiaino Tavola, Tafellöffel	3,50 €	12-120 / 12	214	4
C 12111	Tenedor Mesa Table Fork, Fourchette Table, Forchetta Tavola, Tafelgabel	3,50 €	12-120 / 12	213	4
D 12112	Cuchillo Postre Dessert Knife, Couteau Dessert, Coltello Frutta, Dessertmesser	4,00 €	12-120 / 12	209	
E 12113	Cuchara Postre Dessert Spoon, Cuillère Dessert, Cucchiaino Frutta, Dessertlöffel	3,25 €	12-120 / 12	176	3,5
F 12114	Tenedor Postre Dessert Fork, Fourchette Dessert, Forchetta Frutta, Dessertgabel	3,25 €	12-120 / 12	175	3,5
G 12115	Tenedor Lunch Cake Fork, Fourchette Gâteau, Forchetta Dolce, Kuchengabel	2,75 €	12-120 / 12	147	3
H 12116	Cuchara Café Tea Spoon, Cuillère Café, Cucchiaino Caffé, Kaffeelöffel	2,75 €	12-120 / 12	147	3
I 12117	Cuchara Moka Coffee/Moka Spoon, Cuillère Moka, Cucchiaino Moka, Mokkalöffel	2,50 €	12-120 / 12	121	2,5
12118	24 Piezas 24 Pieces, Écrin 24 Pièces, Bauletto 24 Pz., 24 Stück	75,00 €	1-4 / 1		4



REF.	Descripción	€	UE/MOQ	▶ mm	✂ mm
A 12119	Cuchillo Mesa Table Knife, Couteau Table, Coltello Tavola, Tafelmesser	4,38 €	12-120 / 12	240	
B 12120	Cuchara Mesa Table Spoon, Cuillère Table, Cucchiaino Tavola, Tafellöffel	3,50 €	12-120 / 12	214	4
C 12121	Tenedor Mesa Table Fork, Fourchette Table, Forchetta Tavola, Tafelgabel	3,50 €	12-120 / 12	213	4
D 12122	Cuchillo Postre Dessert Knife, Couteau Dessert, Coltello Frutta, Dessertmesser	4,00 €	12-120 / 12	209	
E 12123	Cuchara Postre Dessert Spoon, Cuillère Dessert, Cucchiaino Frutta, Dessertlöffel	3,25 €	12-120 / 12	176	3,5
F 12124	Tenedor Postre Dessert Fork, Fourchette Dessert, Forchetta Frutta, Dessertgabel	3,25 €	12-120 / 12	175	3,5
G 12125	Tenedor Lunch Cake Fork, Fourchette Gâteau, Forchetta Dolce, Kuchengabel	2,75 €	12-120 / 12	147	3
H 12126	Cuchara Café Tea Spoon, Cuillère Café, Cucchiaino Caffé, Kaffeelöffel	2,75 €	12-120 / 12	147	3
I 12127	Cuchara Moka Coffee/Moka Spoon, Cuillère Moka, Cucchiaino Moka, Mokkalöffel	2,50 €	12-120 / 12	121	2,5
12128	24 Piezas 24 Pieces, Écrin 24 Pièces, Bauletto 24 Pz., 24 Stück	75,00 €	1-4 / 1		4



CHEF

INOX 18/10 / 4mm / Mirror



A



LOTUS

INOX 18/10 / 4mm / Mirror

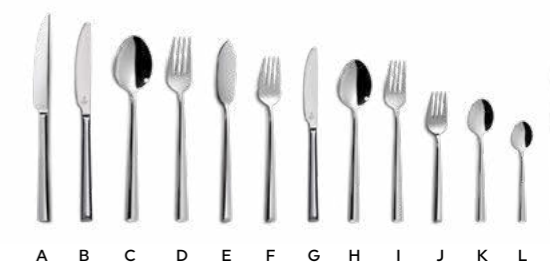

REF.	Descripción	€	UE/MOQ	▶ mm	✂ mm
A 3107	Cuchillo Chuletero Sutil Steak Knife Sutil, Couteau Steak Sutil, Coltello Bistecca Sutil, Steakmesser Sutil	3,72 €	12-120 / 12	232	
B 5033	Cuchillo Mesa Table Knife, Couteau Table, Coltello Tavola, Tafelmesser	3,20 €	12-120 / 12	235	
C 11915	Cuchara Mesa Table Spoon, Cuillère Table, Cucchiaino Tavola, Tafellöffel	2,87 €	12-120 / 12	200	4
D 11916	Tenedor Mesa Table Fork, Fourchette Table, Forchetta Tavola, Tafelgabel	2,87 €	12-120 / 12	200	4
E 3702	Pala Pescado Fish Knife, Couteau Poisson, Coltello Pesce, Fischmesser	2,76 €	12-120 / 12	205	3
F 3703	Tenedor Pescado Fish Fork, Fourchette Poisson, Forchetta Pesce, Fischgabel	2,76 €	12-120 / 12	195	3
G 5034	Cuchillo Postre Dessert Knife, Couteau Dessert, Coltello Frutta, Dessertmesser	2,89 €	12-120 / 12	210	2,5
H 3704	Cuchara Postre Dessert Spoon, Cuillère Dessert, Cucchiaino Frutta, Dessertlöffel	2,45 €	12-120 / 12	180	2,5
I 3705	Tenedor Postre Dessert Fork, Fourchette Dessert, Forchetta Frutta, Dessertgabel	2,45 €	12-120 / 12	180	2,5
J 3706	Tenedor Lunch Cake Fork, Fourchette Gâteau, Forchetta Dolce, Kuchengabel	1,68 €	12-120 / 12	148	2
K 3707	Cuchara Café Tea Spoon, Cuillère Café, Cucchiaino Caffé, Kaffeelöffel	1,68 €	12-120 / 12	140	2
L 3708	Cuchara Moka Coffee/Moka Spoon, Cuillère Moka, Cucchiaino Moka, Mokkalöffel	1,49 €	12-120 / 12	116	2
0706	24 Piezas 24 Pieces, Écrin 24 Pièces, Bauletto 24 Pz., 24 Stück	71,56 €	1-4 / 1		3,5



REF.	Descripción	€	UE/MOQ	▶ mm	✂ mm
A 6696	Cuchillo Chuletero Steak Knife, Couteau Steak, Coltello Bistecca, Steakmesser	3,16 €	12-120 / 12	235	
B 3139	Cuchillo Mesa Table Knife, Couteau Table, Coltello Tavola, Tafelmesser	3,16 €	12-120 / 12	225	
C 3141	Cuchara Mesa Table Spoon, Cuillère Table, Cucchiaino Tavola, Tafellöffel	3,33 €	12-120 / 12	211	4
D 3142	Tenedor Mesa Table Fork, Fourchette Table, Forchetta Tavola, Tafelgabel	3,33 €	12-120 / 12	211	4
E 3143	Pala Pescado Fish Knife, Couteau Poisson, Coltello Pesce, Fischmesser	2,52 €	12-120 / 12	206	3,5
F 3144	Tenedor Pescado Fish Fork, Fourchette Poisson, Forchetta Pesce, Fischgabel	2,52 €	12-120 / 12	186	3,5
G 3145	Cuchillo Postre Dessert Knife, Couteau Dessert, Coltello Frutta, Dessertmesser	2,74 €	12-120 / 12	195	
H 3146	Cuchara Postre Dessert Spoon, Cuillère Dessert, Cucchiaino Frutta, Dessertlöffel	2,68 €	12-120 / 12	188	3,5
I 3147	Tenedor Postre Dessert Fork, Fourchette Dessert, Forchetta Frutta, Dessertgabel	2,68 €	12-120 / 12	186	3,5
J 3148	Tenedor Lunch Cake Fork, Fourchette Gâteau, Forchetta Dolce, Kuchengabel	2,00 €	12-120 / 12	147	3
K 3149	Cuchara Café Tea Spoon, Cuillère Café, Cucchiaino Caffé, Kaffeelöffel	2,00 €	12-120 / 12	139	3
L 3150	Cuchara Moka Coffee/Moka Spoon, Cuillère Moka, Cucchiaino Moka, Mokkalöffel	1,50 €	12-120 / 12	114	2,5
M 3176	Pala Mantequilla Butter Knife, Couteau Beurre, Coltello Burro, Buttermesser	2,56 €	12-120 / 12	180	3
5960	24 Piezas 24 Pieces, Écrin 24 Pièces, Bauletto 24 Pz., 24 Stück	85,77 €	1-4 / 1		4





MUNICH

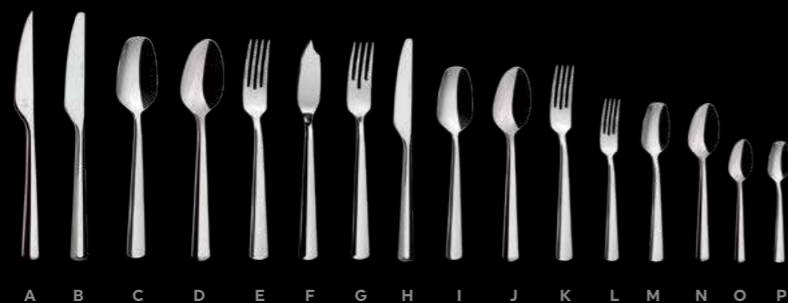

MUNICH

INOX 18/10 / 3,5mm / Mirror



* Añadimos cuchara CLÁSICA a la colección, dando la posibilidad de adaptar la gama Munich a distintos estilos.

We add CLASSIC spoon to the collection, giving the possibility to adapt the Munich range to different styles.

REF.	Descripción	€	UE/MOQ	▶ mm	✂ mm
A 6511	Cuchillo Chuletero Steak Knife, Couteau Steak, Coltello Bistecca, Steakmesser	3,07 €	12-120 / 12	237	
B 6512	Cuchillo Mesa Table Knife, Couteau Table, Coltello Tavola, Tafelmesser	3,08 €	12-120 / 12	235	
C 6513	Cuchara Mesa Table Spoon, Cuillère Table, Cucchiaio Tavola, Tafellöffel	2,90 €	12-120 / 12	210	3,5
D 11935	Cuchara Mesa Clasica Classic Table Spoon, Cuillère Table Classic, Cucchiaio Tavola Classic, Tafellöffel Classic	2,90 €	12-120 / 12	210	3,5
E 6514	Tenedor Mesa Table Fork, Fourchette Table, Forchetta Tavola, Tafelgabel	2,90 €	12-120 / 12	209	3,5
F 6515	Pala Pescado Fish Knife, Couteau Poisson, Coltello Pesce, Fischmesser	2,77 €	12-120 / 12	210	3
G 6516	Tenedor Pescado Fish Fork, Fourchette Poisson, Forchetta Pesce, Fischgabel	2,77 €	12-120 / 12	207	3
H 6517	Cuchillo Postre Dessert Knife, Couteau Dessert, Coltello Frutta, Dessertmesser	2,90 €	12-120 / 12	209	
I 6518	Cuchara Postre Dessert Spoon, Cuillère Dessert, Cucchiaio Frutta, Dessertlöffel	2,62 €	12-120 / 12	182	3
J 11936	Cuchara Postre Clasica Classic Dessert Spoon, Cuillère Dessert Classic, Cucchiaio Frutta Classic, Dessertlöffel Classic	2,62 €	12-120 / 12	185	3
K 6519	Tenedor Postre Dessert Fork, Fourchette Dessert, Forchetta Frutta, Dessertgabel	2,62 €	12-120 / 12	186	3
L 6520	Tenedor Lunch Cake Fork, Fourchette Gâteau, Forchetta Dolce, Kuchengabel	1,78 €	12-120 / 12	153	2,5
M 6521	Cuchara Café Tea Spoon, Cuillère Café, Cucchiaio Caffé, Kaffeelöffel	1,78 €	12-120 / 12	150	2,5
N 11937	Cuchara Café Clasica Classic Tea Spoon, Cuillère Café Classic, Cucchiaio Caffé Classic, Kaffeelöffel Classic	1,78 €	12-120 / 12	150	2,5
O 6522	Cuchara Moka Coffee/Moka Spoon, Cuillère Moka, Cucchiaio Moka, Mokkalöffel	1,60 €	12-120 / 12	115	2,5
P 11938	Cuchara Moka Clasica Classic Coffee/Moka Spoon, Cuillère Moka Classic, Cucchiaio Moka Classic, Mokkalöffel Classic	1,60 €	12-120 / 12	115	2,5
6523	24 Piezas 24 Pieces, Écrin 24 Pièces, Bauletto 24 Pz., 24 Stück	71,56 €	1-4 / 1		3,5





IBIZA

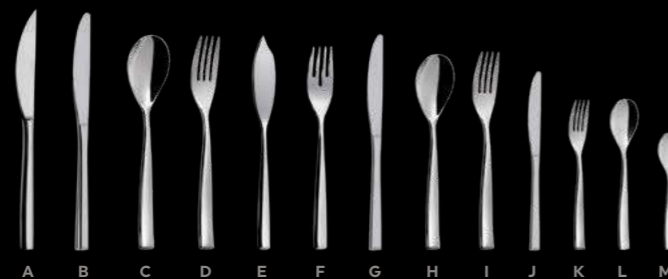

IBIZA

INOX 18/10 / 3,5mm / Mirror



REF.	Descripción	€	UE/MOQ	▶ mm	✂ mm
A 0764	Cuchillo Chuletero Steak Knife, Couteau Steak, Coltello Bistecca, Steakmesser	3,19 €	12-120 / 12	223	
B 0268	Cuchillo Mesa Table Knife, Couteau Table, Coltello Tavola, Tafelmesser	3,19 €	12-120 / 12	221	
C 2736	Cuchara Mesa Table Spoon, Cuillère Table, Cucchiaino Tavola, Tafelöffel	3,03 €	12-120 / 12	200	3,5
D 2735	Tenedor Mesa Table Fork, Fourchette Table, Forchetta Tavola, Tafelgabel	3,03 €	12-120 / 12	200	3,5
E 2742	Pala Pescado Fish Knife, Couteau Poisson, Coltello Pesce, Fischmesser	2,62 €	12-120 / 12	200	2,5
F 2741	Tenedor Pescado Fish Fork, Fourchette Poisson, Forchetta Pesce, Fischgabel	2,62 €	12-120 / 12	190	2,5
G 5807	Cuchillo Postre Dessert Knife, Couteau Dessert, Coltello Frutta, Dessertmesser	2,98 €	12-120 / 12	202	
H 2740	Cuchara Postre Dessert Spoon, Cuillère Dessert, Cucchiaino Frutta, Dessertlöffel	2,62 €	12-120 / 12	183	2,5
I 2738	Tenedor Postre Dessert Fork, Fourchette Dessert, Forchetta Frutta, Dessertgabel	2,62 €	12-120 / 12	185	2,5
J 5814	Cuchillo Lunch Cake Knife, Couteau Gâteau, Coltello Dolce, Küchenmesser	2,74 €	12-120 / 12	167	
K 2745	Tenedor Lunch Cake Fork, Fourchette Gâteau, Forchetta Dolce, Kuchengabel	1,58 €	12-120 / 12	140	2,5
L 2743	Cuchara Café Tea Spoon, Cuillère Café, Cucchiaino Caffé, Kaffeelöffel	1,58 €	12-120 / 12	140	2,5
M 2744	Cuchara Moka Coffee/Moka Spoon, Cuillère Moka, Cucchiaino Moka, Mokkalöffel	1,48 €	12-120 / 12	110	2,5
2797	24 Piezas 24 Pieces, Écrin 24 Pièces, Bauletto 24 Pz, 24 Stück	71,56 €	1-4 / 1		3,5





REF.	Descripción	€	UE/MOQ	▶ mm	✂ mm
A 5821	Cuchillo Mesa Table Knife, Couteau Table, Coltello Tavola, Tafelmesser	3,19 €	12-120 / 12	229	
B 5822	Cuchara Mesa Table Spoon, Cuillère Table, Cucchiaio Tavola, Tafellöffel	3,01 €	12-120 / 12	205	3,5
C 5823	Tenedor Mesa Table Fork, Fourchette Table, Forchetta Tavola, Tafelgabel	3,01 €	12-120 / 12	205	3,5
D 5824	Pala Pescado Fish Knife, Couteau Poisson, Coltello Pesce, Fischmesser	2,64 €	12-120 / 12	215	3,5
E 5825	Tenedor Pescado Fish Fork, Fourchette Poisson, Forchetta Pesce, Fischgabel	2,64 €	12-120 / 12	195	3,5
F 5826	Cuchillo Postre Dessert Knife, Couteau Dessert, Coltello Frutta, Dessertmesser	2,72 €	12-120 / 12	200	
G 5827	Cuchara Postre Dessert Spoon, Cuillère Dessert, Cucchiaio Frutta, Dessertlöffel	2,71 €	12-120 / 12	190	3,5
H 5828	Tenedor Postre Dessert Fork, Fourchette Dessert, Forchetta Frutta, Dessertgabel	2,71 €	12-120 / 12	185	3,5
I 5829	Tenedor Lunch Cake Fork, Fourchette Gâteau, Forchetta Dolce, Kuchengabel	1,79 €	12-120 / 12	140	2,5
J 5830	Cuchara Café Tea Spoon, Cuillère Café, Cucchiaio Caffé, Kaffeelöffel	1,79 €	12-120 / 12	147	2,5
K 5831	Cuchara Moka Coffee/Moka Spoon, Cuillère Moka, Cucchiaio Moka, Mokkalöffel	1,45 €	12-120 / 12	110	2
L 3158	Cuchara Consomé Consommé Spoon, Cuillère Consommé, Cucchiaio Zuppa, Bouillonlöffel	2,80 €	12-120 / 12	180	2,5
M 0463	Cazo Sopa Soup Ladle, Louche À Potage, Mestolo, Suppenkelle	12,52 €	10-50 / 10	280	3,5
N 0464	Cuchara Ensalada Salad Spoon, Cuillère À Servir Salade, Cucchiaio Servire, Salatlöffel	8,58 €	10-50 / 10	275	3,5
O 0465	Tenedor Ensalada Salad Fork, Fourchette À Servir Salade, Forchetta Servire, Salatgabel	8,58 €	10-50 / 10	275	3,5
P 0466	Pala Repostería Cake Server, Pelle À Tarte, Pala Torta, Tortenheber	6,40 €	10-50 / 10	260	3,5
Q 0467	Cazo Salsa Sauce Ladle, Cuillère À Sauce, Mestolino Salsa, Soßenkelle	10,32 €	10-50 / 10	180	3,5
2900	24 Piezas 24 Pieces, Écrin 24 Pièces, Bauletto 24 Pz, 24 Stück	72,12 €	1-4 / 1		3,5

ONLINE



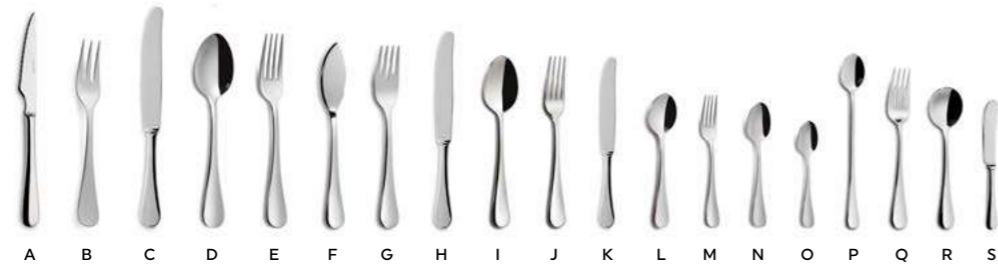

REF.	Descripción	€	UE/MOQ	▶ mm	✂ mm
A 4402	Cuchillo Chuletero Steak Knife, Couteau Steak, Coltello Bistecca, Steakmesser	3,36 €	12-120 / 12	228	
B 5525	Tenedor Chuletero Steak Fork, Fourchette Steak, Forchetta Bistecca, Steakgabel	2,99 €	12-120 / 12	202	3
C 11923	Cuchillo Mesa Clasico Classic Table Knife, Couteau Table Classic, Coltello Tavola Classic, Tafelmesser Classic	3,43 €	12-120 / 12	240	
D 4536	Cuchara Mesa Table Spoon, Cuillère Table, Cucchiaio Tavola, Tafellöffel	3,02 €	12-120 / 12	210	3
E 4537	Tenedor Mesa Table Fork, Fourchette Table, Forchetta Tavola, Tafelgabel	3,02 €	12-120 / 12	210	3
F 5376	Pala Pescado Fish Knife, Couteau Poisson, Coltello Pesce, Fischmesser	2,92 €	12-120 / 12	200	3
G 5377	Tenedor Pescado Fish Fork, Fourchette Poisson, Forchetta Pesce, Fischgabel	2,92 €	12-120 / 12	195	3
H 11924	Cuchillo Postre Clasico Classic Dessert Knife, Couteau Dessert Classic, Coltello Frutta Classic, Dessertmesser Classic	3,08 €	12-120 / 12	216	
I 5378	Cuchara Postre Dessert Spoon, Cuillère Dessert, Cucchiaio Frutta, Dessertlöffel	2,60 €	12-120 / 12	185	2,5
J 5379	Tenedor Postre Dessert Fork, Fourchette Dessert, Forchetta Frutta, Dessertgabel	2,60 €	12-120 / 12	185	2,5
K 11925	Cuchillo Lunch Clasico Classic Cake Knife, Couteau Gâteau Classic, Coltello Dolce Classic, Kuchenmesser Classic	2,83 €	12-120 / 12	176	
L 3846	Cuchara Té Iced Tea Spoon, Cuillère À Té, Cucchiaio The, Cocktaillöffel	1,73 €	12-120 / 12	145	2
M 11926	Tenedor Lunch Cake Fork, Fourchette Gâteau, Forchetta Dolce, Kuchengabel	1,66 €	12-120 / 12	148	2
N 3948	Cuchara Café Tea Spoon, Cuillère Café, Cucchiaio Caffé, Kaffeelöffel	1,65 €	12-120 / 12	135	2
O 3949	Cuchara Moka Coffee/Moka Spoon, Cuillère Moka, Cucchiaio Moka, Mokkalöffel	1,46 €	12-120 / 12	115	2
P 4993	Cuchara Refresco Soda Spoon, Cuillère Mazagran, Cucchiaio Bibita, Longdrinklöffel	2,22 €	12-120 / 12	207	2
Q 5533	Tenedor Arroz Rice Fork, Fourchette À Riz, Forchetta Riso, Reisgabel	3,07 €	12-120 / 12	205	2,5
R 3154	Cuchara Consomé Consommé Spoon, Cuillère Consommé, Cucchiaio Zuppa, Bouillonlöffel	2,58 €	12-120 / 12	180	2,5
S 12030	Pala Mantequilla Butter Knife, Cuillère Consommé, Cucchiaio Zuppa, Bouillonlöffel	1,89 €	12-120 / 12	176	3



REF.	Descripción	€	UE/MOQ	▶ mm	✂ mm
7119	24 Piezas 24 Pieces, Écrin 24 Pièces, Bauletto 24 Pz, 24 Stück	73,03 €	1-4 / / 1		

NORTH M

INOX 18/10 / 2.5mm / Mirror



NORTH S

INOX 18/10 / 2mm / Mirror

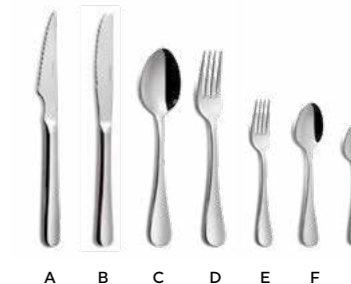

REF.	Descripción	€	UE/MOQ	▶ mm	✂ mm
A 6359	Cuchillo Mesa Grande Long Table Knife, Grande Couteau Table, Coltello Tavola Grande, Tafelmesser Lang	2,34 €	12-120 / 12	228	
B 4007	Cuchara Mesa Grande Table Spoon Long, Grande Cuillère Table, Cucchiaino Tavola Grande, Tafellöffel Lang	1,82 €	12-120 / 12	198	2,5
C 4008	Tenedor Mesa Grande Long Table Fork, Grande Fourchette Table, Forchetta Tavola Grande, Tafelgabel Lang	1,82 €	12-120 / 12	198	2,5
D 3948	Cuchara Café Tea Spoon, Cuillère Café, Cucchiaino Caffé, Kaffeelöffel	1,65 €	12-120 / 12	135	2
7120	24 Piezas 24 Pieces, Écrin 24 Pièces, Bauletto 24 Pz., 24 Stück	56,36 €	1-4 / 1		2,5



REF.	Descripción	€	UE/MOQ	▶ mm	✂ mm
A 5631	Cuchillo Chuletero Steak Knife, Couteau Steak, Coltello Bistecca, Steakmesser	2,48 €	12-120 / 12	230	
B 0094	Cuchillo Mesa Table Knife, Couteau Table, Coltello Tavola, Tafelmesser	2,48 €	12-120 / 12	225	
C 3940	Cuchara Mesa Table Spoon, Cuillère Table, Cucchiaino Tavola, Tafellöffel	1,68 €	12-120 / 12	193	1,8
D 3941	Tenedor Mesa Table Fork, Fourchette Table, Forchetta Tavola, Tafelgabel	1,68 €	12-120 / 12	190	2
E 3947	Tenedor Lunch Cake Fork, Fourchette Gâteau, Forchetta Dolce, Kuchengabel	0,91 €	12-120 / 12	143	1,5
F 5567	Cuchara Café Tea Spoon, Cuillère Café, Cucchiaino Caffé, Kaffeelöffel	0,91 €	12-120 / 12	140	1,5
G 5568	Cuchara Moka Coffee/Moka Spoon, Cuillère Moka, Cucchiaino Moka, Mokkalöffel	0,83 €	12-120 / 12	120	1,2
7122	24 Piezas 24 Pieces, Écrin 24 Pièces, Bauletto 24 Pz., 24 Stück	45,53 €	1-4 / 1		2



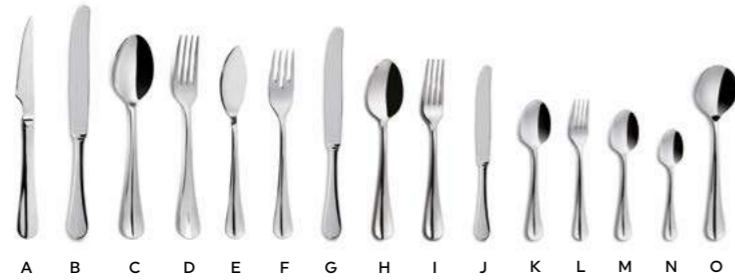

REF.	Descripción	€	UE/MOQ	▶ mm	✂ mm
A 3526	Cuchillo Chuletero Steak Knife, Couteau Steak, Coltello Bistecca, Steakmesser	3,37 €	12-120 / 12	230	
B 11923	Cuchillo Mesa Clasico Classic Table Knife, Couteau Table Classic, Coltello Tavola Classic, Tafelmesser Classic	3,43 €	12-120 / 12	240	
C 4365	Cuchara Mesa Table Spoon, Cuillère Table, Cucchiaino Tavola, Tafellöffel	3,02 €	12-120 / 12	209	3
D 4366	Tenedor Mesa Table Fork, Fourchette Table, Forchetta Tavola, Tafelgabel	3,02 €	12-120 / 12	210	3
E 5297	Pala Pescado Fish Knife, Couteau Poisson, Coltello Pesce, Fischmesser	2,71 €	12-120 / 12	200	2,5
F 5298	Tenedor Pescado Fish Fork, Fourchette Poisson, Forchetta Pesce, Fischgabel	2,71 €	12-120 / 12	195	2,5
G 11924	Cuchillo Postre Clasico Classic Dessert Knife, Couteau Dessert Classic, Coltello Frutta Classic, Dessertmesser Classic	3,08 €	12-120 / 12	216	
H 5299	Cuchara Postre Dessert Spoon, Cuillère Dessert, Cucchiaino Frutta, Dessertlöffel	2,60 €	12-120 / 12	185	2,5
I 5300	Tenedor Postre Dessert Fork, Fourchette Dessert, Forchetta Frutta, Dessertgabel	2,60 €	12-120 / 12	183	2,5
J 11925	Cuchillo Lunch Clasico Classic Cake Knife, Couteau Gâteau Classic, Coltello Dolce Classic, Kuchenmesser Classic	2,83 €	12-120 / 12	176	
K 3877	Cuchara Té Tea Spoon, Cuillère À Thé, Cucchiaino The, Cocktaillöffel	1,74 €	12-120 / 12	145	2
L 11927	Tenedor Lunch Cake Fork, Fourchette Gâteau, Forchetta Dolce, Kuchengabel	1,66 €	12-120 / 12	148	2
M 5302	Cuchara Café Tea Spoon, Cuillère Café, Cucchiaino Caffé, Kaffeelöffel	1,61 €	12-120 / 12	138	2
N 5303	Cuchara Moka Coffee/Moka Spoon, Cuillère Moka, Cucchiaino Moka, Mokkalöffel	1,46 €	12-120 / 12	117	2
O 3155	Cuchara Consomé Consommé Spoon, Cuillère Consommé, Cucchiaino Zuppa, Bouillonlöffel	3,01 €	12-120 / 12	180	2,5



REF.	Descripción	€	UE/MOQ	▶ mm	✂ mm
4883	24 Piezas 24 Pieces, Ecrin 24 Pièces, Bauletto 24 Pz., 24 Stück	71,16 €	1-4 / 1	3	



BAGUETTE S

INOX 18/10 / 2mm / Mirror

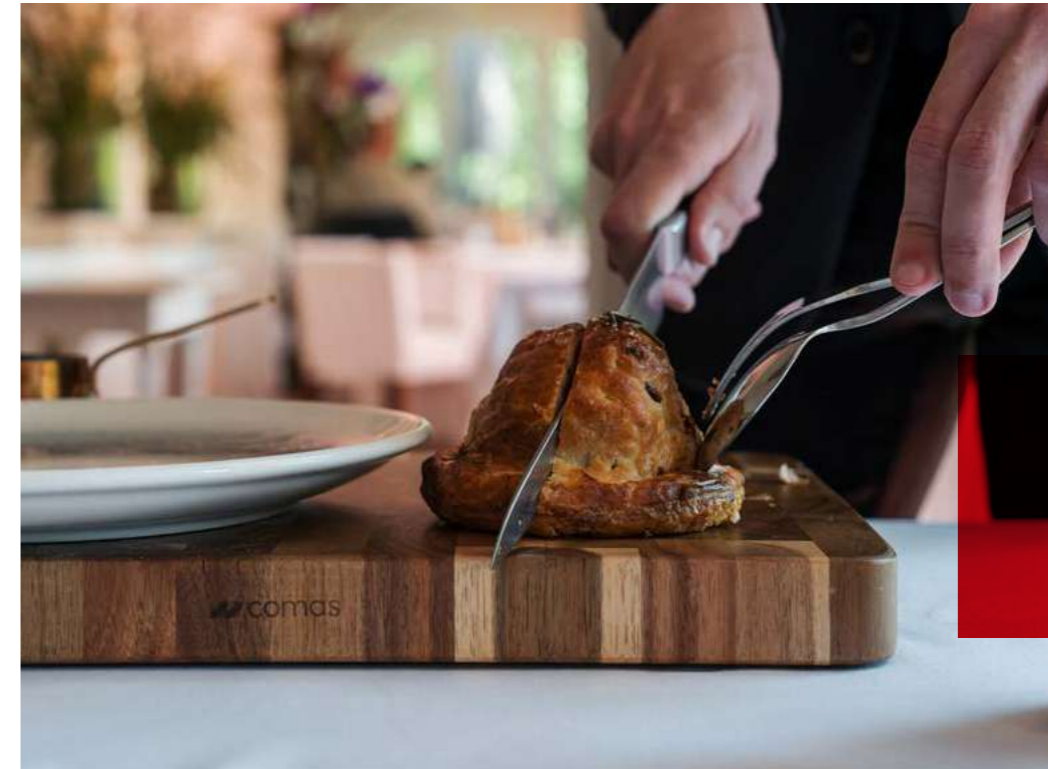
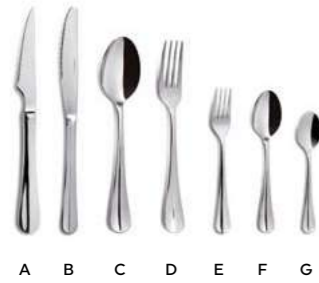

Diseño, innovación, calidad, funcionalidad, y accesibilidad.

Design, innovation, quality, functionality, and accessibility.

Cinco valores fundamentales de Comas que se demuestran entre más de cincuenta colecciones de cubiertos.

Five core values of Comas that are featured among more than fifty cutlery collections.

REF.	Descripción	€	UE/MOQ	▶ mm	✂ mm
A 1283	Cuchillo Chuletero Steak Knife, Couteau Steak, Coltello Bistecca, Steakmesser	2,49 €	12-120 / 12	223	
B 3522	Cuchillo Mesa Table Knife, Couteau Table, Coltello Tavola, Tafelmesser	2,49 €	12-120 / 12	225	
C 4377	Cuchara Mesa Table Spoon, Cuillère Table, Cucchiaio Tavola, Tafelöffel	1,68 €	12-120 / 12	193	1,8
D 4378	Tenedor Mesa Table Fork, Fourchette Table, Forchetta Tavola, Tafelgabel	1,68 €	12-120 / 12	190	2
E 4383	Tenedor Lunch Cake Fork, Fourchette Gâteau, Forchetta Dolce, Kuchengabel	0,91 €	12-120 / 12	143	1,5
F 4384	Cuchara Café Tea Spoon, Cuillère Café, Cucchiaio Caffé, Kaffeelöffel	0,91 €	12-120 / 12	140	1,5
G 4385	Cuchara Moka Coffee/Moka Spoon, Cuillère Moka, Cucchiaio Moka, Mokkalöffel	0,83 €	12-120 / 12	120	1,2
H 7121	24 Piezas 24 Pieces, Écrin 24 Pièces, Bauletto 24 Pz, 24 Stück	45,53 €	1-4 / 1		2



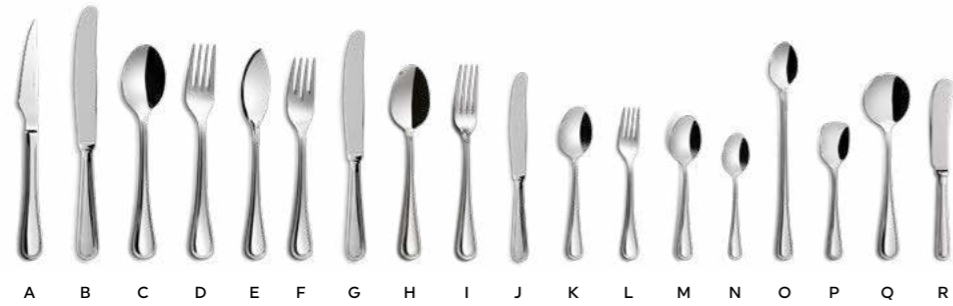

REF.	Descripción	€	UE/MOQ	▶ mm	✂ mm
A 5952	Cuchillo Chuletero Steak Knife, Couteau Steak, Coltello Bistecca, Steakmesser	3,38 €	12-120 / 12	228	
B 11917	Cuchillo Mesa Clasico Classic Table Knife, Couteau Table Classic, Coltello Tavola Classic, Tafelmesser Classic	3,41 €	12-120 / 12	240	
C 11918	Cuchara Mesa Table Spoon, Cuillère Table, Cucchiaio Tavola, Tafellöffel	2,77 €	12-120 / 12	209	3
D 11919	Tenedor Mesa Table Fork, Fourchette Table, Forchetta Tavola, Tafelgabel	2,77 €	12-120 / 12	210	3
E 5372	Pala Pescado Fish Knife, Couteau Poisson, Coltello Pesce, Fischmesser	2,69 €	12-120 / 12	200	2,5
F 5373	Tenedor Pescado Fish Fork, Fourchette Poisson, Forchetta Pesce, Fischgabel	2,60 €	12-120 / 12	195	2,5
G 11920	Cuchillo Postre Clasico Classic Dessert Knife, Couteau Dessert Classic, Coltello Frutta Classic, Dessertmesser Classic	2,99 €	12-120 / 12	217	
H 5374	Cuchara Postre Dessert Spoon, Cuillère Dessert, Cucchiaio Frutta, Dessertlöffel	2,53 €	12-120 / 12	178	2,5
I 5375	Tenedor Postre Dessert Fork, Fourchette Dessert, Forchetta Frutta, Dessertgabel	2,53 €	12-120 / 12	183	2,5
J 11921	Cuchillo Lunch Clasico Classic Cake Knife, Couteau Gâteau Classic, Coltello Dolce Classic, Kuchenmesser Classic	2,69 €	12-120 / 12	177	
K 5309	Cuchara Té Tea Spoon, Cuillère À Té, Cucchiaio The, Cocktaillöffel	1,76 €	12-120 / 12	145	2
L 11922	Tenedor Lunch Cake Fork, Fourchette Gâteau, Forchetta Dolce, Kuchengabel	1,62 €	12-120 / 12	148	2
M 5437	Cuchara Café Tea Spoon, Cuillère Café, Cucchiaio Caffé, Kaffeelöffel	1,56 €	12-120 / 12	138	2
N 5438	Cuchara Moka Coffee/Moka Spoon, Cuillère Moka, Cucchiaio Moka, Mokkalöffel	1,41 €	12-120 / 12	117	2
O 4508	Cuchara Refresco Soda Spoon, Cuillère Mazagran, Cucchiaio Bibita, Longdrinklöffel	2,19 €	12-120 / 12	207	2
P 4018	Cuchara Helado Ice Cream Spoon, Cuillère À Glace, Cucchiaio Gelato, Eiscremelöffel	1,88 €	12-120 / 12	130	2
Q 4019	Cuchara Consomé Consommé Spoon, Cuillère Consommé, Cucchiaio Zuppa, Bouillonlöffel	2,52 €	12-120 / 12	180	2,5
R 12029	Pala Mantequilla Butter Knife, Cuillère Consommé, Cucchiaio Zuppa, Bouillonlöffel	1,89 €	12-120 / 12	176	

REF.	Descripción	€	UE/MOQ	▶ mm	✂ mm
4881	24 Piezas 24 Pieces, Ecrin 24 Pièces, Bauletto 24 Pz, 24 Stück	71,16 €	1-4 / 1		2,5

INGLÉS M

INOX 18/10 / 2,5mm / Mirror



INGLÉS S

INOX 18/10 / 2mm / Mirror

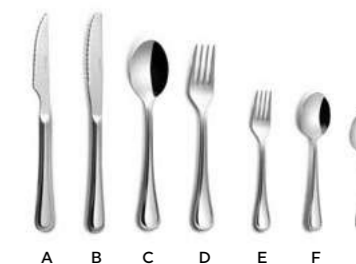

REF.	Descripción	€	UE/MOQ	▶ mm	✂ mm
A 6360	Cuchillo Mesa Grande Long Table Knife, Grande Couteau Table, Coltello Tavola Grande, Tafelmesser Lang	2,34 €	12-120 / 12	228	
B 4009	Cuchara Mesa Grande Long Table Spoon, Grande Cuillère Table, Cucchiaino Tavola Grande, Tafellöffel Lang	1,82 €	12-120 / 12	198	2,5
C 4010	Tenedor Mesa Grande Long Table Fork, Grande Fourchette Table, Forchetta Tavola Grande, Tafelgabel Lang	1,82 €	12-120 / 12	198	2,5
D 5437	Cuchara Café Tea Spoon, Cuillère Café, Cucchiaino Caffé, Kaffeelöffel	1,56 €	12-120 / 12	137	2
7123	24 Piezas 24 Pieces, Écrin 24 Pièces, Bauletto 24 Pz., 24 Stück	54,20 €	1-4 / 1		2,5



REF.	Descripción	€	UE/MOQ	▶ mm	✂ mm
A 2396	Cuchillo Chuletero Steak Knife, Couteau Steak, Coltello Bistecca, Steakmesser	2,48 €	12-120 / 12	223	
B 2338	Cuchillo Mesa Table Knife, Couteau Table, Coltello Tavola, Tafelmesser	2,48 €	12-120 / 12	222	
C 2339	Cuchara Mesa Table Spoon, Cuillère Table, Cucchiaino Tavola, Tafellöffel	1,68 €	12-120 / 12	193	1,8
D 2340	Tenedor Mesa Table Fork, Fourchette Table, Forchetta Tavola, Tafelgabel	1,68 €	12-120 / 12	190	2
E 2341	Tenedor Lunch Cake Fork, Fourchette Gâteau, Forchetta Dolce, Kuchengabel	0,89 €	12-120 / 12	143	1,5
F 2342	Cuchara Café Tea Spoon, Cuillère Café, Cucchiaino Caffé, Kaffeelöffel	0,89 €	12-120 / 12	140	1,5
G 2343	Cuchara Moka Coffee/Moka Spoon, Cuillère Moka, Cucchiaino Moka, Mokkalöffel	0,83 €	12-120 / 12	120	1,2
7124	24 Piezas 24 Pieces, Écrin 24 Pièces, Bauletto 24 Pz., 24 Stück	45,53 €	1-4 / 1		2



VIENA

INOX 18/10 / 2,5mm / Mirror



VIENA

INOX 18/10 / 2,5mm / Mirror



REF.	Descripción	€	UE/MOQ	▶ mm	✂ mm
A 5307	Cuchillo Chuletero Steak Knife, Couteau Steak, Coltello Bistecca, Steakmesser	3,37 €	12-120 / 12	228	
B 4777	Cuchillo Mesa Table Knife, Couteau Table, Coltello Tavola, Tafelmesser	3,37 €	12-120 / 12	240	
C 4714	Cuchara Mesa Table Spoon, Cuillère Table, Cucchialo Tavola, Tafellöffel	2,74 €	12-120 / 12	210	2,5
D 4715	Tenedor Mesa Table Fork, Fourchette Table, Forchetta Tavola, Tafelgabel	2,74 €	12-120 / 12	210	2,5
E 4716	Pala Pescado Fish Knife, Couteau Poisson, Coltello Pesce, Fischmesser	2,69 €	12-120 / 12	210	2,5
F 4717	Tenedor Pescado Fish Fork, Fourchette Poisson, Forchetta Pesce, Fischgabel	2,69 €	12-120 / 12	196	2,5
G 4778	Cuchillo Postre Dessert Knife, Couteau Dessert, Coltello Frutta, Dessertmesser	2,97 €	12-120 / 12	210	
H 4721	Cuchara Postre Dessert Spoon, Cuillère Dessert, Cucchialo Frutta, Dessertlöffel	2,51 €	12-120 / 12	191	2,5
I 4722	Tenedor Postre Dessert Fork, Fourchette Dessert, Forchetta Frutta, Dessertgabel	2,51 €	12-120 / 12	195	2,5
J 4718	Tenedor Lunch Cake Fork, Fourchette Gâteau, Forchetta Dolce, Kuchengabel	1,81 €	12-120 / 12	160	2
K 4719	Cuchara Café Tea Spoon, Cuillère Café, Cucchialo Caffé, Kaffeelöffel	1,78 €	12-120 / 12	155	2
L 4720	Cuchara Moka Coffee/Moka Spoon, Cuillère Moka, Cucchialo Moka, Mokkalöffel	1,58 €	12-120 / 12	133	1,8
M 4781	Cazo Sopa Soup Ladle, Louche À Potage, Mestolo, Suppenkelle	11,09 €	10-50 / 10	280	2,5
N 4780	Cuchara Ensalada Salad Spoon, Cuillère À Servir Salade, Cucchialo Servire, Salatlöffel	7,42 €	10-50 / 10	240	2,5
O 4779	Tenedor Ensalada Salad Fork, Fourchette À Servir Salade, Forchetta Servire, Salatgabel	7,42 €	10-50 / 10	240	2,5
P 4784	Pala Repostería Cake Server, Pelle À Tarte, Pala Torta, Tortenheber	7,61 €	10-50 / 10	240	2,5
Q 4783	Cazo Salsa Sauce Ladle, Cuillère À Sauce, Mestolino Salsa, Soßenkelle	7,61 €	10-50 / 10	170	2,7

REF.	Descripción	€	UE/MOQ	▶ mm	✂ mm
9817	24 Piezas 24 Pieces, Écrin 24 Pièces, Bauletto 24 Pz., 24 Stück	72,60 €	1-4 / 1		2,5

BARCELONA

INOX 18/10 / 3,5mm / Mirror

BARCELONA

INOX 18/10 / 3,5mm / Mirror



REF.	Descripción	€	UE/MOQ	▶ mm	✂ mm
A 0764	Cuchillo Chuletero Steak Knife, Couteau Steak, Coltello Bistecca, Steakmesser	3,19 €	12-120 / 12	223	
B 0268	Cuchillo Mesa Table Knife, Couteau Table, Coltello Tavola, Tafelmesser	3,19 €	12-120 / 12	221	
C 11913	Cuchara Mesa Table Spoon, Cuillère Table, Cucchiaio Tavola, Tafellöffel	2,89 €	12-120 / 12	200	3,5
D 11914	Tenedor Mesa Table Fork, Fourchette Table, Forchetta Tavola, Tafelgabel	2,89 €	12-120 / 12	200	3,5
E 5805	Pala Pescado Fish Knife, Couteau Poisson, Coltello Pesce, Fischmesser	2,90 €	12-120 / 12	205	2,5
F 5806	Tenedor Pescado Fish Fork, Fourchette Poisson, Forchetta Pesce, Fischgabel	2,90 €	12-120 / 12	190	2,5
G 5807	Cuchillo Postre Dessert Knife, Couteau Dessert, Coltello Frutta, Dessertmesser	2,98 €	12-120 / 12	202	
H 5808	Cuchara Postre Dessert Spoon, Cuillère Dessert, Cucchiaio Frutta, Dessertlöffel	2,90 €	12-120 / 12	183	2,5
I 5809	Tenedor Postre Dessert Fork, Fourchette Dessert, Forchetta Frutta, Dessertgabel	2,90 €	12-120 / 12	185	2,5
J 5814	Cuchillo Lunch Cake Knife, Couteau Gâteau, Coltello Dolce, Kuchenmesser	2,74 €	12-120 / 12	167	
K 5810	Tenedor Lunch Cake Fork, Fourchette Gâteau, Forchetta Dolce, Kuchengabel	1,75 €	12-120 / 12	140	2,5
L 5811	Cuchara Café Tea Spoon, Cuillère Café, Cucchiaio Caffé, Kaffeelöffel	1,75 €	12-120 / 12	140	2,5
M 5812	Cuchara Moka Coffee/Moka Spoon, Cuillère Moka, Cucchiaio Moka, Mokkalöffel	1,60 €	12-120 / 12	110	2,5
N 5815	Pala Mantequilla Butter Knife, Couteau Beurre, Coltello Burro, Buttermesser	2,79 €	12-120 / 12	165	2,5
O 3152	Cuchara Refresco Soda Spoon, Cuillère Mazagran, Cucchiaio Bibita, Longdrinklöffel	2,28 €	12-120 / 12	200	2,5
P 3153	Cuchara Consomé Consommé Spoon, Cuillère Consommé, Cucchiaio Zuppa, Bouillonlöffel	2,94 €	12-120 / 12	180	2,5
Q 0470	Cazo Sopa Soup Ladle, Louche À Potage, Mestolo, Suppenkelle	11,98 €	10-50 / 10	268	3
R 0471	Cuchara Ensalada Salad Spoon, Cuillère À Servir Salade, Cucchiaio Servire, Salatlöffel	8,18 €	10-50 / 10	270	3
S 0472	Tenedor Ensalada Salad Fork, Fourchette À Servir Salade, Forchetta Servire, Salatgabel	8,18 €	10-50 / 10	265	3
T 0473	Pala Lasaña Lasagna Server, Pelle À Lasagne, Pala Lasagna, Lasagneheber	7,57 €	10-50 / 10	235	3
U 0474	Cazo Salsa Sauce Ladle, Cuillère À Sauce, Mestolino Salsa, Soßenkelle	5,75 €	10-50 / 10	180	3

REF.	Descripción	€	UE/MOQ	▶ mm	✂ mm
5818	24 Piezas 24 pieces, écriin 24 pièces, bauiletto 24 pz., 24 stück	71,16 €	1-4 / 1		3



Estar siempre cerca, responder a todas las necesidades.

En Comas queremos estar presentes en cada mesa, en cada ocasión. Tanto en las situaciones especiales, como en las de cada día.

Estar cerca: esta es en esencia la función de nuestros cubiertos y de nuestra cultura de servicio al cliente.

Always close by, responding to all needs.

At Comas we want to be present at every table, on every occasion. Both in special and everyday situations.

Being close: this is essentially the function of our cutlery and our customer service culture

BCN SATIN

INOX Nickel Free 18% / 3mm / Satin

BCN SATIN

INOX Nickel Free 18% / 3mm / Satin

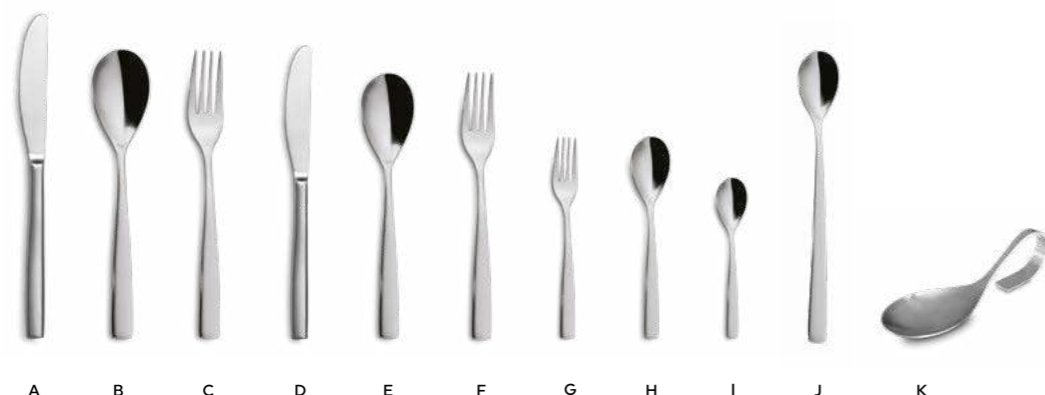

REF.	Descripción	€	UE/MOQ	▶ mm	✂ mm
A 6721	Cuchillo Mesa Table Knife, Couteau Table, Coltello Tavola, Tafelmesser	2,89 €	12-120 / 12	221	
B 6722	Cuchara Mesa Table Spoon, Cuillère Table, Cucchiaio Tavola, Tafellöffel	1,80 €	12-120 / 12	200	3
C 6723	Tenedor Mesa Table Fork, Fourchette Table, Forchetta Tavola, Tafelgabel	1,80 €	12-120 / 12	200	3
D 6724	Cuchillo Postre Dessert Knife, Couteau Dessert, Coltello Frutta, Dessertmesser	2,63 €	12-120 / 12	202	
E 6725	Cuchara Postre Dessert Spoon, Cuillère Dessert, Cucchiaio Frutta, Dessertlöffel	1,68 €	12-120 / 12	183	2,5
F 6726	Tenedor Postre Dessert Fork, Fourchette Dessert, Forchetta Frutta, Dessertgabel	1,68 €	12-120 / 12	185	2,5
G 6727	Tenedor Lunch Cake Fork, Fourchette Gâteau, Forchetta Dolce, Kuchengabel	1,37 €	12-120 / 12	140	2,5
H 6728	Cuchara Café Tea Spoon, Cuillère Café, Cucchiaio Caffé, Kaffeelöffel	1,37 €	12-120 / 12	140	2,5
I 6729	Cuchara Moka Moka Spoon, Cuillère Moka, Cucchiaio Moka, Mokkalöffel	1,33 €	12-120 / 12	110	2,5
J 8378	Cuchara Refresco Soda Spoon, Cuillère Mazagran, Cucchiaio Bibita, Longdrinklöffel	1,46 €	12-120 / 12	202	
K 8796	Cuchara Aperitivo Appetizer Spoon, Cuillère Apéritif, Cucchiaio Antipasto, Aperitif Löffel	1,97 €	12-120 / 12	132	3
1051	Blister 3 Cuchillo Mesa Blister 3 Table Knife, Blister 3 Couteau Table, Blister 3 Coltello Tavola, Blister 3 Tafelmesser	9,07 €	0-12 / 12		
1052	Blister 6 Cuchara Mesa Blister 6 Table Spoon, Blister 6 Cuillère Table, Blister 6 Cucchiaio Tavola, Blister 6 Tafellöffel	11,07 €	0-12 / 12		
1053	Blister 6 Tenedor Mesa Blister 6 Table Fork, Blister 6 Fourchette Table, Blister 6 Forchetta Tavola, Blister 6 Tafelgabel	11,07 €	0-12 / 12		
1055	Blister 6 Tenedor Lunch Blister 6 Cake Fork, Blister 6 Fourchette Gâteau, Blister 6 Forchetta Dolce, Blister 6 Kuchengabel	8,46 €	0-12 / 12		
1054	Blister 6 Cuchara Café Blister 6 Tea Spoon, Blister 6 Cuillère Café, Blister 6 Cucchiaio Caffé, Blister 6 Kaffeelöffel	8,46 €	0-12 / 12		
1056	Blister 6 Cuchara Moka Blister 6 Coffee/Moka Spoon, Blister 6 Cuillère Moka, Blister 6 Cucchiaio Moka, Blister 6 Mokkalöffel	8,15 €	0-12 / 12		



REF.	Descripción	€	UE/MOQ	▶ mm	✂ mm
A 6730	24 Piezas 24 Pieces, Écrin 24 Pièces, Bauletto 24 Pz., 24 Stück	50,09 €	1-4 / 1		3



BCN SATIN GOLD

INOX Nickel Free 18% / 3mm / Satin



REF.	Descripción	€	UE/MOQ	◀ mm	✂ mm
A 6096	Cuchillo Mesa Table Knife, Couteau Table, Coltello Tavola, Tafelmesser	4,26 €	12-120 / 12	221	
B 6097	Cuchara Mesa Table Spoon, Cuillère Table, Cucchiaio Tavola, Tafellöffel	3,61 €	12-120 / 12	200	3
C 6098	Tenedor Mesa Table Fork, Fourchette Table, Forchetta Tavola, Tafelgabel	3,61 €	12-120 / 12	200	3
D 11906	Pala Pescado Fish Knife, Couteau Poisson, Coltello Pesce, Fischmesser	2,82 €	12-120 / 12	206	2,5
E 11907	Tenedor Pescado Fish Fork, Fourchette Poisson, Forchetta Pesce, Fischgabel	2,82 €	12-120 / 12	187	2,5
F 6350	Cuchillo Postre Dessert Knife, Couteau Dessert, Coltello Frutta, Dessertmesser	3,87 €	12-120 / 12	202	
G 6351	Cuchara Postre Dessert Spoon, Cuillère Dessert, Cucchiaio Frutta, Dessertlöffel	3,28 €	12-120 / 12	183	2,5
H 6352	Tenedor Postre Dessert Fork, Fourchette Dessert, Forchetta Frutta, Dessertgabel	3,28 €	12-120 / 12	185	2,5
I 6099	Tenedor Lunch Cake Fork, Fourchette Gâteau, Forchetta Dolce, Kuchengabel	2,67 €	12-120 / 12	140	2,5
J 6100	Cuchara Café Tea Spoon, Cuillère Café, Cucchiaio Caffé, Kaffeelöffel	2,67 €	12-120 / 12	140	2,5
K 6101	Cuchara Moka Coffee/Moka Spoon, Cuillère Moka, Cucchiaio Moka, Mokkalöffel	2,45 €	12-120 / 12	110	2,5
L 7551	Cuchara Refresco Soda Spoon, Cuillère Mazagran, Cucchiaio Bibita, Longdrinklöffel	3,11 €	12-120 / 12	202	2,5
M 7902	Cuchara Ensalada Salad Spoon, Cuillère À Servir Salade, Cucchiaio Servire, Salatlöffel	5,33 €	10-50 / 10	270	3
N 7903	Tenedor Ensalada Salad Fork, Fourchette À Servir Salade, Forchetta Servire, Salatgabel	5,33 €	10-50 / 10	265	3
O 8797	Cuchara Aperitivo Appetizer Spoon, Cuillère Apéritif, Cucchiaio Antipasto, Aperitif Löffel	3,18 €	12-120 / 12	132	3
6324	24 Piezas 24 Pieces, Ecrin 24 Pièces, Bauletto 24 Pz., 24 Stück	84,77 €	1-4 / 1		3



BCN SATIN COPPER

INOX Nickel Free 18% / 3mm / Satin



REF.	Descripción	€	UE/MOQ	◀ mm	✂ mm
A 6108	Cuchillo Mesa Table Knife, Couteau Table, Coltello Tavola, Tafelmesser	4,26 €	12-120 / 12	221	
B 6109	Cuchara Mesa Table Spoon, Cuillère Table, Cucchiaio Tavola, Tafellöffel	3,61 €	12-120 / 12	200	3
C 6110	Tenedor Mesa Table Fork, Fourchette Table, Forchetta Tavola, Tafelgabel	3,61 €	12-120 / 12	200	3
D 11908	Pala Pescado Fish Knife, Couteau Poisson, Coltello Pesce, Fischmesser	2,82 €	12-120 / 12	206	2,5
E 11909	Tenedor Pescado Fish Fork, Fourchette Poisson, Forchetta Pesce, Fischmesser	2,82 €	12-120 / 12	187	2,5
F 6356	Cuchillo Postre Dessert Knife, Couteau Dessert, Coltello Frutta, Dessertmesser	3,87 €	12-120 / 12	202	
G 6357	Cuchara Postre Dessert Spoon, Cuillère Dessert, Cucchiaio Frutta, Dessertlöffel	3,28 €	12-120 / 12	183	2,5
H 6358	Tenedor Postre Dessert Fork, Fourchette Dessert, Forchetta Frutta, Dessertgabel	3,28 €	12-120 / 12	185	2,5
I 6111	Tenedor Lunch Cake Fork, Fourchette Gâteau, Forchetta Dolce, Kuchengabel	2,67 €	12-120 / 12	140	2,5
J 6112	Cuchara Café Tea Spoon, Cuillère Café, Cucchiaio Caffé, Kaffeelöffel	2,67 €	12-120 / 12	140	2,5
K 6113	Cuchara Moka Coffee/Moka Spoon, Cuillère Moka, Cucchiaio Moka, Mokkalöffel	2,45 €	12-120 / 12	110	2,5
L 7553	Cuchara Refresco Soda Spoon, Cuillère Mazagran, Cucchiaio Bibita, Longdrinklöffel	3,11 €	12-120 / 12	202	2,5
O 8799	Cuchara Aperitivo Appetizer Spoon, Cuillère Apéritif, Cucchiaio Antipasto, Aperitif Löffel	3,18 €	12-120 / 12	132	2,5
M 7965	Cuchara Ensalada Salad Spoon, Cuillère À Servir Salade, Cucchiaio Servire, Salatlöffel	5,33 €	10-50 / 10	270	3
N 7966	Tenedor Ensalada Salad Fork, Fourchette À Servir Salade, Forchetta Servire, Salatgabel	5,33 €	10-50 / 10	265	3
5314	Blister 3 Cuchillo Mesa Blister 3 Table Knife, Blister 3 Couteau Table, Blister 3 Coltello Tavola, Blister 3 Tafelmesser	13,05 €	0-12 / 12		3
5315	Blister 6 Cuchara Mesa Blister 6 Table Spoon, Blister 6 Cuillère Table, Blister 6 Cucchiaio Tavola, Blister 6 Tafellöffel	21,90 €	0-12 / 12		
5316	Blister 6 Tenedor Mesa Blister 6 Table Fork, Blister 6 Fourchette Table, Blister 6 Forchetta Tavola, Blister 6 Tafelgabel	21,90 €	0-12 / 12		
1057	Blister 6 Tenedor Lunch Blister 6 Cake Fork, Blister 6 Fourchette Gâteau, Blister 6 Forchetta Dolce, Blister 6 Kuchengabel	16,25 €	0-12 / 12		
5317	Blister 6 Cuchara Café Blister 6 Tea Spoon, Blister 6 Cuillère Café, Blister 6 Cucchiaio Caffé, Blister 6 Kaffeelöffel	16,25 €	0-12 / 12		
1058	Blister 6 Cuchara Moka Blister 6 Coffee/Moka Spoon, Blister 6 Cuillère Moka, Blister 6 Cucchiaio Moka, Blister 6 Mokkalöffel	14,95 €	0-12 / 12		
6325	24 Piezas 24 Pieces, Ecrin 24 Pièces, Bauletto 24 Pz., 24 Stück	86,50 €	1-4 / 1		



BCN SATIN CHAMPAGNE

INOX Nickel Free 18% / 3mm / Satin

BCN SATIN BLACK

INOX Nickel Free 18% / 3mm / Satin

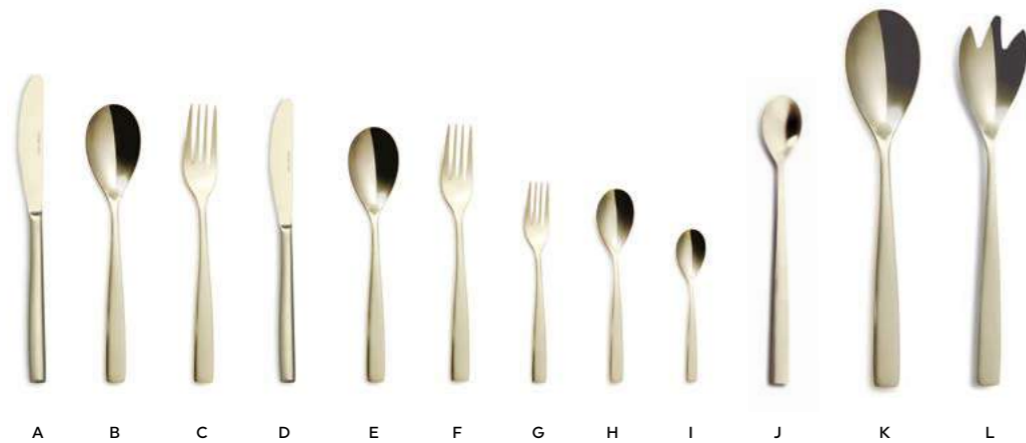

REF.	Descripción	€	UE/MOQ	▶ mm	✂ mm
A 6711	Cuchillo Mesa Table Knife, Couteau Table, Coltello Tavola, Tafelmesser	4,26 €	12-120 / 12	221	
B 6712	Cuchara Mesa Table Spoon, Cuillère Table, Cucchiaio Tavola, Tafellöffel	3,61 €	12-120 / 12	200	3
C 6713	Tenedor Mesa Table Fork, Fourchette Table, Forchetta Tavola, Tafelgabel	3,61 €	12-120 / 12	200	3
D 6714	Cuchillo Postre Dessert Knife, Couteau Dessert, Coltello Frutta, Dessertmesser	3,87 €	12-120 / 12	202	
E 6715	Cuchara Postre Dessert Spoon, Cuillère Dessert, Cucchiaio Frutta, Dessertlöffel	3,28 €	12-120 / 12	183	2,5
F 6716	Tenedor Postre Dessert Fork, Fourchette Dessert, Forchetta Frutta, Dessertgabel	3,28 €	12-120 / 12	185	2,5
G 6717	Tenedor Lunch Cake Fork, Fourchette Gâteau, Forchetta Dolce, Kuchengabel	2,67 €	12-120 / 12	140	2,5
H 6718	Cuchara Cafe Tea Spoon, Cuillère Café, Cucchiaio Caffé, Kaffeelöffel	2,67 €	12-120 / 12	140	2,5
I 6719	Cuchara Moka Coffee/Moka Spoon, Cuillère Moka, Cucchiaio Moka, Mokkalöffel	2,45 €	12-120 / 12	110	2,5
J 7899	Cuchara Refresco Soda Spoon, Cuillère Mazagran, Cucchiaio Bibita, Longdrinklöffel	3,11 €	12-120 / 12	202	2,5
K 7900	Cuchara Ensalada Salad Spoon, Cuillère À Servir Salade, Cucchiaio Servire, Salatlöffel	5,33 €	10-50 / 10	270	3
L 7901	Tenedor Ensalada Salad Fork, Fourchette À Servir Salade, Forchetta Servire, Salatgabel	5,33 €	10-50 / 10	265	3
5310	Blister 3 Cuchillo Mesa Blister 3 Table Knife, Blister 3 Couteau Table, Blister 3 Coltello Tavola, Blister 3 Tafelmesser	13,05 €	0-12 / 12		
5312	Blister 6 Cuchara Mesa Blister 6 Table Spoon, Blister 6 Cuillère Table, Blister 6 Cucchiaio Tavola, Blister 6 Tafellöffel	21,90 €	0-12 / 12		
5311	Blister 6 Tenedor Mesa Blister 6 Table Fork, Blister 6 Fourchette Table, Blister 6 Forchetta Tavola, Blister 6 Tafelgabel	21,90 €	0-12 / 12		
1059	Blister 6 Tenedor Lunch Blister 6 Cake Fork, Blister 6 Fourchette Gâteau, Blister 6 Forchetta Dolce, Blister 6 Kuchengabel	16,25 €	0-12 / 12		
5313	Blister 6 Cuchara Cafe Blister 6 Tea Spoon, Blister 6 Cuillère Café, Blister 6 Cucchiaio Caffé, Blister 6 Kaffeelöffel	16,25 €	0-12 / 12		
1060	Blister 6 Cuchara Moka Blister 6 Coffee/Moka Spoon, Blister 6 Cuillère Moka, Blister 6 Cucchiaio Moka, Blister 6 Mokkalöffel	14,95 €	0-12 / 12		
6720	24 Piezas 24 Pieces, Écrin 24 Pièces, Bauletto 24 Pz., 24 Stück	86,50 €	1-4 / 1		3

REF.	Descripción	€	UE/MOQ	▶ mm	✂ mm
A 6102	Cuchillo Mesa Table Knife, Couteau Table, Coltello Tavola, Tafelmesser	4,26 €	12-120 / 12	221	
B 6103	Cuchara Mesa Table Spoon, Cuillère Table, Cucchiaio Tavola, Tafellöffel	3,61 €	12-120 / 12	200	3
C 6104	Tenedor Mesa Table Fork, Fourchette Table, Forchetta Tavola, Tafelgabel	3,61 €	12-120 / 12	200	3
D 11910	Pala Pescado Table Fork, Fourchette Table, Forchetta Tavola, Tafelgabel	2,82 €	12-120 / 12	206	2,5
E 11911	Tenedor Pescado Fish Knife, Couteau Poisson, Coltello Pesce, Fischmesser	2,82 €	12-120 / 12	187	2,5
F 6353	Cuchillo Postre Dessert Knife, Couteau Dessert, Coltello Frutta, Dessertmesser	3,87 €	12-120 / 12	202	2,5
G 6354	Cuchara Postre Dessert Spoon, Cuillère Dessert, Cucchiaio Frutta, Dessertlöffel	3,28 €	12-120 / 12	183	2,5
H 6355	Tenedor Postre Dessert Fork, Fourchette Dessert, Forchetta Frutta, Dessertgabel	3,28 €	12-120 / 12	185	2,5
I 6105	Tenedor Lunch Cake Fork, Fourchette Gâteau, Forchetta Dolce, Kuchengabel	2,67 €	12-120 / 12	140	2,5
J 6106	Cuchara Café Tea Spoon, Cuillère Café, Cucchiaio Caffé, Kaffeelöffel	2,67 €	12-120 / 12	140	2,5
K 6107	Cuchara Moka Coffee/Moka Spoon, Cuillère Moka, Cucchiaio Moka, Mokkalöffel	2,45 €	12-120 / 12	110	2,5
L 7552	Cuchara Refresco Soda Spoon, Cuillère Mazagran, Cucchiaio Bibita, Longdrinklöffel	3,11 €	12-120 / 12	202	3
O 8798	Cuchara Aperitivo Appetizer Spoon, Cuillère Apéritif, Cucchiaio Antipasto, Aperitif Löffel	3,19 €	12-120 / 12	132	3
M 7963	Cuchara Ensalada Salad Spoon, Cuillère À Servir Salade, Cucchiaio Servire, Salatlöffel	5,33 €	10-50 / 10	270	3
N 7964	Tenedor Ensalada Salad Fork, Fourchette À Servir Salade, Forchetta Servire, Salatgabel	5,33 €	10-50 / 10	265	
5318	Blister 3 Cuchillo Mesa Blister 3 Table Knife, Blister 3 Couteau Table, Blister 3 Coltello Tavola, Blister 3 Tafelmesser	13,05 €	0-12 / 12		
5320	Blister 6 Cuchara Mesa Blister 6 Table Spoon, Blister 6 Cuillère Table, Blister 6 Cucchiaio Tavola, Blister 6 Tafellöffel	21,90 €	0-12 / 12		
5319	Blister 6 Tenedor Mesa Blister 6 Table Fork, Blister 6 Fourchette Table, Blister 6 Forchetta Tavola, Blister 6 Tafelgabel	21,90 €	0-12 / 12		
1061	Blister 6 Tenedor Lunch Blister 6 Cake Fork, Blister 6 Fourchette Gâteau, Blister 6 Forchetta Dolce, Blister 6 Kuchengabel	16,25 €	0-12 / 12		
5321	Blister 6 Cuchara Cafe Blister 6 Tea Spoon, Blister 6 Cuillère Café, Blister 6 Cucchiaio Caffé, Blister 6 Kaffeelöffel	16,25 €	0-12 / 12		
1062	Blister 6 Cuchara Moka Blister 6 Coffee/Moka Spoon, Blister 6 Cuillère Moka, Blister 6 Cucchiaio Moka, Blister 6 Mokkalöffel	14,95 €	0-12 / 12		
6323	24 Piezas 24 Pieces, Écrin 24 Pièces, Bauletto 24 Pz., 24 Stück	86,50 €	1-4 / 1		3

MALVARROSA

INOX Nickel Free 18% / 4mm / Mirror



OSLO ECO

INOX Nickel Free 18% / 7mm / Mirror / FORGED



REF.	Descripción	€	UE/MOQ	▶ mm	✂ mm
A 6573	Cuchillo Mesa Table Knife, Couteau Table, Coltello Tavola, Tafelmesser	2,87 €	12-120 / 12	225	
B 6574	Cuchara Mesa Table Spoon, Cuillère Table, Cucchiaio Tavola, Tafellöffel	2,17 €	12-120 / 12	206	4
C 6575	Tenedor Mesa Table Fork, Fourchette Table, Forchetta Tavola, Tafelgabel	2,17 €	12-120 / 12	206	4
D 6576	Cuchillo Postre Dessert Knife, Couteau Dessert, Coltello Frutta, Dessertmesser	2,55 €	12-120 / 12	203	
E 6577	Cuchara Postre Dessert Spoon, Cuillère Dessert, Cucchiaio Frutta, Dessertlöffel	1,90 €	12-120 / 12	185	3,5
F 6578	Tenedor Postre Dessert Fork, Fourchette Dessert, Forchetta Frutta, Dessertgabel	1,90 €	12-120 / 12	185	3,5
G 6579	Cuchara Café Tea Spoon, Cuillère Café, Cucchiaio Caffé, Kaffeelöffel	1,25 €	12-120 / 12	140	3
H 6580	Tenedor Lunch Cake Fork, Fourchette Gâteau, Forchetta Dolce, Kuchengabel	1,25 €	12-120 / 12	140	3
I 6581	Cuchara Moka Coffee/Moka Spoon, Cuillère Moka, Cucchiaio Moka, Mokkalöffel	1,14 €	12-120 / 12	115	3
6582	Mazo 2 Cuchillo Mesa Film 2 Table Knife, Film 2 Couteau Table, Film 2 Coltello Tavola, Film 2 Tafelmesser	7,28 €	0-48 / 48	225	
6583	Mazo 3 Cuchara Mesa Film 3 Table Spoon, Film 3 Cuillère Table, Film 3 Cucchiaio Tavola, Film 3 Tafellöffel	7,28 €	0-48 / 48	206	4
6584	Mazo 3 Tenedor Mesa Film 3 Table Fork, Film 3 Fourchette Table, Film 3 Forchetta Tavola, Film 3 Tafelgabel	7,28 €	0-48 / 48	206	4
6585	Mazo 6 Tenedor Lunch Film 6 Cake Fork, Film 6 Fourchette Gâteau, Film 6 Forchetta Dolce, Film 6 Kuchengabel	7,28 €	0-48 / 48	140	3
6586	Mazo 6 Cuchara Café Film 6 Tea Spoon, Film 6 Cuillère Café, Film 6 Cucchiaio Caffé, Film 6 Kaffeelöffel	7,28 €	0-48 / 48	140	3
6587	Mazo 6 Cuchara Moka Film 6 Coffee/Moka Spoon, Film 6 Cuillère Moka, Film 6 Cucchiaio Moka, Film 6 Mokkalöffel	7,28 €	0-48 / 48	115	3
6588	24 Piezas 24 Pieces, Écrin 24 Pièces, Bauletto 24 Pz., 24 Stück	54,34 €	1-4 / 1		4

REF.	Descripción	€	UE/MOQ	▶ mm	✂ mm
A 5474	Cuchillo Mesa Table Knife, Couteau Table, Coltello Tavola, Tafelmesser	3,31 €	12-120 / 12	235	
B 1336	Cuchara Mesa Table Spoon, Cuillère Table, Cucchiaio Tavola, Tafellöffel	3,44 €	12-120 / 12	208	7
C 1337	Tenedor Mesa Table Fork, Fourchette Table, Forchetta Tavola, Tafelgabel	3,44 €	12-120 / 12	208	7
D 2568	Tenedor Lunch Cake Fork, Fourchette Gâteau, Forchetta Dolce, Kuchengabel	2,53 €	12-120 / 12	150	5,5
E 1338	Cuchara Café Tea Spoon, Cuillère Café, Cucchiaio Caffé, Kaffeelöffel	2,52 €	12-120 / 12	145	5,5
F 2569	Cuchara Moka Coffee/Moka Spoon, Cuillère Moka, Cucchiaio Moka, Mokkalöffel	2,17 €	12-120 / 12	120	4,5
0298	24 Piezas 24 Pieces, Écrin 24 Pièces, Bauletto 24 Pz., 24 Stück	90,33 €	1-4 / 1		7

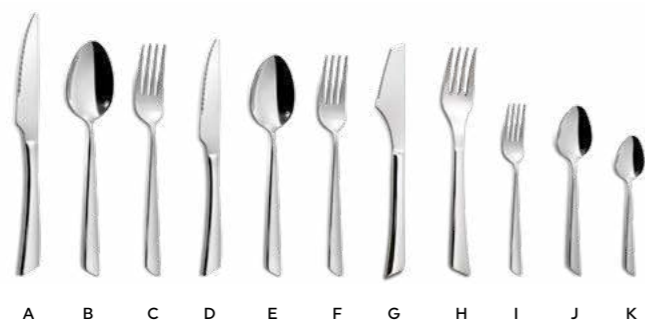

REF.	Descripción	€	UE/MOQ	▶ mm	✂ mm
A 3197	Cuchillo Chuletero Steak Knife, Couteau Steak, Coltello Bistecca, Steakmesser	2,76 €	12-120 / 12	233	
B 3198	Cuchara Mesa Table Spoon, Cuillère Table, Cucchiaio Tavola, Tafellöffel	2,03 €	12-120 / 12	208	4
C 3199	Tenedor Mesa Table Fork, Fourchette Table, Forchetta Tavola, Tafelgabel	2,03 €	12-120 / 12	208	4
D 3200	Cuchillo Postre Dessert Knife, Couteau Dessert, Coltello Frutta, Dessertmesser	2,73 €	12-120 / 12	210	
E 3201	Cuchara Postre Dessert Spoon, Cuillère Dessert, Cucchiaio Frutta, Dessertlöffel	1,97 €	12-120 / 12	195	4
F 3202	Tenedor Postre Dessert Fork, Fourchette Dessert, Forchetta Frutta, Dessertgabel	1,97 €	12-120 / 12	195	4
G 3263	Cuchillo Pizza Napoli Pizza Knife, Couteau Pizza, Coltello Pizza, Pizza Tafelmesser	2,77 €	12-120 / 12	205	
H 3264	Tenedor Pizza Napoli Pizza Fork, Fourchette Pizza, Forchetta Pizza, Pizza Gabel	2,12 €	12-120 / 12	202	4
I 3203	Tenedor Lunch Cake Fork, Fourchette Gâteau, Forchetta Dolce, Kuchengabel	1,30 €	12-120 / 12	152	3
J 3204	Cuchara Café Tea Spoon, Cuillère Café, Cucchiaio Caffé, Kaffeelöffel	1,30 €	12-120 / 12	150	3
K 3205	Cuchara Moka Coffee/Moka Spoon, Cuillère Moka, Cucchiaio Moka, Mokkalöffel	1,24 €	12-120 / 12	125	3
3216	Mazo 2 Cuchillo Chuletero Film 2 Steak Knife, Film 2 Couteau Steak, Film 2 Coltello Bistecca, Film 2 Steakmesser	7,48 €	0-48 / 48	233	
3217	Mazo 3 Cuchara Mesa Film 3 Table Spoon, Film 3 Cuillère Table, Film 3 Cucchiaio Tavola, Film 3 Tafellöffel	7,48 €	0-48 / 48	208	4
3218	Mazo 3 Tenedor Mesa Film 3 Table Fork, Film 3 Fourchette Table, Film 3 Forchetta Tavola, Film 3 Tafelgabel	7,48 €	0-48 / 48	208	4
3219	Mazo 2 Cuchillo Postre Film 2 Dessert Knife, Film 2 Couteau Dessert, Film 2 Coltello Frutta, Film 2 Dessertmesser	7,48 €	0-48 / 48	210	
3220	Mazo 3 Cuchara Postre Film 3 Dessert Spoon, Film 3 Cuillère Dessert, Film 3 Cucchiaio Frutta, Film 3 Dessertlöffel	7,48 €	0-48 / 48	195	4
3221	Mazo 3 Tenedor Postre Film 3 Dessert Fork, Film 3 Fourchette Dessert, Film 3 Forchetta Frutta, Film 3 Dessertgabel	7,48 €	0-48 / 48	195	4
3222	Mazo 6 Tenedor Lunch Film 6 Cake Fork, Film 6 Fourchette Gâteau, Film 6 Forchetta Dolce, Film 6 Kuchengabel	7,48 €	0-48 / 48	152	3
3223	Mazo 6 Cuchara Café Film 6 Tea Spoon, Film 6 Cuillère Café, Film 6 Cucchiaio Caffé, Film 6 Kaffeelöffel	7,48 €	0-48 / 48	150	3
3224	Mazo 6 Cuchara Moka Film 6 Coffee/Moka Spoon, Film 6 Cuillère Moka, Film 6 Cucchiaio Moka, Film 6 Mokkalöffel	7,48 €	0-48 / 48	125	3
3265	Blister 3 Cuchillo Pizza Napoli	9,21 €	0-24 / 24	205	
3266	Blister Cuchillo + Tenedor Pizza Napoli	5,42 €	0-24 / 24	205	



REF.	Descripción	€	UE/MOQ	▶ mm	✂ mm
3227	24 Piezas 24 pieces, écrin 24 pièces, bauletto 24 pz., 24 stück	50,16 €	1-4 / 1		4

CANADA

INOX Nickel Free 18% / 4mm / Mirror



REF.	Descripción	€	UE/MOQ	▶ mm	✂ mm
A 6540	Cuchillo Mesa Table Knife, Couteau Table, Coltello Tavola, Tafelmesser	2,65 €	12-120 / 12		
B 6541	Cuchara Mesa Table Spoon, Cuillère Table, Cucchiario Tavola, Tafellöffel	1,88 €	12-120 / 12	233	4
C 6542	Tenedor Mesa Table Fork, Fourchette Table, Forchetta Tavola, Tafelgabel	1,88 €	12-120 / 12	206	4
D 6543	Cuchillo Postre Dessert Knife, Couteau Dessert, Coltello Frutta, Dessertmesser	2,49 €	12-120 / 12	204	
E 6544	Cuchara Postre Dessert Spoon, Cuillère Dessert, Cucchiario Frutta, Dessertlöffel	1,56 €	12-120 / 12	209	3
F 6545	Tenedor Postre Dessert Fork, Fourchette Dessert, Forchetta Frutta, Dessertgabel	1,56 €	12-120 / 12	185	3
G 6547	Cuchara Café Tea Spoon, Cuillère Café, Cucchiario Caffé, Kaffeelöffel	1,10 €	12-120 / 12	184	3
H 6548	Tenedor Lunch Film ó Cake Fork, Film ó Fourchette Gâteau, Film ó Forchetta Dolce, Film ó Kuchengabel	1,10 €	12-120 / 12	145	3
I 6549	Cuchara Moka Film ó Coffee/Moka Spoon, Film ó Cuillère Moka, Film ó Cucchiario Moka, Film ó Mokkalöffel	1,00 €	12-120 / 12	150	2
6550	Mazo ó Cuchillo Mesa Film ó Table Knife, Film ó Couteau Table, Film ó Coltello Tavola, Film ó Tafelmesser	7,28 €	0-48 / 48	115	
6551	Mazo ó Cuchara Mesa Film ó Table Spoon, Film ó Cuillère Table, Film ó Cucchiario Tavola, Film ó Tafellöffel	7,28 €	0-48 / 48	233	4
6552	Mazo ó Tenedor Mesa Film ó Table Fork, Film ó Fourchette Table, Film ó Forchetta Tavola, Film ó Tafelgabel	7,28 €	0-48 / 48	206	4
6553	Mazo ó Tenedor Lunch Film ó Cake Fork, Film ó Fourchette Gâteau, Film ó Forchetta Dolce, Film ó Kuchengabel	7,28 €	0-48 / 48	204	3
6554	Mazo ó Cuchara Café Film ó Tea Spoon, Film ó Cuillère Café, Film ó Cucchiario Caffé, Film ó Kaffeelöffel	7,28 €	0-48 / 48	150	3
6555	Mazo ó Cuchara Moka Film ó Coffee/Moka Spoon, Film ó Cuillère Moka, Film ó Cucchiario Moka, Film ó Mokkalöffel	7,28 €	0-48 / 48	145	2
6556	24 Piezas 24 Pieces, Écrin 24 Pièces, Bauletto 24 Pz., 24 Stück	47,99 €	1-4 / 1		3

CANADA

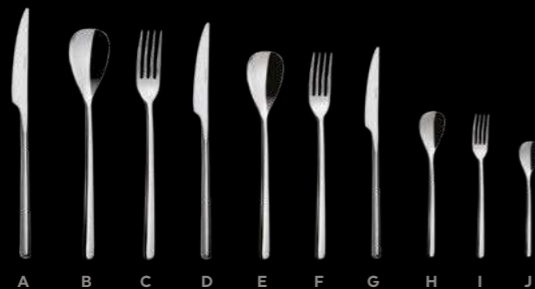

CANADA VINTAGE

INOX Nickel Free 18% / 4mm / Vintage

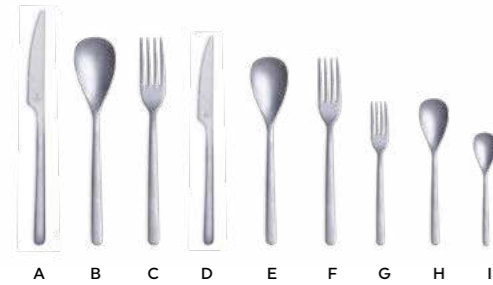

CANADA VINTAGE GOLD

INOX Nickel Free 18% / 4mm / Vintage

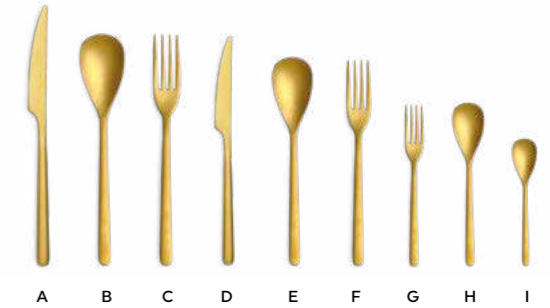

REF.	Descripción	€	UE/MOQ	▶ mm	✂ mm
A 1241	Cuchillo Mesa Table Knife, Couteau Table, Coltello Tavola, Tafelmesser	3,00 €	12-120 / 12	233	
B 1242	Cuchara Mesa Table Spoon, Cuillère Table, Cucchiaino Tavola, Tafellöffel	2,50 €	12-120 / 12	206	4
C 1243	Tenedor Mesa Table Fork, Fourchette Table, Forchetta Tavola, Tafelgabel	2,50 €	12-120 / 12	204	4
D 1244	Cuchillo Postre Dessert Knife, Couteau Dessert, Coltello Frutta, Dessertmesser	2,88 €	12-120 / 12	209	
E 1245	Cuchara Postre Dessert Spoon, Cuillère Dessert, Cucchiaino Frutta, Dessertlöffel	2,02 €	12-120 / 12	185	3
F 1246	Tenedor Postre Dessert Fork, Fourchette Dessert, Forchetta Frutta, Dessertgabel	2,02 €	12-120 / 12	184	3
G 1247	Tenedor Lunch Cake Fork, Fourchette Gâteau, Forchetta Dolce, Kuchengabel	1,69 €	12-120 / 12	145	3
H 1248	Cuchara Café Tea Spoon, Cuillère Café, Cucchiaino Caffé, Kaffeelöffel	1,69 €	12-120 / 12	150	3
I 1249	Cuchara Moka Coffee/Moka Spoon, Cuillère Moka, Cucchiaino Moka, Mokkalöffel	1,48 €	12-120 / 12	115	2
1228	24 Piezas 24 Pieces, Écrin 24 Pièces, Bauletto 24 Pz., 24 Stück	61,79 €	1-4 / 1		4



REF.	Descripción	€	UE/MOQ	▶ mm	✂ mm
A 1252	Cuchillo Mesa Table Knife, Couteau Table, Coltello Tavola, Tafelmesser	4,61 €	12-120 / 12	233	
B 1253	Cuchara Mesa Table Spoon, Cuillère Table, Cucchiaino Tavola, Tafellöffel	4,11 €	12-120 / 12	206	4
C 1254	Tenedor Mesa Table Fork, Fourchette Table, Forchetta Tavola, Tafelgabel	4,11 €	12-120 / 12	204	4
D 1255	Cuchillo Postre Dessert Knife, Couteau Dessert, Coltello Frutta, Dessertmesser	4,50 €	12-120 / 12	209	
E 1256	Cuchara Postre Dessert Spoon, Cuillère Dessert, Cucchiaino Frutta, Dessertlöffel	3,62 €	12-120 / 12	185	3
F 1257	Tenedor Postre Dessert Fork, Fourchette Dessert, Forchetta Frutta, Dessertgabel	3,62 €	12-120 / 12	184	3
G 1258	Tenedor Lunch Cake Fork, Fourchette Gâteau, Forchetta Dolce, Kuchengabel	3,30 €	12-120 / 12	145	3
H 1259	Cuchara Café Tea Spoon, Cuillère Café, Cucchiaino Caffé, Kaffeelöffel	3,30 €	12-120 / 12	150	3
I 1260	Cuchara Moka Coffee/Moka Spoon, Cuillère Moka, Cucchiaino Moka, Mokkalöffel	3,08 €	12-120 / 12	115	2
1229	24 Piezas 24 Pieces, Écrin 24 Pièces, Bauletto 24 Pz., 24 Stück	105,85 €	1-4 / 1		4



CANADA VINTAGE CHAMPAGNE

INOX Nickel Free 18% / 4mm / Vintage



CANADA POLVO DE LUNA

INOX Nickel Free 18% / 4mm / Shotblasting



REF.	Descripción	€	UE/MOQ	▶ mm	✂ mm
A 11645	Cuchillo Mesa Table Knife, Couteau Table, Coltello Tavola, Tafelmesser	4,66 €	12-120 / 12	233	
B 11646	Cuchara Mesa Table Spoon, Cuillère Table, Cucchiaio Tavola, Tafellöffel	4,16 €	12-120 / 12	206	4
C 11647	Tenedor Mesa Table Fork, Fourchette Table, Forchetta Tavola, Tafelgabel	4,16 €	12-120 / 12	204	4
D 11648	Cuchillo Postre Dessert Knife, Couteau Dessert, Coltello Frutta, Dessertmesser	4,54 €	12-120 / 12	209	
E 11649	Cuchara Postre Dessert Spoon, Cuillère Dessert, Cucchiaio Frutta, Dessertlöffel	3,66 €	12-120 / 12	185	3
F 11650	Tenedor Postre Dessert Fork, Fourchette Dessert, Forchetta Frutta, Dessertgabel	3,66 €	12-120 / 12	184	3
G 11651	Tenedor Lunch Cake Fork, Fourchette Gâteau, Forchetta Dolce, Kuchengabel	3,33 €	12-120 / 12	145	3
H 11652	Cuchara Café Tea Spoon, Cuillère Café, Cucchiaio Caffé, Kaffeelöffel	3,33 €	12-120 / 12	150	3
I 11653	Cuchara Moka Coffee/Moka Spoon, Cuillère Moka, Cucchiaio Moka, Mokkalöffel	3,11 €	12-120 / 12	115	2
11654	24 Piezas 24 Pieces, Écrin 24 Pièces, Bauletto 24 Pz., 24 Stück	106,94 €	1-4 / 1		4



REF.	Descripción	€	UE/MOQ	▶ mm	✂ mm
A 5073	Cuchillo Mesa Table Knife, Couteau Table, Coltello Tavola, Tafelmesser	3,39 €	12-120 / 12	233	
B 5074	Cuchara Mesa Table Spoon, Cuillère Table, Cucchiaio Tavola, Tafellöffel	2,86 €	12-120 / 12	206	4
C 5075	Tenedor Mesa Table Fork, Fourchette Table, Forchetta Tavola, Tafelgabel	2,86 €	12-120 / 12	204	4
D 5076	Cuchillo Postre Dessert Knife, Couteau Dessert, Coltello Frutta, Dessertmesser	3,22 €	12-120 / 12	209	
E 5077	Cuchara Postre Dessert Spoon, Cuillère Dessert, Cucchiaio Frutta, Dessertlöffel	2,37 €	12-120 / 12	185	3
F 5078	Tenedor Postre Dessert Fork, Fourchette Dessert, Forchetta Frutta, Dessertgabel	2,37 €	12-120 / 12	184	3
G 5079	Tenedor Lunch Cake Fork, Fourchette Gâteau, Forchetta Dolce, Kuchengabel	2,01 €	12-120 / 12	145	3
H 5080	Cuchara Café Tea Spoon, Cuillère Café, Cucchiaio Caffé, Kaffeelöffel	2,01 €	12-120 / 12	150	3
I 5081	Cuchara Moka Coffee/Moka Spoon, Cuillère Moka, Cucchiaio Moka, Mokkalöffel	1,82 €	12-120 / 12	115	2
5083	24 Piezas 24 Pieces, Écrin 24 Pièces, Bauletto 24 Pz., 24 Stück	68,94 €	1-4 / 1		4



CANADA VINTAGE BLACK

INOX Nickel Free 18% / 4mm / Vintage

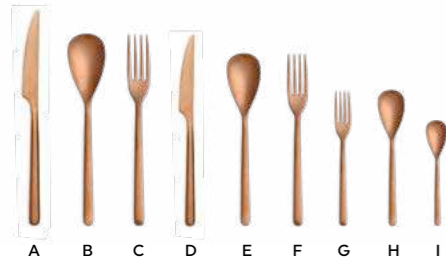

CANADA VINTAGE BLACK

INOX Nickel Free 18% / 4mm / Vintage



REF.	Descripción	€	UE/MOQ	▶ mm	✂ mm
A 1270	Cuchillo Mesa Table Knife, Couteau Table, Coltello Tavola, Tafelmesser	4,61 €	12-120 / 12	233	
B 1271	Cuchara Mesa Table Spoon, Cuillère Table, Cucchiaio Tavola, Tafellöffel	4,11 €	12-120 / 12	206	4
C 1272	Tenedor Mesa Table Fork, Fourchette Table, Forchetta Tavola, Tafelgabel	4,11 €	12-120 / 12	204	4
D 1273	Cuchillo Postre Dessert Knife, Couteau Dessert, Coltello Frutta, Dessertmesser	4,50 €	12-120 / 12	209	
E 1274	Cuchara Postre Dessert Spoon, Cuillère Dessert, Cucchiaio Frutta, Dessertlöffel	3,62 €	12-120 / 12	185	3
F 1275	Tenedor Postre Dessert Fork, Fourchette Dessert, Forchetta Frutta, Dessertgabel	3,62 €	12-120 / 12	184	3
G 1276	Tenedor Lunch Cake Fork, Fourchette Gâteau, Forchetta Dolce, Kuchengabel	3,30 €	12-120 / 12	145	3
H 1277	Cuchara Café Tea Spoon, Cuillère Café, Cucchiaio Caffé, Kaffeelöffel	3,30 €	12-120 / 12	150	3
I 1278	Cuchara Moka Coffee/Moka Spoon, Cuillère Moka, Cucchiaio Moka, Mokkalöffel	3,08 €	12-120 / 12	115	2
1231	24 Piezas 24 Pieces, Écrin 24 Pièces, Bauletto 24 Pz., 24 Stück	105,85 €	1-4 / 1		4



REF.	Descripción	€	UE/MOQ	▶ mm	✂ mm
A 1261	Cuchillo Mesa Table Knife, Couteau Table, Coltello Tavola, Tafelmesser	4,61 €	12-120 / 12	233	
B 1262	Cuchara Mesa Table Spoon, Cuillère Table, Cucchiaio Tavola, Tafellöffel	4,11 €	12-120 / 12	206	4
C 1263	Tenedor Mesa Table Fork, Fourchette Table, Forchetta Tavola, Tafelgabel	4,11 €	12-120 / 12	204	4
D 1264	Cuchillo Postre Dessert Knife, Couteau Dessert, Coltello Frutta, Dessertmesser	4,50 €	12-120 / 12	209	
E 1265	Cuchara Postre Dessert Spoon, Cuillère Dessert, Cucchiaio Frutta, Dessertlöffel	3,62 €	12-120 / 12	185	3
F 1266	Tenedor Postre Dessert Fork, Fourchette Dessert, Forchetta Frutta, Dessertgabel	3,62 €	12-120 / 12	184	3
G 1267	Tenedor Lunch Cake Fork, Fourchette Gâteau, Forchetta Dolce, Kuchengabel	3,30 €	12-120 / 12	145	3
H 1268	Cuchara Café Tea Spoon, Cuillère Café, Cucchiaio Caffé, Kaffeelöffel	3,30 €	12-120 / 12	150	3
I 1269	Cuchara Moka Coffee/Moka Spoon, Cuillère Moka, Cucchiaio Moka, Mokkalöffel	3,08 €	12-120 / 12	115	2
1230	24 Piezas 24 Pieces, Écrin 24 Pièces, Bauletto 24 Pz., 24 Stück	105,85 €	1-4 / 1		4





FINGER FOOD



136

FINGER FOOD

INOX Nickel Free 18% / 4mm / Vintage



MINI CUBIERTOS PARA EXPERIENCIAS DE GRAN SABOR MINI CUTLERY FOR GREAT TASTING EXPERIENCES

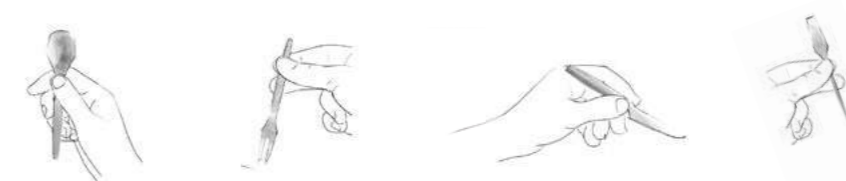

Cubertería de diseño propio creada para comidas de servicio rápido.
Cutlery of our own design created for quick service meals.

REF.	Descripción	€	UE/MOQ	▶ mm	✂ mm
A 8784	Cuchillo Lunch Cake Knife, Couteau Gâteau, Coltello Dolce, Kuchenmesser	2,15 €	12-120 / 12	140	6
B 8786	Cuchara Café Tea Spoon, Cuillère Café, Cucchiario Caffé, Kaffeelöffel	0,96 €	12-120 / 12	130	2
C 8785	Tenedor Lunch Cake Fork, Fourchette Gâteau, Forchetta Dolce, Kuchengabel	0,96 €	12-120 / 12	130	2
D 8787	Pincho Tapas Cocktail Stick, Stick À Cocktail, Spiedo, Spieß	0,96 €	12-120 / 12	137	2
8795	Pack 4 Pcs Pack 4 Pièces, Pack 4 Pièces, Pack 4 Pz., 4 Pack	4,79 €	24-96 / 24		2

INOX
STAINLESS
STEEL
430



1001 Black

INOX Nickel Free 18% / 1mm / PVD

REF.	Descripción	€	UE/MOQ	▶ mm	✂ mm
A 1746	Tenedor Mini Lunch Mini Cake Fork, Fourchette Minigâteau, Forchetta Mini Dolce, Kuchengabel Klein	1,00 €	12-120 / 120	110	1
B 1747	Cuchara Moka Coffee/Moka Spoon, Cuillère Moka, Cucchiario Moka, Mokkalöffel	1,00 €	12-120 / 120	110	1

137

SANTORINI

INOX Nickel Free 18% / 3,5mm / Mirror

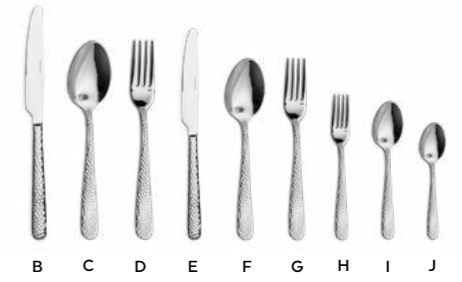

A



REF.	Descripción	€	UE/MOQ	▶ mm	✂ mm
------	-------------	---	--------	------	------

A	11584 Cuchillo Chuletero Steak Knife, Couteau Steak, Coltello Bistecca, Steakmesser	3,18 €	12-120 / 12	232	
B	10642 Cuchillo Mesa Table Knife, Couteau Table, Coltello Tavola, Tafelmesser	3,19 €	12-120 / 12	235	
C	10643 Cuchara Mesa Table Spoon, Cuillère Table, Cucchiaio Tavola, Tafellöffel	1,98 €	12-120 / 12	200	3,5
D	10644 Tenedor Mesa Table Fork, Fourchette Table, Forchetta Tavola, Tafelgabel	1,98 €	12-120 / 12	200	3,5
E	10832 Cuchillo Postre Dessert Knife, Couteau Dessert, Coltello Frutta, Dessertmesser	2,73 €	12-120 / 12	210	
F	10833 Cuchara Postre Dessert Spoon, Cuillère Dessert, Cucchiaio Frutta, Dessertlöffel	1,43 €	12-120 / 12	180	
G	10834 Tenedor Postre Dessert Fork, Fourchette Dessert, Forchetta Frutta, Dessertgabel	1,43 €	12-120 / 12	180	
H	10645 Tenedor Lunch Cake Fork, Fourchette Gâteau, Forchetta Dolce, Kuchengabel	1,15 €	12-120 / 12	148	2
I	10646 Cuchara Café Tea Spoon, Cuillère Café, Cucchiaio Caffé, Kaffeelöffel	1,15 €	12-120 / 12	140	2
J	10647 Cuchara Moka Coffee/Moka Spoon, Cuillère Moka, Cucchiaio Moka, Mokkalöffe	1,08 €	12-120 / 12	116	2
B	10928 Mazo 2 Cuchillo Mesa Film 2 Table Knife, Film 2 Couteau Table, Film 2 Coltello Tavola, Film 2 Tafelmesser	6,89 €	0-48 / 48	235	
C	10929 Mazo 3 Cuchara Mesa Film 3 Table Spoon, Film 3 Cuillère Table, Film 3 Cucchiaio Tavola, Film 3 Löffel	6,89 €	0-48 / 48	200	
G	10930 Mazo 3 Tenedor Mesa Film 3 Table Fork, Film 3 Fourchette Table, Film 3 Forchetta Tavola, Film 3 Tafelgabel	6,89 €	0-48 / 48	200	
H	10931 Mazo 6 Tenedor Lunch Film 6 Cake Fork, Film 6 Fourchette Gâteau, Film 6 Forchetta Dolce, Film 6 Kuchengabel	6,89 €	0-48 / 48	148	
I	10932 Mazo 6 Cuchara Café Film 6 Tea Spoon, Film 6 Cuillère Café, Film 6 Cucchiaio Caffé, Film 6 Kaffeelöffel	6,89 €	0-48 / 48	148	
J	10933 Mazo 6 Cuchara Moka Film 6 Coffee/Moka Spoon, Film 6 Cuillère Moka, Film 6 Cucchiaio Moka, Film 6 Mokkalöffel	6,89 €	0-48 / 48	116	

5187	24 Piezas 24 Pieces, Écrin 24 Pièces, Bauletto 24 Pz., 24 Stück	54,35 €	1-4 / 1		
-------------	---	---------	---------	--	--



SANTORINI



B C D E F G H I J

CHEF FREE

INOX Nickel Free 18% / 3,5mm / Mirror

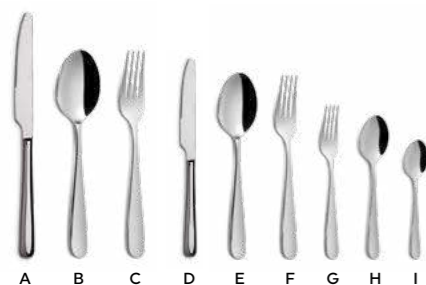

LOTUS FREE

INOX Nickel Free 18% / 3,5mm / Mirror

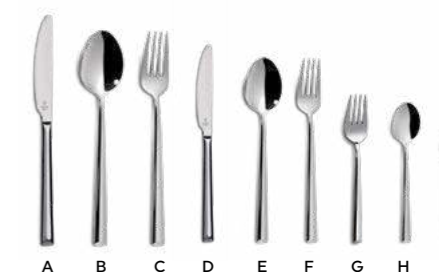

REF.	Descripción	€	UE/MOQ	▶ mm	✂ mm
A 5033	Cuchillo Mesa Table Knife, Couteau Table, Coltello Tavola, Tafelmesser	3,20 €	6-60 / 6	235	
B 9626	Cuchara Mesa Table Spoon, Cuillère Table, Cucchiaino Tavola, Tafellöffel	1,82 €	12-120 / 12	200	3,5
C 9627	Tenedor Mesa Table Fork, Fourchette Table, Forchetta Tavola, Tafelgabel	1,82 €	12-120 / 12	200	3,5
D 5034	Cuchillo Postre Dessert Knife, Couteau Dessert, Coltello Frutta, Dessertmesser	2,89 €	6-60 / 6	210	
E 10835	Cuchara Postre Dessert Spoon, Cuillère Dessert, Cucchiaino Frutta, Dessertlöffel	1,43 €	12-120 / 12	180	2,5
F 10836	Tenedor Postre Dessert Fork, Fourchette Dessert, Forchetta Frutta, Dessertgabel	1,43 €	12-120 / 12	180	2,5
G 10837	Tenedor Lunch Cake Fork, Fourchette Gâteau, Forchetta Dolce, Kuchengabel	1,12 €	12-120 / 12	148	2
H 9628	Cuchara Café Tea Spoon, Cuillère Café, Cucchiaino Caffé, Kaffeelöffel	1,10 €	12-120 / 12	140	2
I 10838	Cuchara Moka Coffee/Moka Spoon, Cuillère Moka, Cucchiaino Moka, Mokkalöffel	1,05 €	12-120 / 12	116	2

REF.	Descripción	€	UE/MOQ	▶ mm	✂ mm
A 3139	Cuchillo Mesa Table Knife, Couteau Table, Coltello Tavola, Tafelmesser	3,16 €	6-60 / 6	225	
B 9629	Cuchara Mesa Table Spoon, Cuillère Table, Cucchiaino Tavola, Tafellöffel	1,79 €	12-120 / 12	211	3,5
C 9630	Tenedor Mesa Table Fork, Fourchette Table, Forchetta Tavola, Tafelgabel	1,79 €	12-120 / 12	211	3,5
D 3145	Cuchillo Postre Dessert Knife, Couteau Dessert, Coltello Frutta, Dessertmesser	2,74 €	6-60 / 6	195	
E 5255	Cuchara Postre Dessert Spoon, Cuillère Dessert, Cucchiaino Frutta, Dessertlöffel	1,54 €	12-120 / 12	188	3
F 5256	Tenedor Postre Dessert Fork, Fourchette Dessert, Forchetta Frutta, Dessertgabel	1,54 €	12-120 / 12	186	3
G 5257	Tenedor Lunch Cake Fork, Fourchette Gâteau, Forchetta Dolce, Kuchengabel	1,26 €	12-120 / 12	147	3
H 9631	Cuchara Café Tea Spoon, Cuillère Café, Cucchiaino Caffé, Kaffeelöffel	1,26 €	12-120 / 12	139	3
I 5258	Cuchara Moka Coffee/Moka Spoon, Cuillère Moka, Cucchiaino Moka, Mokkalöffel	1,16 €	12-120 / 12	114	2,5

KYOTO

INOX Nickel Free 18% / 5,5mm / Mirror / Satin

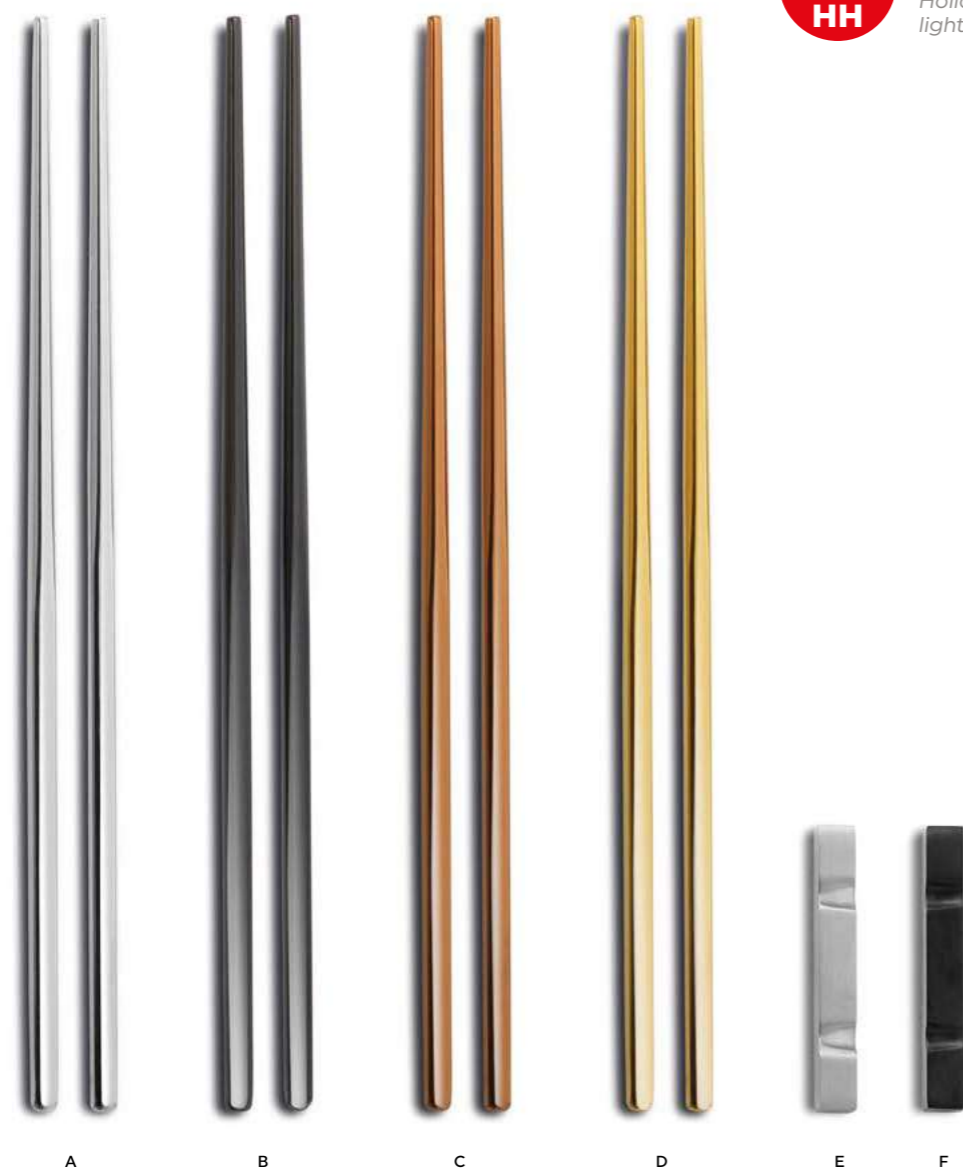

Mango hueco para una manipulación más ligera.
Hollow handle for lighter handling.

NEW

LINO

INOX Nickel Free 18% / 2,5mm / Satin



REF.	Descripción	€	UE/MOQ	▶ mm	✂ mm
A 7421	Set Palillos Inox Chopsticks Set 18/10, Set Baguettes 18/10, Set Baguettes 18/10, Esstübchen Set 18/10	3,11 €	12-120 / 12	230	5,5
B 7422	Set Palillos Black Chopsticks Set Black 18/10, Set Baguettes Black 18/10, Set Baguettes Black 18/10, Esstübchen Set 18/10 Black	3,58 €	12-120 / 12	230	5,5
C 7423	Set Palillos Copper Chopsticks Set Copper 18/10, Set Baguettes Copper 18/10, Set Baguettes Copper 18/10, Esstübchen Set 18/10 Copper	3,58 €	12-120 / 12	230	5,5
D 7424	Set Palillos Gold Chopsticks Set Gold 18/10, Set Baguettes Gold 18/10, Set Baguettes Gold 18/10, Esstübchen Set 18/10 Gold	3,58 €	12-120 / 12	230	5,5
E 7554	Reposa Palillos Bloque Satin Chopsticks Rest Satin 18/10, Porte Baguette Satin 18/10, Supporto Posate Satin 18/10, Besteckhalter Satin 18/10	3,89 €	12-120 / 12	60	
F 7555	Reposa Palillos Bloque Negro Chopsticks Rest Black 18/10, Porte Baguette Black 18/10, Supporto Posate Black 18/10, Besteckhalter Black 18/10	4,67 €	12-120 / 12	60	

REF.	Descripción	€	UE/MOQ	▶ mm	✂ mm
10863	24 Piezas 24 Pieces, Écrin 24 Pièces, Bauletto 24 Pz., 24 Stück	62,50 €	1-4 / 1	225	2,5



CHEESE

INOX Nickel Free 18% / 3mm / Mirror

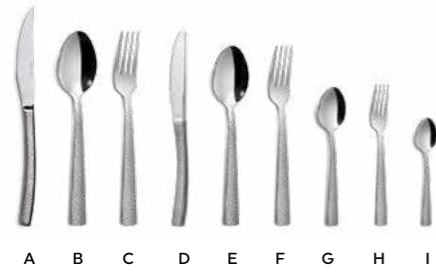

NEW

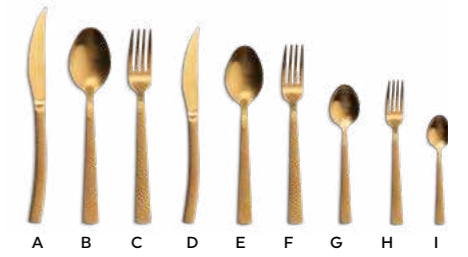

CHEESE SATIN GOLD

INOX Nickel Free 18% / 3mm / Satin

REF.	Descripción	€	UE/MOQ	▶ mm	✂ mm
A 5610	Cuchillo Chuletero Steak Knife, Couteau Steak, Coltello Bistecca, Steakmesser	2,69 €	12-120 / 12	225	7
B 5611	Cuchara Mesa Table Spoon, Cuillère Table, Cucchiaio Tavola, Tafellöffel	1,68 €	12-120 / 12	200	3
C 5612	Tenedor Mesa Table Fork, Fourchette Table, Forchetta Tavola, Tafelgabel	1,68 €	12-120 / 12	200	3
D 5615	Cuchillo Postre Dessert Knife, Couteau Dessert, Coltello Frutta, Dessertmesser	2,56 €	12-120 / 12	200	
E 5613	Cuchara Postre Dessert Spoon, Cuillère Dessert, Cucchiaio Frutta, Dessertlöffel	1,59 €	12-120 / 12	184	2
F 5614	Tenedor Postre Dessert Fork, Fourchette Dessert, Forchetta Frutta, Dessertgabel	1,59 €	12-120 / 12	184	2
G 5593	Cuchara Café Tea Spoon, Cuillère Café, Cucchiaio Caffé, Kaffeelöffel	0,98 €	12-120 / 12	142	2
H 5595	Tenedor Lunch Cake Fork, Fourchette Gâteau, Forchetta Dolce, Kuchengabel	0,98 €	12-120 / 12	145	2
I 5594	Cuchara Moka Coffee/Moka Spoon, Cuillère Moka, Cucchiaio Moka, Mokkalöffel	0,92 €	12-120 / 12	110	1,8
5616	Mazo 2 Cuchillo Chuletero Film 2 Steak Knife, Film 2 Couteau Steak, Film 2 Coltello Bistecca, Film 2 Steakmesser	5,51 €	0-48 / 48	225	
5617	Mazo 3 Cuchara Mesa Film 3 Table Spoon, Film 3 Cuillère Table, Film 3 Cucchiaio Tavola, Film 3 Löffel	5,51 €	0-48 / 48	200	3
5618	Mazo 3 Tenedor Mesa Film 3 Table Fork, Film 3 Fourchette Table, Film 3 Forchetta Tavola, Film 3 Tafelgabel	5,51 €	0-48 / 48	200	3
5619	Mazo 6 Tenedor Lunch Film 6 Cake Fork, Film 6 Fourchette Gâteau, Film 6 Forchetta Dolce, Film 6 Kuchengabel	5,51 €	0-48 / 48	145	2
5620	Mazo 6 Cuchara Café Film 6 Tea Spoon, Film 6 Cuillère Café, Film 6 Cucchiaio Caffé, Film 6 Kaffeelöffel	5,51 €	0-48 / 48	142	2
5621	Mazo 6 Cuchara Moka Film 6 Coffee/Moka Spoon, Film 6 Cuillère Moka, Film 6 Cucchiaio Moka, Film 6 Mokkalöffel	5,51 €	0-48 / 48	110	1,8
2894	24 Piezas 24 Pieces, Écrin 24 Pièces, Bauletto 24 Pz., 24 Stück	37,32 €	1-4 / 1		2,5



REF.	Descripción	€	UE/MOQ	▶ mm	✂ mm
A 12069	Cuchillo Chuletero Steak Knife, Couteau Steak, Coltello Bistecca, Steakmesser	4,00 €	12-120 / 12	225	
B 12070	Cuchara Mesa Table Spoon, Cuillère Table, Cucchiaio Tavola, Tafellöffel	3,38 €	12-120 / 12	200	3
C 12071	Tenedor Mesa Table Fork, Fourchette Table, Forchetta Tavola, Tafelgabel	3,38 €	12-120 / 12	200	3
D 12072	Cuchillo Postre Dessert Knife, Couteau Dessert, Coltello Frutta, Dessertmesser	3,75 €	12-120 / 12	200	
E 12073	Cuchara Postre Dessert Spoon, Cuillère Dessert, Cucchiaio Frutta, Dessertlöffel	2,88 €	12-120 / 12	184	2
F 12074	Tenedor Postre Dessert Fork, Fourchette Dessert, Forchetta Frutta, Dessertgabel	2,88 €	12-120 / 12	184	2
G 12075	Tenedor Lunch Cake Fork, Fourchette Gâteau, Forchetta Dolce, Kuchengabel	2,50 €	12-120 / 12	145	2
H 12076	Cuchara Café Tea Spoon, Cuillère Café, Cucchiaio Caffé, Kaffeelöffel	2,50 €	12-120 / 12	142	2
I 12077	Cuchara Moka Coffee/Moka Spoon, Cuillère Moka, Cucchiaio Moka, Mokkalöffel	2,38 €	12-120 / 12	110	1,8
12169	16 Piezas 16 Pieces, Écrin 16 Pièces, Bauletto 16 Pz., 16 Stück	50,00 €	1-4 / 1		
12078	24 Piezas 24 Pieces, Écrin 24 Pièces, Bauletto 24 Pz., 24 Stück	75,00 €	1-4 / 1		2,5



CHEESE SATIN COPPER

INOX Nickel Free 18% / 3mm / Satin

NEW

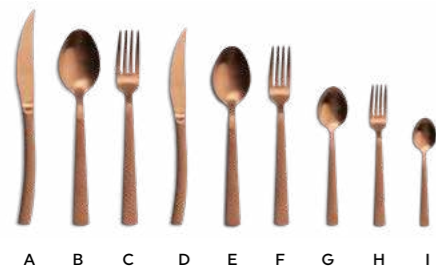

REF.	Descripción	€	UE/MOQ	▶ mm	✂ mm
A 12079	Cuchillo Chuletero Steak Knife, Couteau Steak, Coltello Bistecca, Steakmesser	4,00 €	12-120 / 12	225	7
B 12080	Cuchara Mesa Table Spoon, Cuillère Table, Cucchiaino Tavola, Tafellöffel	3,38 €	12-120 / 12	200	3
C 12081	Tenedor Mesa Table Fork, Fourchette Table, Forchetta Tavola, Tafelgabel	3,38 €	12-120 / 12	200	3
D 12082	Cuchillo Postre Dessert Knife, Couteau Dessert, Coltello Frutta, Dessertmesser	3,75 €	12-120 / 12	200	
E 12083	Cuchara Postre Dessert Spoon, Cuillère Dessert, Cucchiaino Frutta, Dessertlöffel	2,88 €	12-120 / 12	184	2
F 12084	Tenedor Postre Dessert Fork, Fourchette Dessert, Forchetta Frutta, Dessertgabel	2,88 €	12-120 / 12	184	2
G 12085	Tenedor Lunch Cake Fork, Fourchette Gâteau, Forchetta Dolce, Kuchengabel	2,50 €	12-120 / 12	142	2
H 12086	Cuchara Café Tea Spoon, Cuillère Café, Cucchiaino Caffé, Kaffeelöffel	2,50 €	12-120 / 12	145	2
I 12087	Cuchara Moka Coffee/Moka Spoon, Cuillère Moka, Cucchiaino Moka, Mokkalöffel	2,38 €	12-120 / 12	110	1,8
12170	16 Piezas 16 Pieces, Écrin 16 Pièces, Bauletto 16 Pz., 16 Stück	50,00 €	1-4 / 1		
12088	24 Piezas 24 Pieces, Écrin 24 Pièces, Bauletto 24 Pz., 24 Stück	75,00 €	1-4 / 1		2,5



NEW

CHEESE SATIN BLACK

INOX Nickel Free 18% / 3mm / Satin

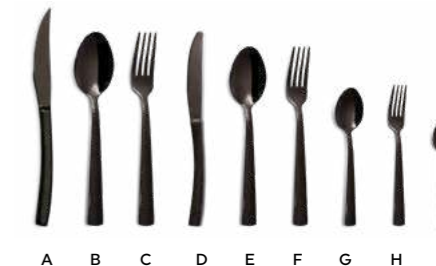

REF.	Descripción	€	UE/MOQ	▶ mm	✂ mm
A 12089	Cuchillo Chuletero Steak Knife, Couteau Steak, Coltello Bistecca, Steakmesser	4,00 €	12-120 / 12	225	7
B 12090	Cuchara Mesa Table Spoon, Cuillère Table, Cucchiaino Tavola, Tafellöffel	3,38 €	12-120 / 12	200	3
C 12091	Tenedor Mesa Table Fork, Fourchette Table, Forchetta Tavola, Tafelgabel	3,38 €	12-120 / 12	200	3
D 12092	Cuchillo Postre Dessert Knife, Couteau Dessert, Coltello Frutta, Dessertmesser	3,75 €	12-120 / 12	200	
E 12093	Cuchara Postre Dessert Spoon, Cuillère Dessert, Cucchiaino Frutta, Dessertlöffel	2,88 €	12-120 / 12	184	2
F 12094	Tenedor Postre Dessert Fork, Fourchette Dessert, Forchetta Frutta, Dessertgabel	2,88 €	12-120 / 12	184	2
G 12095	Tenedor Lunch Cake Fork, Fourchette Gâteau, Forchetta Dolce, Kuchengabel	2,50 €	12-120 / 12	142	2
H 12096	Cuchara Café Tea Spoon, Cuillère Café, Cucchiaino Caffé, Kaffeelöffel	2,50 €	12-120 / 12	145	2
I 12097	Cuchara Moka Coffee/Moka Spoon, Cuillère Moka, Cucchiaino Moka, Mokkalöffel	2,38 €	12-120 / 12	110	1,8
12171	16 Piezas 16 Pieces, Écrin 16 Pièces, Bauletto 16 Pz., 16 Stück	50,00 €	1-4 / 1		
12098	24 Piezas 24 Pieces, Écrin 24 Pièces, Bauletto 24 Pz., 24 Stück	75,00 €	1-4 / 1		2,5



HIDRAULIC

INOX Nickel Free 18% / 3mm / Mirror



REF.	Descripción	€	UE/MOQ	▶ mm	✂ mm
A 6464	Cuchillo Chuletero Steak Knife, Couteau Steak, Coltello Bistecca, Steakmesser	2,83 €	12-120 / 12	220	
B 6326	Cuchillo Mesa Table Knife, Couteau Table, Coltello Tavola, Tafelmesser	2,83 €	12-120 / 12	220	
C 6327	Cuchara Mesa Table Spoon, Cuillère Table, Cucchiaio Tavola, Tafellöffel	1,82 €	12-120 / 12	200	3
D 6328	Tenedor Mesa Table Fork, Fourchette Table, Forchetta Tavola, Tafelgabel	1,82 €	12-120 / 12	200	3
E 6329	Tenedor Lunch Cake Fork, Fourchette Gâteau, Forchetta Dolce, Kuchengabel	1,04 €	12-120 / 12	140	2
F 6331	Cuchara Café Tea Spoon, Cuillère Café, Cucchiaio Caffé, Kaffeelöffel	1,04 €	12-120 / 12	140	2
G 6330	Cuchara Moka Coffee/Moka Spoon, Cuillère Moka, Cucchiaio Moka, Mokkalöffel	1,00 €	12-120 / 12	110	2
6499	Mazo 2 Cuchillo Chuletero Film 2 Steak Knife, Film 2 Couteau Steak, Film 2 Coltello Bistecca, Film 2 Steakmesser	5,65 €	0-48 / 48	220	
6344	Mazo 2 Cuchillo Mesa Film 2 Table Knife, Film 2 Couteau Table, Film 2 Coltello Tavola, Film 2 Tafelmesser	5,65 €	0-48 / 48	220	
6345	Mazo 3 Cuchara Mesa Film 3 Table Spoon, Film 3 Cuillère Table, Film 3 Cucchiaio Tavola, Film 3 Tafellöffel	5,65 €	0-48 / 48	200	3
6346	Mazo 3 Tenedor Mesa Film 3 Table Fork, Film 3 Fourchette Table, Film 3 Forchetta Tavola, Film 3 Tafelgabel	5,65 €	0-48 / 48	200	3
6347	Mazo 6 Tenedor Lunch Film 6 Cake Fork, Film 6 Fourchette Gâteau, Film 6 Forchetta Dolce, Film 6 Kuchengabel	5,65 €	0-48 / 48	140	2
6348	Mazo 6 Cuchara Café Film 6 Tea Spoon, Film 6 Cuillère Café, Film 6 Cucchiaio Caffé, Film 6 Kaffeelöffel	5,65 €	0-48 / 48	140	2
6349	Mazo 6 Cuchara Moka Film 6 Coffee/Moka Spoon, Film 6 Cuillère Moka, Film 6 Cucchiaio Moka, Film 6 Mokkalöffel	5,65 €	0-48 / 48	110	2
6332	24 Piezas 24 Pieces, Écrin 24 Pièces, Bauletto 24 Pz, 24 Stück	46,24 €	1-4 / 1		3

HIDRAULIC

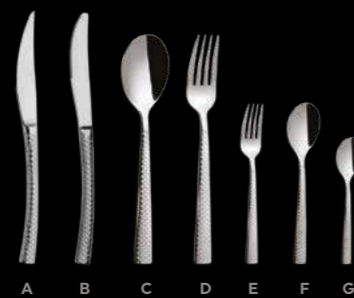

MADRID

INOX Nickel Free 18% / 3mm / Mirror



REF.	Descripción	€	UE/MOQ	▶ mm	✂ mm
A 1339	Cuchillo Chuletero Steak Knife, Couteau Steak, Coltello Bistecca, Steakmesser	2,50 €	12-120 / 12	224	
B 2775	Cuchillo Mesa Table Knife, Couteau Table, Coltello Tavola, Tafelmesser	2,43 €	12-120 / 12	221	
C 1340	Cuchara Mesa Table Spoon, Cuillère Table, Cucchiao Tavola, Tafellöffel	1,50 €	12-120 / 12	200	3
D 1341	Tenedor Mesa Table Fork, Fourchette Table, Forchetta Tavola, Tafelgabel	1,50 €	12-120 / 12	200	3
E 6114	Pala Pescado Fish Knife, Couteau Poisson, Coltello Pesce, Fischmesser	1,50 €	12-120 / 12	200	3
F 9653	Tenedor Pescado Fish Fork, Fourchette Poisson, Forchetta Pesce, Fischgabel	1,50 €	12-120 / 12	200	3
G 6115	Cuchillo Postre Dessert Knife, Couteau Dessert, Coltello Frutta, Dessertmesser	2,30 €	12-120 / 12	204	
H 1595	Cuchara Postre Dessert Spoon, Cuillère Dessert, Cucchiao Frutta, Dessertlöffel	1,38 €	12-120 / 12	183	3
I 6117	Tenedor Postre Dessert Fork, Fourchette Dessert, Forchetta Frutta, Dessertgabel	1,38 €	12-120 / 12	185	3
J 9655	Tenedor Lunch Cake Fork, Fourchette Gâteau, Forchetta Dolce, Kuchengabel	0,89 €	12-120 / 12	140	2
K 1342	Cuchara Café Tea Spoon, Cuillère Café, Cucchiao Caffé, Kaffeelöffel	0,89 €	12-120 / 12	135	2
L 9654	Cuchara Moka Coffee/Moka Spoon, Cuillère Moka, Cucchiao Moka, Mokkalöffel	0,84 €	12-120 / 12	110	2
M 1619	Cazo Sopa Soup Ladle, Louche À Potage, Mestolo, Suppenkelle	8,45 €	10-50 / 10	268	3
N 1620	Cuchara Ensalada Salad Spoon, Cuillère À Servir Salade, Cucchiao Servire, Salatlöffel	4,24 €	10-50 / 10	270	3
O 1622	Tenedor Ensalada Salad Fork, Fourchette À Servir Salade, Forchetta Servire, Salatgabel	4,24 €	10-50 / 10	265	3
P 1621	Pala Lasaña Lasagna Server, Pelle À Lasagne, Pala Lasagna, Lasagneheber	4,70 €	10-50 / 10	235	3
Q 1625	Cazo Salsa Sauce Ladle, Cuillère À Sauce, Mestolino Salsa, Soßenkelle	4,70 €	10-50 / 10	180	3
1193	Mazo 2 Cuchillo Chuletero Film 2 Steak Knife, Film 2 Couteau Steak, Film 2 Coltello Bistecca, Film 2 Steakmesser	5,28 €	0-48 / 48	224	
1194	Mazo 3 Cuchara Mesa Film 3 Table Spoon, Film 3 Cuillère Table, Film 3 Cucchiao Tavola, Film 3 Tafellöffel	5,28 €	0-48 / 48	200	3
1195	Mazo 3 Tenedor Mesa Film 3 Table Fork, Film 3 Fourchette Table, Film 3 Forchetta Tavola, Film 3 Tafelgabel	5,28 €	0-48 / 48	200	3
1078	Mazo 2 Cuchillo Postre Film 2 Dessert Knife, Film 2 Couteau Dessert, Film 2 Coltello Frutta, Film 2 Dessertmesser	5,28 €	0-48 / 48	204	
1079	Mazo 3 Cuchara Postre Film 3 Dessert Spoon, Film 3 Cuillère Dessert, Film 3 Cucchiao Frutta, Film 3 Dessertlöffel	5,28 €	0-48 / 48	183	3
1080	Mazo 3 Tenedor Postre Film 3 Dessert Fork, Film 3 Fourchette Dessert, Film 3 Forchetta Frutta, Film 3 Dessertgabel	5,28 €	0-48 / 48	185	3
1196	Mazo 6 Tenedor Lunch Film 6 Cake Fork, Film 6 Fourchette Gâteau, Film 6 Forchetta Dolce, Film 6 Kuchengabel	5,28 €	0-48 / 48	140	2
1197	Mazo 6 Cuchara Café Film 6 Tea Spoon, Film 6 Cuillère Café, Film 6 Cucchiao Caffé, Film 6 Kaffeelöffel	5,28 €	0-48 / 48	135	2
1198	Mazo 6 Cuchara Moka Film 6 Coffee/Moka Spoon, Film 6 Cuillère Moka, Film 6 Cucchiao Moka, Film 6 Mokkalöffel	5,28 €	0-48 / 48	110	2

MADRID

INOX Nickel Free 18% / 3mm / Mirror



REF.	Descripción	€	UE/MOQ	▶ mm	✂ mm
2895	24 Piezas 24 Pieces, Écrin 24 Pièces, Bauletto 24 Pz., 24 Stück	41,56 €	1-4 / 1		2,5

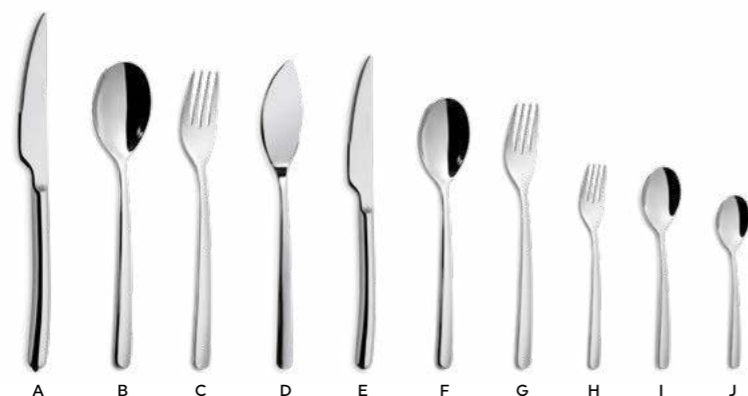

REF.	Descripción	€	UE/MOQ	▶ mm	✂ mm
A 2283	Cuchillo Mesa Table Knife, Couteau Table, Coltello Tavola, Tafelmesser	2,69 €	12-120 / 12	240	
B 2274	Cuchara Mesa Table Spoon, Cuillère Table, Cucchiaio Tavola, Tafellöffel	1,65 €	12-120 / 12	200	3
C 2275	Tenedor Mesa Table Fork, Fourchette Table, Forchetta Tavola, Tafelgabel	1,65 €	12-120 / 12	200	3
D 2758	Pala Pescado Fish Knife, Couteau Poisson, Coltello Pesce, Fischmesser	1,56 €	12-120 / 12	206	3
E 2284	Cuchillo Postre Dessert Knife, Couteau Dessert, Coltello Frutta, Dessertmesser	2,57 €	12-120 / 12	210	
F 2759	Cuchara Postre Dessert Spoon, Cuillère Dessert, Cucchiaio Frutta, Dessertlöffel	1,56 €	12-120 / 12	180	3
G 2760	Tenedor Postre Dessert Fork, Fourchette Dessert, Forchetta Frutta, Dessertgabel	1,56 €	12-120 / 12	178	3
H 2761	Tenedor Lunch Cake Fork, Fourchette Gâteau, Forchetta Dolce, Kuchengabel	0,95 €	12-120 / 12	137	2
I 2762	Cuchara Café Tea Spoon, Cuillère Café, Cucchiaio Caffé, Kaffeelöffel	0,95 €	12-120 / 12	134	2
J 2763	Cuchara Moka Coffee/Moka Spoon, Cuillère Moka, Cucchiaio Moka, Mokkalöffel	0,92 €	12-120 / 12	115	2
M2283	Mazo 2 Cuchillo Mesa Film 2 Table Knife, Film 2 Couteau Table, Film 2 Coltello Tavola, Film 2 Tafelmesser	5,28 €	0-48 / 48	240	
M2274	Mazo 3 Cuchara Mesa Film 3 Table Spoon, Film 3 Cuillère Table, Film 3 Cucchiaio Tavola, Film 3 Tafellöffel	5,28 €	0-48 / 48	200	3
M2275	Mazo 3 Tenedor Mesa Film 3 Table Fork, Film 3 Fourchette Table, Film 3 Forchetta Tavola, Film 3 Tafelgabel	5,28 €	0-48 / 48	200	3
M5084	Mazo 2 Cuchillo Postre Film 2 Dessert Knife, Film 2 Couteau Dessert, Film 2 Coltello Frutta, Film 2 Dessertmesser	5,28 €	0-48 / 48	210	
M2759	Mazo 3 Cuchara Postre Film 3 Dessert Spoon, Film 3 Cuillère Dessert, Film 3 Cucchiaio Frutta, Film 3 Dessertlöffel	5,28 €	0-48 / 48	180	3
M2760	Mazo 3 Tenedor Postre Film 3 Dessert Fork, Film 3 Fourchette Dessert, Film 3 Forchetta Frutta, Film 3 Dessertgabel	5,28 €	0-48 / 48	178	3
M2761	Mazo 6 Tenedor Lunch Film 6 Cake Fork, Film 6 Fourchette Gâteau, Film 6 Forchetta Dolce, Film 6 Kuchengabel	5,28 €	0-48 / 48	137	2
M2762	Mazo 6 Cuchara Café Film 6 Tea Spoon, Film 6 Cuillère Café, Film 6 Cucchiaio Caffé, Film 6 Kaffeelöffel	5,28 €	0-48 / 48	134	2
M2763	Mazo 6 Cuchara Moka Film 6 Coffee/Moka Spoon, Film 6 Cuillère Moka, Film 6 Cucchiaio Moka, Film 6 Mokkalöffel	5,28 €	0-48 / 48	115	2



REF.	Descripción	€	UE/MOQ	▶ mm	✂ mm
2764	24 Piezas 24 Pieces, Écrin 24 Pièces, Bauletto 24 Pz., 24 Stück	41,56 €	1-4 / 1		2,5



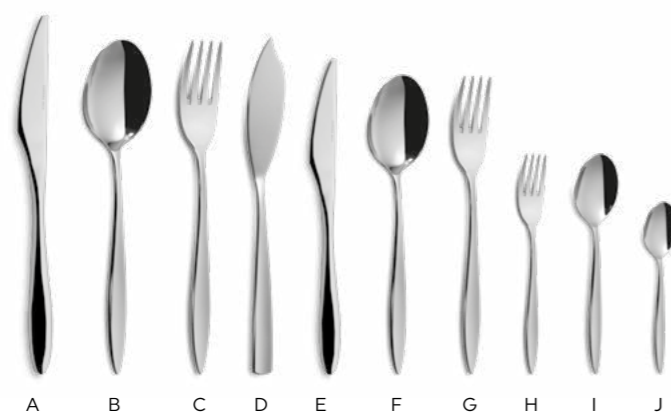

REF.	Descripción	€	UE/MOQ	▶ mm	✂ mm
A 2774	Cuchillo Mesa Table Knife, Couteau Table, Coltello Tavola, Tafelmesser	2,79 €	12-120 / 12	229	
B 2710	Cuchara Mesa Table Spoon, Cuillère Table, Cucchiaio Tavola, Tafellöffel	1,65 €	12-120 / 12	213	3
C 2711	Tenedor Mesa Table Fork, Fourchette Table, Forchetta Tavola, Tafelgabel	1,65 €	12-120 / 12	213	3
D 2734	Pala Pescado Fish Knife, Couteau Poisson, Coltello Pesce, Fischmesser	1,56 €	12-120 / 12	215	2,5
E 5826	Cuchillo Postre Dessert Knife, Couteau Dessert, Coltello Frutta, Dessertmesser	2,72 €	12-120 / 12	200	
F 2712	Cuchara Postre Dessert Spoon, Cuillère Dessert, Cucchiaio Frutta, Dessertlöffel	1,56 €	12-120 / 12	190	2,5
G 2713	Tenedor Postre Dessert Fork, Fourchette Dessert, Forchetta Frutta, Dessertgabel	1,56 €	12-120 / 12	190	2,5
H 2714	Tenedor Lunch Cake Fork, Fourchette Gâteau, Forchetta Dolce, Kuchengabel	0,95 €	12-120 / 12	140	2
I 2715	Cuchara Café Tea Spoon, Cuillère Café, Cucchiaio Caffé, Kaffeelöffel	0,95 €	12-120 / 12	140	2
J 2716	Cuchara Moka Coffee/Moka Spoon, Cuillère Moka, Cucchiaio Moka, Mokkalöffel	0,92 €	12-120 / 12	109	1,5
M2297	Mazo 2 Cuchillo Mesa Film 2 Table Knife, Film 2 Couteau Table, Film 2 Coltello Tavola, Film 2 Tafelmesser	5,28 €	0-48 / 48	229	
M2710	Mazo 3 Cuchara Mesa Film 3 Table Spoon, Film 3 Cuillère Table, Film 3 Cucchiaio Tavola, Film 3 Tafellöffel	5,28 €	0-48 / 48	213	3
M2711	Mazo 3 Tenedor Mesa Film 3 Table Fork, Film 3 Fourchette Table, Film 3 Forchetta Tavola, Film 3 Tafelgabel	5,28 €	0-48 / 48	213	3
M2161	Mazo 2 Cuchillo Postre Film 2 Dessert Knife, Film 2 Couteau Dessert, Film 2 Coltello Frutta, Film 2 Dessertmesser	5,28 €	0-48 / 48	200	
M2712	Mazo 3 Cuchara Postre Film 3 Dessert Spoon, Film 3 Cuillère Dessert, Film 3 Cucchiaio Frutta, Film 3 Dessertlöffel	5,28 €	0-48 / 48	190	2,5
M2713	Mazo 3 Tenedor Postre Film 3 Dessert Fork, Film 3 Fourchette Dessert, Film 3 Forchetta Frutta, Film 3 Dessertgabel	5,28 €	0-48 / 48	190	2,5
M2714	Mazo 6 Tenedor Lunch Film 6 Cake Fork, Film 6 Fourchette Gâteau, Film 6 Forchetta Dolce, Film 6 Kuchengabel	5,28 €	0-48 / 48	140	2
M2715	Mazo 6 Cuchara Café Film 6 Tea Spoon, Film 6 Cuillère Café, Film 6 Cucchiaio Caffé, Film 6 Kaffeelöffel	5,28 €	0-48 / 48	140	2
M2716	Mazo 6 Cuchara Moka Film 6 Coffee/Moka Spoon, Film 6 Cuillère Moka, Film 6 Cucchiaio Moka, Film 6 Mokkalöffel	5,28 €	0-48 / 48	109	1,5



REF.	Descripción	€	UE/MOQ	▶ mm	✂ mm
2757	24 Piezas 24 Pieces, Écrin 24 Pièces, Bauletto 24 Pz, 24 Stück	41,56 €	4		3



VIEUX PARIS

INOX Nickel Free 18% / 3mm / Mirror + Satin



Acabado mirror
Mirror finish

Acabado satinado
Satin finish

Siempre presentes. Siempre Comas.

Nuestra extensa gama de colecciones de cubiertos tiene una razón fundamental. En nuestro ADN está la vocación de poder ofrecer siempre la calidad y el diseño que nuestros clientes necesitan. La restauración profesional es enormemente diversa y en constante evolución. Nuestra oferta también.

Always present. Always Comas.

There is a key rationale behind our extensive range of cutlery collections. It is in our DNA to always offer the quality and design that our customers need. Professional foodservice is hugely diverse and ever-evolving. So is our offer.



REF.	Descripción	€	UE/MOQ	▶ mm	✂ mm
A 5795	Cuchillo Mesa Table Knife, Couteau Table, Coltello Tavola, Tafelmesser	2,84 €	12-120 / 12	238	
B 5796	Cuchara Mesa Table Spoon, Cuillère Table, Cucchiaio Tavola, Tafellöffel	1,85 €	12-120 / 12	210	3
C 5797	Tenedor Mesa Table Fork, Fourchette Table, Forchetta Tavola, Tafelgabel	1,85 €	12-120 / 12	208	3
D 5798	Cuchillo Postre Dessert Knife, Couteau Dessert, Coltello Frutta, Dessertmesser	2,59 €	12-120 / 12	215	
E 5799	Cuchara Postre Dessert Spoon, Cuillère Dessert, Cucchiaio Frutta, Dessertlöffel	1,41 €	12-120 / 12	178	2,5
F 5800	Tenedor Postre Dessert Fork, Fourchette Dessert, Forchetta Frutta, Dessertgabel	1,41 €	12-120 / 12	178	2,5
G 5801	Cuchara Café Tea Spoon, Cuillère Café, Cucchiaio Caffé, Kaffeelöffel	1,03 €	12-120 / 12	143	2
H 5802	Cuchara Moka Coffee/Moka Spoon, Cuillère Moka, Cucchiaio Moka, Mokkalöffel	0,91 €	12-120 / 12	112	2





REF.	Descripción	€	UE/MOQ	▶ mm	✂ mm
A 0094	CUCHILLO MESA table knife, couteau table, coltello tavola, tafelmesser	2,28 €	12-120 / 12	225	
B 5631	CUCHILLO CHULETERO steak knife, couteau steak, coltello bistecca, steakmesser	2,48 €	12-120 / 12	230	
C 9657	CUCHARA MESA table spoon, cuillère table, cucchiaio tavola, tafellöffel	1,55 €	12-120 / 12	209	3
D 9658	TENEDOR MESA table fork, fourchette table, forchetta tavola, tafelgabel	1,55 €	12-120 / 12	210	3
E 9659	PALA PESCADO fish knife, couteau poisson, coltello pesce, fischmesser	1,30 €	12-120 / 12	200	2,5
F 9660	TENEDOR PESCADO fish fork, fourchette poisson, forchetta pesce, fischgabel	1,30 €	12-120 / 12	197	2,5
G 0099	CUCHILLO POSTRE dessert knife, couteau dessert, coltello frutta, dessertmesser	1,80 €	12-120 / 12	195	
H 9662	CUCHARA POSTRE dessert spoon, cuillère à dessert, cucchiaio frutta, dessertlöffel	1,13 €	12-120 / 12	178	2,5
I 9663	TENEDOR POSTRE dessert fork, fourchette à dessert, forchetta frutta, dessertgabel	1,13 €	12-120 / 12	183	2,5
J 11930	TENEDOR LUNCH cake fork, fourchette gâteau, forchetta dolce, kuchengabel	0,85 €	12-120 / 12	148	2
K 9665	CUCHARA CAFÉ tea spoon, cuillère café, cucchiaio caffè, kaffeelöffel	0,85 €	12-120 / 12	138	2
L 9666	CUCHARA MOKA coffee/moka spoon, cuillère moka, cucchiaio moka, mokkalöffel	0,83 €	12-120 / 12	117	2
M 1626	CAZO SOPA soup ladle, louche à potage, mestolo, suppenkelle	7,12 €	10-50 / 10	260	2,5
N 1627	CUCHARA SERVIR serving spoon, cuillère à servir, cucchiaio servir, servierlöffel	4,42 €	10-50 / 10	235	2,5
O 1628	TENEDOR SERVIR serving fork, fourchette à servir, forchetta servire, serviergabel	4,28 €	10-50 / 10	235	2,5
P 1629	PALA REPOSTERÍA cake server, pelle à tarte, pala torta, tortenheber	4,28 €	10-50 / 10	240	2,7
Q 1632	CAZO SALSAS sauce ladle, cuillère à sauce, mestolino salsa, soßenkelle	6,91 €	10-50 / 10	170	2,7

REF.	Descripción	€	UE/MOQ	▶ mm	✂ mm
1297	MAZO 2 CUCHILLO CHULETERO film 2 steak knife, film 2 couteau steak, film 2 coltello bistecca, film 2 steakmesser	5,54 €	0-48 / 48	230	
1298	MAZO 3 CUCHARA MESA film 3 table spoon, film 3 cuillère table, film 3 cucchiaio tavola, film 3 tafellöffel	5,54 €	0-48 / 48	209	3
1299	MAZO 3 TENEDOR MESA film 3 table fork, film 3 fourchette table, film 3 forchetta tavola, film 3 tafelgabel	5,54 €	0-48 / 48	210	3
1315	MAZO 2 CUCHILLO POSTRE film 2 dessert knife, film 2 couteau dessert, film 2 coltello frutta, film 2 dessertmesser	5,54 €	0-48 / 48	200	
1316	MAZO 3 CUCHARA POSTRE film 3 dessert spoon, film 3 cuillère à dessert, film 3 cucchiaio frutta, film 3 dessertlöffel	5,54 €	0-48 / 48	178	2,5
1317	MAZO 3 TENEDOR POSTRE film 3 dessert fork, film 3 fourchette à dessert, film 3 forchetta frutta, film 3 dessertgabel	5,54 €	0-48 / 48	183	2,5
11931	MAZO 6 TENEDOR LUNCH film 6 cake fork, film 6 fourchette gâteau, film 6 forchetta dolce, film 6 kuchengabel	5,55 €	0-48 / 48	178	2
1301	MAZO 6 CUCHARA CAFÉ film 6 tea spoon, film 6 cuillère café, film 6 cucchiaio caffè, film 6 kaffeelöffel	5,54 €	0-48 / 48	138	2
1302	MAZO 6 CUCHARA MOKA film 6 coffee/moka spoon, film 6 cuillère moka, film 6 cucchiaio moka, film 6 mokkalöffel	5,54 €	0-48 / 48	117	2

SEVILLA S

INOX Nickel Free 18% / 1,8mm / Mirror

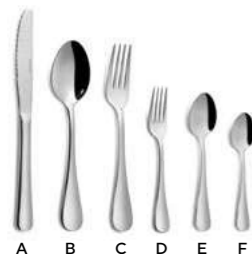

REF.	Descripción	€	UE/MOQ	▶ mm	✂ mm
A 4712	Cuchillo Mesa Microdentado Table Knife Micro, Couteau Table Micro, Coltello Tavola Micro, Tafelmesser Micro	1,71 €	12-120 / 12	224	
B 0451	Cuchara Mesa Table Spoon, Cuillère Table, Cucchiaino Tavola, Tafellöffel	0,99 €	12-120 / 12	193	1,5
C 0452	Tenedor Mesa Table Fork, Fourchette Table, Forchetta Tavola, Tafelgabel	0,99 €	12-120 / 12	190	1,8
D 0453	Tenedor Lunch Cake Fork, Fourchette Gâteau, Forchetta Dolce, Kuchengabel	0,66 €	12-120 / 12	143	1,5
E 0454	Cuchara Café Tea Spoon, Cuillère Café, Cucchiaino Caffé, Kaffeelöffel	0,66 €	12-120 / 12	140	1,5
F 0455	Cuchara Moka Coffee/Moka Spoon, Cuillère Moka, Cucchiaino Moka, Mokkalöffel	0,62 €	12-120 / 12	120	1,2
M3950	Mazo 2 Cuchillo Mesa Micro Film 2 Table Knife Micro, Film 2 Couteau Table Micro, Film 2 Coltello Tavola Micro, Film 2 Tafelmesser Micro	3,74 €	12-120 / 12	224	
M4306	Mazo 3 Cuchara Mesa Film 3 Table Spoon, Film 3 Cuillère Table, Film 3 Cucchiaino Tavola, Film 3 Tafellöffel	3,74 €	12-120 / 12	193	1,5
M4307	Mazo 3 Tenedor Mesa Film 3 Table Fork, Film 3 Fourchette Table, Film 3 Forchetta Tavola, Film 3 Tafelgabel	3,74 €	12-120 / 12	190	1,8
M4755	Mazo 6 Tenedor Lunch Film 6 Cake Fork, Film 6 Fourchette Gâteau, Film 6 Forchetta Dolce, Film 6 Kuchengabel	3,74 €	12-120 / 12	143	1,5
M4756	Mazo 6 Cuchara Café Film 6 Tea Spoon, Film 6 Cuillère Café, Film 6 Cucchiaino Caffé, Film 6 Kaffeelöffel	3,74 €	12-120 / 12	140	1,5
M4757	Mazo 6 Cuchara Moka Film 6 Coffee/Moka Spoon, Film 6 Cuillère Moka, Film 6 Cucchiaino Moka, Film 6 Mokkalöffel	3,74 €	12-120 / 12	120	1,2
3950	Corbata 2 Cuchillo Mesa Eco Micro Tie 2 Table Knife Eco Micro, Cavalier 2 Couteau Table Eco Micro, Cravatta 2 Coltello Tavola Eco Micro, Krawatte 2 Tafelmesser Eco Micro	3,85 €	0-48 / 48	224	
4306	Corbata 3 Cuchara Mesa Tie 3 Table Spoon, Cavalier 3 Cuillère Table, Cravatta 3 Cucchiaino Tavola, Krawatte 3 Takkellöffel	3,85 €	0-48 / 48	193	1,5
4307	Corbata 3 Tenedor Mesa Tie 3 Table Fork, Cavalier 3 Fourchette Table, Cravatta 3 Forchetta Tavola, Krawatte 3 Tafelgabel	3,85 €	0-48 / 48	190	1,8
4755	Corbata 6 Tenedor Lunch Tie 6 Cake Fork, Cavalier 6 Fourchette Gâteau, Cravatta 6 Forchetta Dolce, Krawatte 6 Kuchengabel	3,85 €	0-48 / 48	143	1,5
4756	Corbata 6 Cuchara Café Tie 6 Tea Spoon, Cavalier 6 Cuillère Café, Cravatta 6 Cucchiaino Caffé, Krawatte 6 Kaffeelöffel	3,85 €	0-48 / 48	140	1,5
4757	Corbata 6 Cuchara Moka Tie 6 Moka Spoon, Cavalier 6 Cuillère Moka, Cravatta 6 Cucchiaino Moka, Krawatte 6 Mokkalöffel	3,85 €	0-48 / 48	120	1,2
4885	24 Piezas 24 Pieces, Écrin 24 Pièces, Bauletto 24 Pz., 24 Stück	28,74 €	1-4 / 1		1,8
4999	24 Piezas Con Chuletero 24 Pieces + Stak Knife, Écrin 24 Pièces + C.steak, Bauletto 24 Pz. + Bistecca, 24 Stück + Steakmesser	32,52 €	1-4 / 1		1,8

SEVILLA VINTAGE

INOX Nickel Free 18% / 2,5mm / Vintage

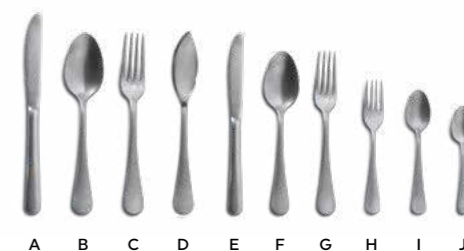

REF.	Descripción	€	UE/MOQ	▶ mm	✂ mm
A 7425	Cuchillo Mesa Table Knife, Couteau Table, Coltello Tavola, Tafelmesser	2,05 €	12-120 / 12	225	
B 7426	Cuchara Mesa Table Spoon, Cuillère Table, Cucchiaino Tavola, Tafellöffel	1,43 €	12-120 / 12	198	2,5
C 7427	Tenedor Mesa Table Fork, Fourchette Table, Forchetta Tavola, Tafelgabel	1,43 €	12-120 / 12	198	2,5
D 8567	Pala Pescado Fish Knife, Couteau Poisson, Coltello Pesce, Fischmesser	1,22 €	12-120 / 12	200	2,5
E 8568	Cuchillo Postre Dessert Knife, Couteau Dessert, Coltello Frutta, Dessertmesser	1,80 €	12-120 / 12	195	
F 8569	Cuchara Postre Dessert Spoon, Cuillère À Dessert, Cucchiaino Frutta, Dessertlöffel	1,13 €	12-120 / 12	185	2,5
G 8570	Tenedor Postre Dessert Fork, Fourchette À Dessert, Forchetta Frutta, Dessertgabel	1,13 €	12-120 / 12	185	2,5
H 11932	Tenedor Lunch Cake Fork, Fourchette Gâteau, Forchetta Dolce, Kuchengabel	0,88 €	12-120 / 12	148	2
I 7429	Cuchara Café Tea Spoon, Cuillère Café, Cucchiaino Caffé, Kaffeelöffel	0,85 €	12-120 / 12	138	2
J 7430	Cuchara Moka Coffee/Moka Spoon, Cuillère Moka, Cucchiaino Moka, Mokkalöffel	0,83 €	12-120 / 12	117	2
7917	24 Piezas 24 Pieces, Écrin 24 Pièces, Bauletto 24 Pz., 24 Stück	43,07 €	1-4 / 1		

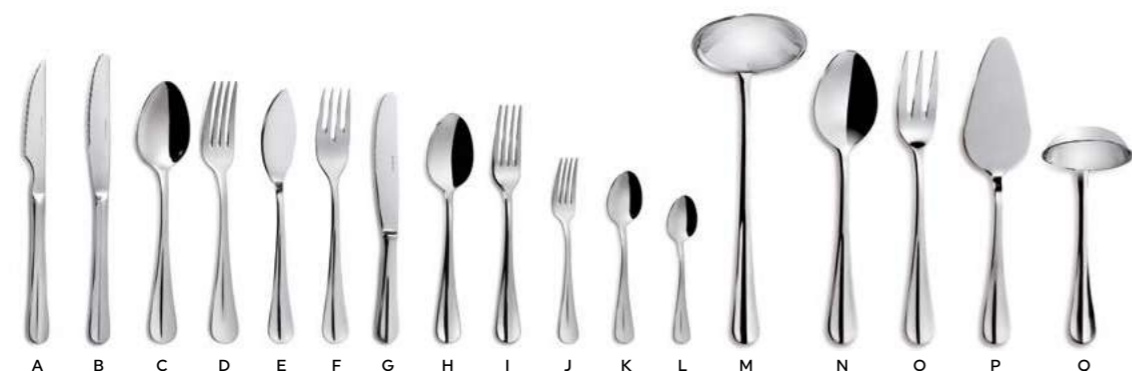

REF.	Descripción	€	UE/MOQ	▶ mm	✂ mm
A 1283	CUCHILLO CHULETERO Steak Knife, Couteau Steak, Coltello Bistecca, Steakmesser	2,49 €	12-120 / 12	223	
B 3522	CUCHILLO MESA Table Knife, Couteau Table, Coltello Tavola, Tafelmesser	2,49 €	12-120 / 12	225	
C 2700	CUCHARA MESA Table Spoon, Cuillère Table, Cucchiaio Tavola, Tafellöffel	1,43 €	12-120 / 12	209	2,5
D 2701	TENEDOR MESA Table Fork, Fourchette Table, Forchetta Tavola, Tafelgabel	1,43 €	12-120 / 12	210	2,5
E 2702	PALA PESCADO Fish Knife, Couteau Poisson, Coltello Pesce, Fischmesser	1,23 €	12-120 / 12	200	2,5
F 2703	TENEDOR PESCADO Fish Fork, Fourchette Poisson, Forchetta Pesce, Fischgabel	1,23 €	12-120 / 12	200	2,5
G 3523	CUCHILLO POSTRE Dessert Knife, Couteau Dessert, Coltello Frutta, Dessertmesser	2,29 €	12-120 / 12	196	
H 2705	CUCHARA POSTRE Dessert Spoon, Cuillère À Dessert, Cucchiaio Frutta, Dessertlöffel	1,13 €	12-120 / 12	178	2,5
I 2706	TENEDOR POSTRE Dessert Fork, Fourchette À Dessert, Forchetta Frutta, Dessertgabel	1,13 €	12-120 / 12	183	2,5
J 11933	TENEDOR LUNCH Cake Fork, Fourchette Gâteau, Forchetta Dolce, Kuchengabel	0,88 €	12-120 / 12	148	2
K 2708	CUCHARA CAFÉ Tea Spoon, Cuillère Café, Cucchiaio Caffé, Kaffeelöffel	0,85 €	12-120 / 12	138	2
L 2709	CUCHARA MOKA Coffee/Moka Spoon, Cuillère Moka, Cucchiaio Moka, Mokkalöffel	0,83 €	12-120 / 12	117	2
M 2303	CAZO SOPA Soup Ladle, Louche À Potage, Mestolo, Suppenkelle	5,78 €	10-50 / 10	260	2,5
N 2304	CUCHARA SERVIR Serving Spoon, Cuillère À Servir, Cucchiaio Servir, Servierlöffel	4,28 €	10-50 / 10	230	2,8
O 2305	TENEDOR SERVIR Serving Fork, Fourchette À Servir, Forchetta Servire, Serviergabel	4,28 €	10-50 / 10	230	2,5
P 2306	PALA REPOSTERÍA Cake Server, Pelle À Tarte, Pala Torta, Tortenheber	4,72 €	10-50 / 10	240	2,7
Q 2307	CAZO SALSAS Sauce Ladle, Cuillère À Sauce, Mestolino Salsa, Soßenkelle	5,67 €	10-50 / 10	170	2,7

REF.	Descripción	€	UE/MOQ	▶ mm	✂ mm
M1462	MAZO 2 CUCHILLO CHULETERO Film 2 Steak Knife, Film 2 Couteau Steak, Film 2 Coltello Bistecca, Film 2 Steakmesser	5,28 €	0-48 / 48	223	
1597	MAZO 3 CUCHARA MESA Film 3 Table Spoon, Film 3 Cuillère Table, Film 3 Cucchiaio Tavola, Film 3 Tafellöffel	5,28 €	0-48 / 48	209	2,5
1598	MAZO 3 TENEDOR MESA Film 3 Table Fork, Film 3 Fourchette Table, Film 3 Forchetta Tavola, Film 3 Tafelgabel	5,28 €	0-48 / 48	210	2,5
M4564	MAZO 2 CUCHILLO POSTRE Film 2 Dessert Knife, Film 2 Couteau Dessert, Film 2 Coltello Frutta, Film 2 Dessertmesser	5,28 €	0-48 / 48	196	
1601	MAZO 3 CUCHARA POSTRE Film 3 Dessert Spoon, Film 3 Cuillère À Dessert, Film 3 Cucchiaio Frutta, Film 3 Dessertlöffel	5,28 €	0-48 / 48	178	2,5
1602	MAZO 3 TENEDOR POSTRE Film 3 Dessert Fork, Film 3 Fourchette À Dessert, Film 3 Forchetta Frutta, Film 3 Dessertgabel	5,28 €	0-48 / 48	183	2,5
11934	MAZO 6 TENEDOR LUNCH Film 6 Cake Fork, Film 6 Fourchette Gâteau, Film 6 Forchetta Dolce, Film 6 Kuchengabel	5,28 €	0-48 / 48	145	2
1604	MAZO 6 CUCHARA CAFÉ Film 6 Tea Spoon, Film 6 Cuillère Café, Film 6 Cucchiaio Caffé, Film 6 Kaffeelöffel	5,28 €	0-48 / 48	138	2
1605	MAZO 6 CUCHARA MOKA Film 6 Coffee/Moka Spoon, Film 6 Cuillère Moka, Film 6 Cucchiaio Moka, Film 6 Mokkalöffel	5,28 €	0-48 / 48	117	2



GRANADA S

INOX Nickel Free 18% / 1,8mm / Mirror

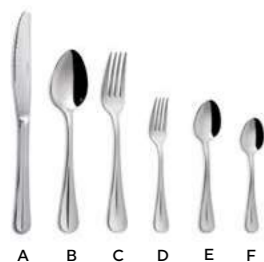

GRANADA S

INOX Nickel Free 18% / 1,8mm / Mirror



REF.	Descripción	€	UE/MOQ	▶ mm	✂ mm
A 4632	CUCHILLO MESA table knife, couteau table, coltello tavola, tafelmesser	1,71 €	12-120 / 12	224	
B 0424	CUCHARA MESA table spoon, cuillère table, cucchiaio tavola, tafellöffel	0,99 €	12-120 / 12	193	1,5
C 0425	TENEDOR MESA table fork, fourchette table, forchetta tavola, tafelgabel	0,99 €	12-120 / 12	190	1,8
D 0426	TENEDOR LUNCH cake fork, fourchette gâteau, forchetta dolce, kuchengabel	0,66 €	12-120 / 12	143	1,5
E 0427	CUCHARA CAFÉ tea spoon, cuillère café, cucchiaio caffè, kaffeelöffel	0,66 €	12-120 / 12	140	1,5
F 0428	CUCHARA MOKA coffee/moka spoon, cuillère moka, cucchiaio moka, mokkalöffel	0,62 €	12-120 / 12	120	1,2
8083	MAZO 2 CUCHILLO MESA film 2 knife, film 2 couteau, film 2 coltello, film 2 messer	3,74 €	0-48 / 48	224	
8084	MAZO 3 CUCHARA MESA film 3 table spoon, film 3 cuillère table, film 3 cucchiaio tavola, film 3 tafellöffel	3,74 €	0-48 / 48	193	1,5
8085	MAZO 3 TENEDOR MESA film 3 table fork, film 3 fourchette table, film 3 forchetta tavola, film 3 tafelgabel	3,74 €	0-48 / 48	190	1,8
8086	MAZO 6 TENEDOR LUNCH film 6 cake fork, film 6 fourchette gâteau, film 6 forchetta dolce, film 6 kuchengabel	3,74 €	0-48 / 48	143	1,5
8087	MAZO 6 CUCHARA CAFÉ film 6 tea spoon, film 6 cuillère café, film 6 cucchiaio caffè, film 6 kaffeelöffel	3,74 €	0-48 / 48	140	1,5
8088	MAZO 6 CUCHARA MOKA film 6 coffee/moka spoon, film 6 cuillère moka, film 6 cucchiaio moka, film 6 mokkalöffel	3,74 €	0-48 / 48	120	1,2
5107	CORBATA 2 CUCHILLO MESA Tie 2 table knife, cavalier 2 couteau table, cravatta 2 coltello tavola, krawatte 2 tafelmesser	3,85 €	0-48 / 48	224	
4623	CORBATA 3 CUCHARA MESA Tie 3 table spoon, cavalier 3 cuillère table, cravatta 3 cucchiaio tavola, krawatte 3 takkellöffel	3,85 €	0-48 / 48	193	1,5
4624	CORBATA 3 TENEDOR MESA Tie 3 table fork, cavalier 3 fourchette table, cravatta 3 forchetta tavola, krawatte 3 tafelgabel	3,85 €	0-48 / 48	190	1,8
3515	CORBATA 6 TENEDOR LUNCH Tie 6 cake fork, cavalier 6 fourchette gâteau, cravatta 6 forchetta dolce, krawatte 6 kuchengabel	3,85 €	0-48 / 48	143	1,5
3516	CORBATA 6 CUCHARA CAFÉ Tie 6 tea spoon, cavalier 6 cuillère café, cravatta 6 cucchiaio caffè, krawatte 6 kaffeelöffel	3,85 €	0-48 / 48	140	1,5
3517	CORBATA 6 CUCHARA MOKA Tie 6 moka spoon, cavalier 6 cuillère moka, cravatta 6 cucchiaio moka, krawatte 6 mokkalöffel	3,85 €	0-48 / 48	120	1,2



REF.	Descripción	€	UE/MOQ	▶ mm	✂ mm
4884	24 PIEZAS 24 pieces, écrin 24 pièces, bauletto 24 pz., 24 stück	28,74 €	1-4 / 1		





REF.	Descripción	€	UE/MOQ	▶ mm	✂ mm
A 2396	Cuchillo Chuletero Steak Knife, Couteau Steak, Coltello Bistecca, Steakmesser	2,48 €	12-120 / 12	223	
B 2338	Cuchillo Mesa Table Knife, Couteau Table, Coltello Tavola, Tafelmesser	2,48 €	12-120 / 12	222	
C 2632	Cuchara Mesa Table Spoon, Cuillère Table, Cucchiaio Tavola, Tafellöffel	1,65 €	12-120 / 12	204	2,5
D 2633	Tenedor Mesa Table Fork, Fourchette Table, Forchetta Tavola, Tafelgabel	1,65 €	12-120 / 12	210	2,5
E 2634	Pala Pescado Fish Knife, Couteau Poisson, Coltello Pesce, Fischmesser	1,56 €	12-120 / 12	200	2,5
F 2635	Tenedor Pescado Fish Fork, Fourchette Poisson, Forchetta Pesce, Fischgabel	1,56 €	12-120 / 12	195	2,5
G 2511	Cuchillo Postre Dessert Knife, Couteau Dessert, Coltello Frutta, Dessertmesser	2,09 €	12-120 / 12	196	
H 2637	Cuchara Postre Dessert Spoon, Cuillère À Dessert, Cucchiaio Frutta, Dessertlöffel	1,56 €	12-120 / 12	178	2,5
I 2638	Tenedor Postre Dessert Fork, Fourchette À Dessert, Forchetta Frutta, Dessertgabel	1,56 €	12-120 / 12	183	2,5
J 11928	Tenedor Lunch Cake Fork, Fourchette Gâteau, Forchetta Dolce, Kuchengabel	0,96 €	12-120 / 12	148	2
K 2640	Cuchara Café Tea Spoon, Cuillère Café, Cucchiaio Caffé, Kaffeelöffel	0,95 €	12-120 / 12	138	2
L 2641	Cuchara Moka Coffee/Moka Spoon, Cuillère Moka, Cucchiaio Moka, Mokkalöffel	0,92 €	12-120 / 12	117	2
M 2298	Cazo Sopa Soup Ladle, Louche À Potage, Mestolo, Suppenkelle	5,78 €	10-50 / 10	260	2,5
N 2040	Cuchara Servir Serving Spoon, Cuillère À Servir, Cucchiaio Servir, Servierlöffel	4,24 €	10-50 / 10	240	2,5
O 2300	Tenedor Servir Serving Fork, Fourchette À Servir, Forchetta Servire, Serviergabel	4,24 €	10-50 / 10	230	2,5
P 2301	Pala Repostería Cake Server, Pelle À Tarte, Pala Torta, Tortenheber	4,71 €	10-50 / 10	240	2,5
Q 2302	Cazo Salsa Sauce Ladle, Cuillère À Sauce, Mestolino Salsa, Soßenkelle	6,50 €	10-50 / 10	170	2,7

REF.	Descripción	€	UE/MOQ	▶ mm	✂ mm
A M2397	Mazo 2 Cuchillo Chuletero Film 2 Steak Knife, Film 2 Couteau Steak, Film 2 Coltello Bistecca, Film 2 Steakmesser	5,23 €	0-48 / 48	223	
C 1635	Mazo 3 Cuchara Mesa Film 3 Table Spoon, Film 3 Cuillère Table, Film 3 Cucchiaio Tavola, Film 3 Tafellöffel	5,23 €	0-48 / 48	209	2,5
D 1642	Mazo 3 Tenedor Mesa Film 3 Table Fork, Film 3 Fourchette Table, Film 3 Forchetta Tavola, Film 3 Tafelgabel	5,23 €	0-48 / 48	210	2,5
G M4591	Mazo 2 Cuchillo Postre Film 2 Dessert Knife, Film 2 Couteau Dessert, Film 2 Coltello Frutta, Film 2 Dessertmesser	5,23 €	0-48 / 48	200	
H 1644	Mazo 3 Cuchara Postre Film 3 Dessert Spoon, Film 3 Cuillère À Dessert, Film 3 Cucchiaio Frutta, Film 3 Dessertlöffel	5,23 €	0-48 / 48	178	2,5
I 1646	Mazo 3 Tenedor Postre Film 3 Dessert Fork, Film 3 Fourchette À Dessert, Film 3 Forchetta Frutta, Film 3 Dessertgabel	5,23 €	0-48 / 48	183,	2,5
J 11929	Mazo 6 Tenedor Lunch Film 6 Cake Fork, Film 6 Fourchette Gâteau, Film 6 Forchetta Dolce, Film 6 Kuchengabel	5,23 €	0-48 / 48	148	2
K 1648	Mazo 6 Cuchara Café Film 6 Tea Spoon, Film 6 Cuillère Café, Film 6 Cucchiaio Caffé, Film 6 Kaffeelöffel	5,23 €	0-48 / 48	138	2
L 1649	Mazo 6 Cuchara Moka Film 6 Coffee/Moka Spoon, Film 6 Cuillère Moka, Film 6 Cucchiaio Moka, Film 6 Mokkalöffel	5,23 €	0-48 / 48	117	2



BILBAO S

INOX Nickel Free 18% / 1,8mm / Mirror



A B C D E F



OLYMPIA

INOX Nickel Free 18% / 1,8mm / Mirror



A B C D E F



REF.	Descripción	€	UE/MOQ	▶ mm	✂ mm
A 1623	Cuchillo Mesa Table Knife, Couteau Table, Coltello Tavola, Tafelmesser	1,71 €	12-120 / 12	224	
B 3130	Cuchara Mesa Table Spoon, Cuillère Table, Cucchiaio Tavola, Tafellöffel	0,99 €	12-120 / 12	193	1,5
C 3131	Tenedor Mesa Table Fork, Fourchette Table, Forchetta Tavola, Tafelgabel	0,99 €	12-120 / 12	190	1,8
D 3814	Tenedor Lunch Cake Fork, Fourchette Gâteau, Forchetta Dolce, Kuchengabel	0,66 €	12-120 / 12	143	1,5
E 3812	Cuchara Café Tea Spoon, Cuillère Café, Cucchiaio Caffé, Kaffeelöffel	0,66 €	12-120 / 12	140	1,5
F 3813	Cuchara Moka Coffee/Moka Spoon, Cuillère Moka, Cucchiaio Moka, Mokkalöffel	0,62 €	12-120 / 12	120	1,2
M0010	Mazo 2 Cuchillo Mesa Film 2 Knife, Film 2 Couteau, Film 2 Coltello, Film 2 Messer	3,74 €	0-48 / 48	224	
M3435	Mazo 3 Cuchara Mesa Film 3 Table Spoon, Film 3 Cuillère Table, Film 3 Cucchiaio Tavola, Film 3 Tafellöffel	3,74 €	0-48 / 48	193	1,5
M3970	Mazo 3 Tenedor Mesa Film 3 Table Fork, Film 3 Fourchette Table, Film 3 Forchetta Tavola, Film 3 Tafelgabel	3,74 €	0-48 / 48	190	1,8
M4540	Mazo 6 Tenedor Lunch Film 6 Cake Fork, Film 6 Fourchette Gâteau, Film 6 Forchetta Dolce, Film 6 Kuchengabel	3,74 €	0-48 / 48	143	1,5
M4541	Mazo 6 Cuchara Café Film 6 Tea Spoon, Film 6 Cuillère Café, Film 6 Cucchiaio Caffé, Film 6 Kaffeelöffel	3,74 €	0-48 / 48	140	1,5
M4542	Mazo 6 Cuchara Moka Film 6 Coffee/Moka Spoon, Film 6 Cuillère Moka, Film 6 Cucchiaio Moka, Film 6 Mokkalöffel	3,74 €	0-48 / 48	120	1,2
0010	Corbata 2 Cuchillo Mesa Tie 2 Table Knife, Cavalier 2 Couteau Table, Cravatta 2 Coltello Tavola, Krawatte 2 Tafelmesser	3,85 €	0-48 / 48	224	
3435	Corbata 3 Cuchara Mesa Tie 3 Table Spoon, Cavalier 3 Cuillère Table, Cravatta 3 Cucchiaio Tavola, Krawatte 3 Takkellöffel	3,85 €	0-48 / 48	193	1,5
3970	Corbata 3 Tenedor Mesa Tie 3 Table Fork, Cavalier 3 Fourchette Table, Cravatta 3 Forchetta Tavola, Krawatte 3 Tafelgabel	3,85 €	0-48 / 48	190	1,8
4540	Corbata 6 Tenedor Lunch Tie 6 Cake Fork, Cavalier 6 Fourchette Gâteau, Cravatta 6 Forchetta Dolce, Krawatte 6 Kuchengabel	3,85 €	0-48 / 48	143	1,5
4541	Corbata 6 Cuchara Café Tie 6 Tea Spoon, Cavalier 6 Cuillère Café, Cravatta 6 Cucchiaio Caffé, Krawatte 6 Kaffeelöffel	3,85 €	0-48 / 48	140	1,5
4542	Corbata 6 Cuchara Moka Tie 6 Moka Spoon, Cavalier 6 Cuillère Moka, Cravatta 6 Cucchiaio Moka, Krawatte 6 Mokkalöffel	3,85 €	0-48 / 48	120	1,2
2455	24 Piezas 24 Pieces, Ecrin 24 Pièces, Bauletto 24 Pz., 24 Stück	28,74 €	1-4 / 1		1,8

REF.	Descripción	€	UE/MOQ	▶ mm	✂ mm
A 1934	Corbata 2 Cuchillo Mesa Tie 2 Table Knife, Cavalier 2 Couteau Table, Cravatta 2 Coltello Tavola, Krawatte 2 Tafelmesser	3,85 €	0-48 / 48	224	
B 3976	Corbata 3 Cuchara Mesa Tie 3 Table Spoon, Cavalier 3 Cuillère Table, Cravatta 3 Cucchiaio Tavola, Krawatte 3 Takkellöffel	3,85 €	0-48 / 48	193	1,5
C 3771	Corbata 3 Tenedor Mesa Tie 3 Table Fork, Cavalier 3 Fourchette Table, Cravatta 3 Forchetta Tavola, Krawatte 3 Tafelgabel	3,85 €	0-48 / 48	190	1,8
D 4539	Corbata 6 Tenedor Lunch Tie 6 Cake Fork, Cavalier 6 Fourchette Gâteau, Cravatta 6 Forchetta Dolce, Krawatte 6 Kuchengabel	3,85 €	0-48 / 48	143	1,5
E 2555	Corbata 6 Cuchara Café Tie 6 Tea Spoon, Cavalier 6 Cuillère Café, Cravatta 6 Cucchiaio Caffé, Krawatte 6 Kaffeelöffel	3,85 €	0-48 / 48	140	1,5
F 4556	Corbata 6 Cuchara Moka Tie 6 Moka Spoon, Cavalier 6 Cuillère Moka, Cravatta 6 Cucchiaio Moka, Krawatte 6 Mokkalöffel	3,85 €	0-48 / 48	120	1,2
2458	24 Piezas 24 Pieces, Ecrin 24 Pièces, Bauletto 24 Pz., 24 Stück	28,74 €	1-4 / 1		1,8

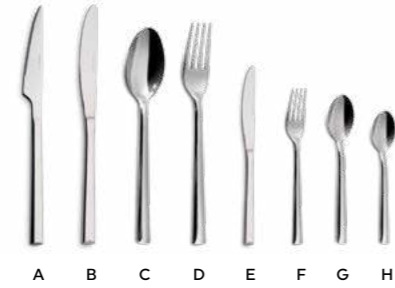

REF.	Descripción	€	UE/MOQ	▶ mm	✂ mm
A 2454	Cuchillo Chuletero Steak Knife, Couteau Steak, Coltello Bistecca, Steakmesser	1,81 €	12-120 / 12	225	
B 1613	Cuchillo Mesa Eco Table Knife, Couteau Table, Coltello Tavola, Tafelmesser	2,22 €	12-120 / 12	225	
C 2816	Cuchara Mesa Table Spoon, Cuillère Table, Cucchiaio Tavola, Tafellöffel	1,26 €	12-120 / 12	203	1,5
D 2817	Tenedor Mesa Table Fork, Fourchette Table, Forchetta Tavola, Tafelgabel	1,26 €	12-120 / 12	208	2
E 0021	Cuchillo Lunch Cake Knife, Couteau Gâteau, Coltello Dolce, Kuchenmesser	1,46 €	12-120 / 12	165	
F 1825	Tenedor Lunch Cake Fork, Fourchette Gâteau, Forchetta Dolce, Kuchengabel	0,69 €	12-120 / 12	145	1,5
G 1826	Cuchara Café Tea Spoon, Cuillère Café, Cucchiaio Caffé, Kaffeelöffel	0,69 €	12-120 / 12	140	1,5
H 1827	Cuchara Moka Coffee/Moka Spoon, Cuillère Moka, Cucchiaio Moka, Mokkalöffel	0,60 €	12-120 / 12	125	1,5
M9332	Mazo 2 Cuchillo Chuletero Film 2 Steak Knife, Film 2 Couteau Steak, Film 2 Coltello Bistecca, Film 2 Steakmesser	3,90 €	0-48 / 48	225	
1607	Mazo 3 Cuchara Mesa Film 3 Table Spoon, Film 3 Cuillère Table, Film 3 Cucchiaio Tavola, Film 3 Tafellöffel	3,90 €	0-48 / 48	205	1,5
1608	Mazo 3 Tenedor Mesa Film 3 Table Fork, Film 3 Fourchette Table, Film 3 Forchetta Tavola, Film 3 Tafelgabel	3,90 €	0-48 / 48	208	2
1887	Mazo 6 Tenedor Lunch Film 6 Cake Fork, Film 6 Fourchette Gâteau, Film 6 Forchetta Dolce, Film 6 Kuchengabel	3,90 €	0-48 / 48	145	1,5
1610	Mazo 6 Cuchara Café Film 6 Tea Spoon, Film 6 Cuillère Café, Film 6 Cucchiaio Caffé, Film 6 Kaffeelöffel	3,90 €	0-48 / 48	140	1,5
1611	Mazo 6 Cuchara Moka Film 6 Coffee/Moka Spoon, Film 6 Cuillère Moka, Film 6 Cucchiaio Moka, Film 6 Mokkalöffel	3,90 €	0-48 / 48	125	1,5
2660	Corbata 2 Cuchillo Chuletero Tie 2 Steak Knife, Cavalier 2 Couteau Steak, Cravatta 2 Coltello Bistecca, Krawatte 2 Steakmesser	4,01 €	0-48 / 48	225	
2509	Corbata 3 Cuchara Mesa Tie 3 Table Spoon, Cavalier 3 Cuillère Table, Cravatta 3 Cucchiaio Tavola, Krawatte 3 Takkellöffel	4,01 €	0-48 / 48	205	1,5
2510	Corbata 3 Tenedor Mesa Tie 3 Table Fork, Cavalier 3 Fourchette Table, Cravatta 3 Forchetta Tavola, Krawatte 3 Tafelgabel	4,01 €	0-48 / 48	208	2
1889	Corbata 6 Tenedor Lunch Tie 6 Cake Fork, Cavalier 6 Fourchette Gâteau, Cravatta 6 Forchetta Dolce, Krawatte 6 Kuchengabel	4,01 €	0-48 / 48	145	1,5
2513	Corbata 6 Cuchara Café Tie 6 Tea Spoon, Cavalier 6 Cuillère Café, Cravatta 6 Cucchiaio Caffé, Krawatte 6 Kaffeelöffel	4,01 €	0-48 / 48	140	1,5
1890	Corbata 6 Cuchara Moka Tie 6 Moka Spoon, Cavalier 6 Cuillère Moka, Cravatta 6 Cucchiaio Moka, Krawatte 6 Mokkalöffel	4,01 €	0-48 / 48	125	1,5



REF.	Descripción	€	UE/MOQ	▶ mm	✂ mm
2515	24 Piezas 24 Pieces, Écrin 24 Pièces, Bauletto 24 Pz., 24 Stück	31,01 €	1-4 / 1		2



LUNA

INOX Nickel Free 18% / 1,8mm / Mirror



A B C D E F



B C D E



A

REF.	Descripción	€	UE/MOQ	▶ mm	✂ mm
A 7142	Cuchillo Mesa Table Knife, Couteau Table, Coltello Tavola, Tafelmesser	1,76 €	12-120 / 12	224	
B 7143	Cuchara Mesa Table Spoon, Cuillère Table, Cucchiaio Tavola, Tafellöffel	1,02 €	12-120 / 12	193	1,5
C 7144	Tenedor Mesa Table Fork, Fourchette Table, Forchetta Tavola, Tafelgabel	1,02 €	12-120 / 12	190	1,8
D 7145	Tenedor Lunch Cake Fork, Fourchette Gâteau, Forchetta Dolce, Kuchengabel	0,66 €	12-120 / 12	143	1,5
E 7146	Cuchara Café Tea Spoon, Cuillère Café, Cucchiaio Caffé, Kaffeelöffel	0,66 €	12-120 / 12	140	1,5
F 7147	Cuchara Moka Coffee/Moka Spoon, Cuillère Moka, Cucchiaio Moka, Mokkalöffel	0,62 €	12-120 / 12	120	1,2
7148	Mazo 2 Cuchillo Mesa Film 2 Knife, Film 2 Couteau, Film 2 Coltello, Film 2 Messer	3,74 €	0-48 / 48	224	
7149	Mazo 3 Cuchara Mesa Film 3 Table Spoon, Film 3 Cuillère Table, Film 3 Cucchiaio Tavola, Film 3 Tafellöffel	3,74 €	0-48 / 48	193	1,5
7150	Mazo 3 Tenedor Mesa Film 3 Table Fork, Film 3 Fourchette Table, Film 3 Forchetta Tavola, Film 3 Tafelgabel	3,74 €	0-48 / 48	190	1,8
7151	Mazo 6 Tenedor Lunch Film 6 Cake Fork, Film 6 Fourchette Gâteau, Film 6 Forchetta Dolce, Film 6 Kuchengabel	3,74 €	0-48 / 48	143	1,5
7152	Mazo 6 Cuchara Café Film 6 Tea Spoon, Film 6 Cuillère Café, Film 6 Cucchiaio Caffé, Film 6 Kaffeelöffel	3,74 €	0-48 / 48	140	1,5
7153	Mazo 6 Cuchara Moka Film 6 Coffee/Moka Spoon, Film 6 Cuillère Moka, Film 6 Cucchiaio Moka, Film 6 Mokkalöffel	3,74 €	0-48 / 48	120	1,2
7155	Corbata 2 Cuchillo Mesa Tie 2 Table Knife, Cavalier 2 Couteau Table, Cravatta 2 Coltello Tavola, Krawatte 2 Tafelmesser	3,85 €	0-48 / 48	224	
7156	Corbata 3 Cuchara Mesa Tie 3 Table Spoon, Cavalier 3 Cuillère Table, Cravatta 3 Cucchiaio Tavola, Krawatte 3 Takkellöffel	3,85 €	0-48 / 48	193	1,5
7157	Corbata 3 Tenedor Mesa Tie 3 Table Fork, Cavalier 3 Fourchette Table, Cravatta 3 Forchetta Tavola, Krawatte 3 Tafelgabel	3,85 €	0-48 / 48	190	1,8
7158	Corbata 6 Tenedor Lunch Tie 6 Cake Fork, Cavalier 6 Fourchette Gâteau, Cravatta 6 Forchetta Dolce, Krawatte 6 Kuchengabel	3,85 €	0-48 / 48	143	1,5
7159	Corbata 6 Cuchara Café Tie 6 Tea Spoon, Cavalier 6 Cuillère Café, Cravatta 6 Cucchiaio Caffé, Krawatte 6 Kaffeelöffel	3,85 €	0-48 / 48	140	1,5
7160	Corbata 6 Cuchara Moka Tie 6 Moka Spoon, Cavalier 6 Cuillère Moka, Cravatta 6 Cucchiaio Moka, Krawatte 6 Mokkalöffel	3,85 €	0-48 / 48	120	1,2
7154	24 Piezas 24 Pieces, Écrin 24 Pièces, Bauletto 24 Pz., 24 Stück	28,74 €	1-4 / 1		1,8

REF.	Descripción	€	UE/MOQ	▶ mm	✂ mm
A 12006	Cuchillo Chuletero Europa Europa Steak Knife, Couteau Steakeuropa, Coltello Bistecca Europa, Steakmesser Europa	2,05 €	12-120 / 12	215	
B 5497	Cuchillo Mesa Microdentado Table Knife, Couteau Table, Coltello Tavola, Tafelmesser	1,77 €	12-120 / 12	214	2,5
C 6320	Cuchara Mesa Europa XI Europa XI Table Spoon, Europa XI Cuillère Table, Cucchiaio Tavola Europa XI, Tafellöffel Europa XI	1,32 €	12-120 / 12	195	2,5
D 6321	Tenedor Mesa Europa XI Europa XI Table Fork, Europa XI Fourchette Table, Forchetta Tavola Europa XI, Tafelgabel Europa XI	1,32 €	12-120 / 12	195	1,5
E 2686	Cuchara Café Tea Spoon, Cuillère Café, Cucchiaio Caffé, Kaffeelöffel	0,72 €	12-120 / 12	140	

HOTEL EXTRA M

INOX Nickel Free 18% / 2mm / Mirror



HOTEL EXTRA M

INOX Nickel Free 18% / 2mm / Mirror



REF.	Descripción	€	UE/MOQ	▶ mm	✂ mm
A 2454	Cuchillo Chuletero Steak Knife, Couteau Steak, Coltello Bistecca, Steakmesser	1,81 €	12-120 / 12	225	
B 5497	Cuchillo Mesa Microdentado Table Knife Micro, Couteau Table Micro, Coltello Tavola Micro, Tafelmesser Micro	1,77 €	12-120 / 12	215	
C 0013	Cuchillo Mesa Table Knife, Couteau Table, Coltello Tavola, Tafelmesser	1,68 €	12-120 / 12	214	
D 2679	Cuchara Mesa Table Spoon, Cuillère Table, Cucchiato Tavola, Tafellöffel	1,00 €	12-120 / 12	195	2
E 2680	Tenedor Mesa Table Fork, Fourchette Table, Forchetta Tavola, Tafelgabel	1,00 €	12-120 / 12	196	2
F 2681	Pala Pescado Fish Knife, Couteau Poisson, Coltello Pesce, Fischmesser	0,88 €	12-120 / 12	190	1,5
G 2682	Tenedor Pescado Fish Fork, Fourchette Poisson, Forchetta Pesce, Fischgabel	0,88 €	12-120 / 12	180	1,5
H 0018	Cuchillo Postre Dessert Knife, Couteau Dessert, Coltello Frutta, Dessertmesser	1,63 €	12-120 / 12	190	
I 2683	Cuchara Postre Dessert Spoon, Cuillère Dessert, Cucchiato Frutta, Dessertlöffel	0,93 €	12-120 / 12	177	1,5
J 2684	Tenedor Postre Dessert Fork, Fourchette Dessert, Forchetta Frutta, Dessertgabel	0,93 €	12-120 / 12	180	1,5
K 0021	Cuchillo Lunch Cake Knife, Couteau Gâteau, Coltello Dolce, Kuchenmesser	1,46 €	12-120 / 12	165	
L 2685	Tenedor Lunch Cake Fork, Fourchette Gâteau, Forchetta Dolce, Kuchengabel	0,72 €	12-120 / 12	150	1,5
M 2686	Cuchara Café Tea Spoon, Cuillère Café, Cucchiato Caffé, Kaffeelöffel	0,72 €	12-120 / 12	140	1,5
N 2687	Cuchara Moka Coffee/Moka Spoon, Cuillère Moka, Cucchiato Moka, Mokkalöffel	0,60 €	12-120 / 12	110	1,2
O 2688	Cuchara Refresco Soda Spoon, Cuillère Mazagran, Cucchiato Bibita, Longdrinklöffel	0,93 €	12-120 / 12	205	1,5
P 3092	Cuchara Helado Ice Cream Spoon, Cuillère À Glace, Cucchiato Gelato, Eiscremelöffel	0,87 €	12-120 / 12	132	1,2
Q 2689	Cazo Sopa Soup Ladle, Louche À Potage, Mestolo, Suppenkelle	7,15 €	10-50 / 10	270	2,6
R 2690	Cuchara Ensalada Salad Spoon, Cuillère À Servir Salade, Cucchiato Servire, Salatlöffel	5,30 €	10-50 / 10	230	2,8
S 2691	Tenedor Ensalada Salad Fork, Fourchette À Servir Salade, Forchetta Servire, Salatgabel	5,30 €	10-50 / 10	235	2,6
T 0031	Pala Repostería Cake Server, Pelle À Tarte, Pala Torta, Tortenheber	5,30 €	10-50 / 10	240	2,5
U 5517	Cazo Salsa Sauce Ladle, Cuillère À Sauce, Mestolino Salsa, Soßenkelle	7,10 €	10-50 / 10	170	2,5

REF.	Descripción	€	UE/MOQ	▶ mm	✂ mm
M5206	Mazo 2 Cuchillo Mesa Film 2 Knife, Film 2 Couteau, Film 2 Coltello, Film 2 Messer	3,90 €	0-48 / 48	215	
M5202	Mazo 3 Cuchara Mesa Film 3 Table Spoon, Film 3 Cuillère Table, Film 3 Cucchiato Tavola, Film 3 Tafellöffel	3,90 €	0-48 / 48	195	1,5
M5203	Mazo 3 Tenedor Mesa Film 3 Table Fork, Film 3 Fourchette Table, Film 3 Forchetta Tavola, Film 3 Tafelgabel	3,90 €	0-48 / 48	196	2
M3036	Mazo 6 Tenedor Lunch Film 6 Cake Fork, Film 6 Fourchette Gâteau, Film 6 Forchetta Dolce, Film 6 Kuchengabel	3,90 €	0-48 / 48	150	1,5
M3037	Mazo 6 Cuchara Café Film 6 Tea Spoon, Film 6 Cuillère Café, Film 6 Cucchiato Caffé, Film 6 Kaffeelöffel	3,90 €	0-48 / 48	140	1,5
M3038	Mazo 6 Cuchara Moka Film 6 Coffee/Moka Spoon, Film 6 Cuillère Moka, Film 6 Cucchiato Moka, Film 6 Mokkalöffe	3,90 €	0-48 / 48	110	1,2
5206	Corbata 2 Cuchillo Mesa Micro Tie 2 Steak Knife Micro, Cavalier 2 Couteau Steak Micro, Cravatta 2 Coltello Bistecca Micro, Krawatte 2 Steakmesser Micro	4,01 €	0-48 / 48	215	
5202	Corbata 3 Cuchara Mesa Tie 3 Table Spoon, Cavalier 3 Cuillère Table, Cravatta 3 Cucchiato Tavola, Krawatte 3 Tackellöffel	4,01 €	0-48 / 48	195	1,5
5203	Corbata 3 Tenedor Mesa Tie 3 Table Fork, Cavalier 3 Fourchette Table, Cravatta 3 Forchetta Tavola, Krawatte 3 Tafelgabel	4,01 €	0-48 / 48	196	1,5
3036	Corbata 6 Tenedor Lunch Tie 6 Cake Fork, Cavalier 6 Fourchette Gâteau, Cravatta 6 Forchetta Dolce, Krawatte 6 Kuchengabel	4,01 €	0-48 / 48	150	1,5
3037	Corbata 6 Cuchara Café Tie 6 Tea Spoon, Cavalier 6 Cuillère Café, Cravatta 6 Cucchiato Caffé, Krawatte 6 Kaffeelöffel	4,01 €	0-48 / 48	140	1,5
3038	Corbata 6 Cuchara Moka Tie 6 Moka Spoon, Cavalier 6 Cuillère Moka, Cravatta 6 Cucchiato Moka, Krawatte 6 Mokkalöffe	4,01 €	0-48 / 48	110	1,2

HOTEL EXTRA ECO

INOX Nickel Free 18% / 1,5mm / Mirror

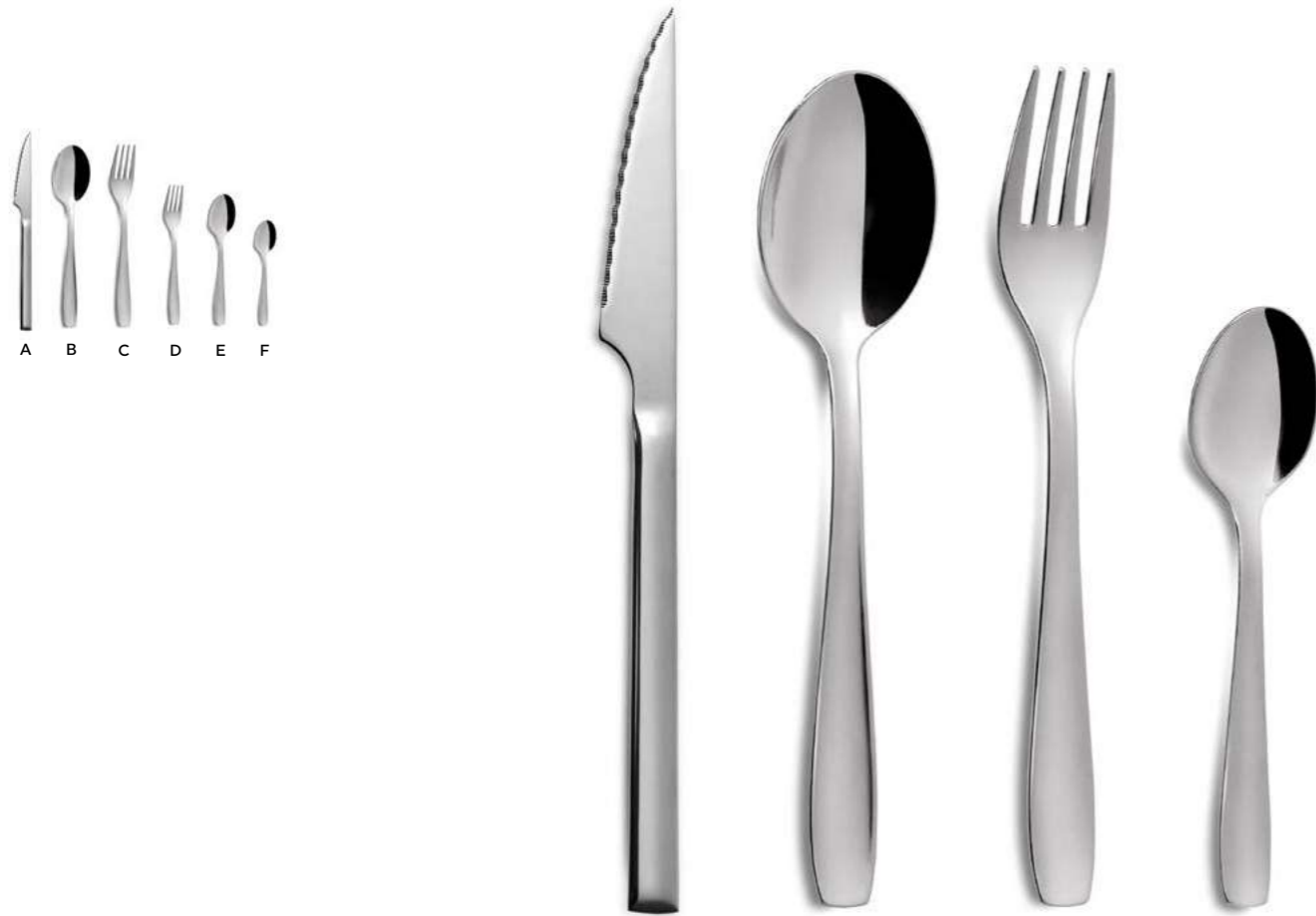

REF.	Descripción	€	UE/MOQ	▶ mm	✂ mm
A 2454	Cuchillo Chuletero Steak Knife, Couteau Steak, Coltello Bistecca, Steakmesser	1,81 €	12-120 / 12	225	
B 8009	Cuchara Mesa Eco Table Spoon Eco, Cuillère Table Eco, Cucchiaio Tavola Eco, Tafellöffel Eco	0,82 €	12-120 / 12	195	1,5
C 8010	Tenedor Mesa Eco Table Fork Eco, Fourchette Table Eco, Forchetta Tavola Eco, Tafelgabel Eco	0,82 €	12-120 / 12	196	1,5
D 0940	Tenedor Lunch Eco Cake Fork Eco, Fourchette Gâteau Eco, Forchetta Dolce Eco, Kuchengabel Eco	0,62 €	12-120 / 12	150	1,2
E 0941	Cuchara Café Eco Tea Spoon Eco, Cuillère Café Eco, Cucchiaio Caffé Eco, Kaffeelöffel Eco	0,62 €	12-120 / 12	140	1,2
F 0942	Cuchara Moka Eco Coffee/Moka Spoon Eco, Cuillère Moka Eco, Cucchiaio Moka Eco, Mokkalöffel Eco	0,52 €	12-120 / 12	110	1

HOTEL

INOX Nickel Free 18% / 1,5mm / Vibrado

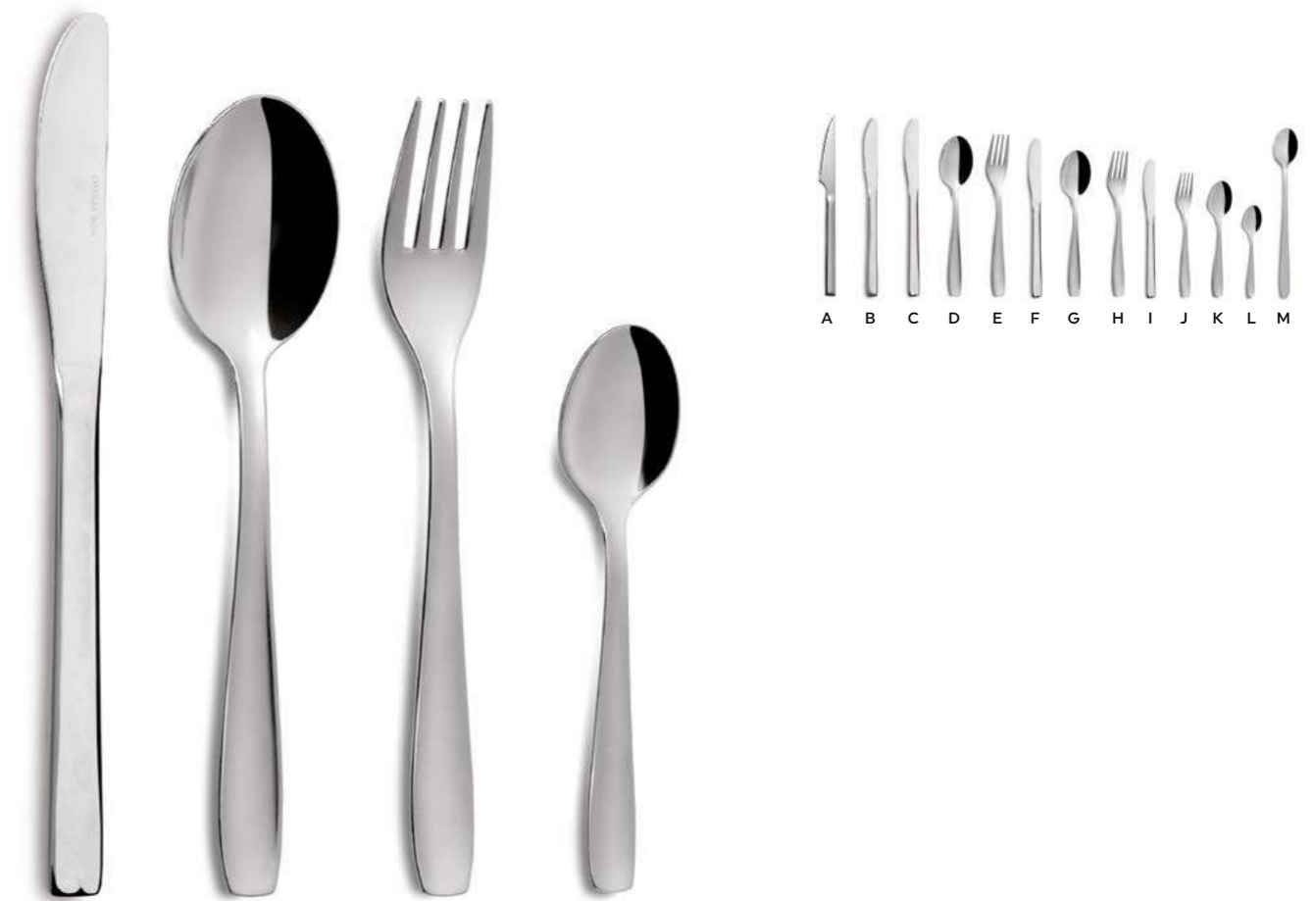

REF.	Descripción	€	UE/MOQ	▶ mm	✂ mm
A 2454	Cuchillo Chuletero Steak Knife, Couteau Steak, Coltello Bistecca, Steakmesser	1,81 €	12-120 / 12	225	
B 5497	Cuchillo Mesa Microdentado Table Knife Micro, Couteau Table Micro, Coltello Tavola Micro, Tafelmesser Micro	1,77 €	12-120 / 12	215	
C 0013	Cuchillo Mesa Table Knife, Couteau Table, Coltello Tavola, Tafelmesser	1,68 €	12-120 / 12	214	
D 0014	Cuchara Mesa Table Spoon, Cuillère Table, Cucchiaio Tavola, Tafellöffel	0,64 €	12-120 / 12	195	1,5
E 0015	Tenedor Mesa Table Fork, Fourchette Table, Forchetta Tavola, Tafelgabel	0,64 €	12-120 / 12	197	1,5
F 0018	Cuchillo Postre Dessert Knife, Couteau Dessert, Coltello Frutta, Dessertmesser	1,63 €	12-120 / 12	190	
G 0019	Cuchara Postre Dessert Spoon, Cuillère Dessert, Cucchiaio Frutta, Dessertlöffel	0,60 €	12-120 / 12	177	1,5
H 0020	Tenedor Postre Dessert Fork, Fourchette Dessert, Forchetta Frutta, Dessertgabel	0,60 €	12-120 / 12	178	1,5
I 0021	Cuchillo Lunch Cake Knife, Couteau Gâteau, Coltello Dolce, Kuchenmesser	1,46 €	12-120 / 12	165	
J 0022	Tenedor Lunch Cake Fork, Fourchette Gâteau, Forchetta Dolce, Kuchengabel	0,42 €	12-120 / 12	150	1,2
K 0023	Cuchara Café Tea Spoon, Cuillère Café, Cucchiaio Caffé, Kaffeelöffel	0,42 €	12-120 / 12	140	1,2
L 0024	Cuchara Moka Coffee/Moka Spoon, Cuillère Moka, Cucchiaio Moka, Mokkalöffel	0,37 €	12-120 / 12	110	1
M 0033	Cuchara Refresco Soda Spoon, Cuillère Mazagan, Cucchiaio Bibita, Longdrinklöffel	0,74 €	12-120 / 12	205	1,5

BROOKLYN

INOX Nickel Free 18% / 0,6mm / Vibrado



* Bolsa con apertura lateral.
Side-opening bag



* Bolsa con apertura lateral.
Side-opening bag



INOX
STAINLESS
STEEL
430

A B C D

REF.	Descripción	€	UE/MOQ	▶ mm	✂ mm
A 8334	Cuchillo Mesa table knife, couteau table, coltello tavola, tafelmesser	0,23 €	12-120 / 12	185	0,6
B 8335	Cuchara Mesa table spoon, cuillère table, cucchiaio tavola, tafellöffel	0,22 €	12-120 / 12	170	0,6
C 8336	Tenedor Mesa table fork, fourchette table, forchetta tavola, tafelgabel	0,19 €	12-120 / 12	170	0,6
D 8337	Cuchara Café tea spoon, cuillère café, cucchiaio caffè, kaffeelöffel	0,16 €	12-120 / 12	120	0,6
5254	Kit Cuchara Helado Y Servilleta set ice cream spoon + napkin set cuillère café + serviette set cucchiaio caffè + tovagliolo set kaffeelöffel + serviette	0,32 €	0-50 / 50		
8184	Kit 4 Pcs Cuchillo, Tenedor, Cuchara Café Y Servilleta set table knife/fork/tea spoon + napkin set couteau table/cuillère café/fourchette table + serviette set coltello tavola/cucchiaio caffè /forchetta tavola + tovagliolo set tafelmesser/kaffeelöffel/tafelgabel + serviette	1,03 €	0-120 / 120		

TAKE AWAY

PP
POLYPROPYLENE



* Los cubiertos no van incluidos
Cutlery is not included

REF.	Descripción	€	UE/MOQ	▶ mm	✂ mm
8373	CAJA POLIPROPILENO pp case, boîte pp, scatola pp, box pp	1,08 €	6	235	32

ECO

INOX Nickel Free 18% / 1,5mm / Vibrado

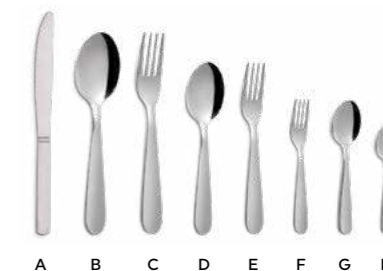

A B C D E F G H



REF.	Descripción	€	UE/MOQ	▶ mm	✂ mm
A 0481	Cuchillo Mesa Table Knife, Couteau Table, Coltello Tavola, Tafelmesser	0,73 €	12-240 / 240	220	2,5
B 3185	Cuchara Mesa Table Spoon, Cuillère Table, Cucchiaio Tavola, Tafellöffel	0,47 €	12-360 / 360	200	1,5
C 3186	Tenedor Mesa Table Fork, Fourchette Table, Forchetta Tavola, Tafelgabel	0,47 €	12-360 / 360	200	1,5
D 3187	Cuchara Postre Dessert Spoon, Cuillère Dessert, Cucchiaio Frutta, Dessertlöffel	0,44 €	12-360 / 360	170	1,5
H 3188	Tenedor Postre Dessert Fork, Fourchette Dessert, Forchetta Frutta, Dessertgabel	0,44 €	12-360 / 360	170	1,5
F 3189	Tenedor Lunch Cake Fork, Fourchette Gâteau, Forchetta Dolce, Kuchengabel	0,24 €	12-600 / 600	133	1,2
G 3190	Cuchara Café Tea Spoon, Cuillère Café, Cucchiaio Caffé, Kaffeelöffel	0,24 €	12-600 / 600	133	1,2
H 3191	Cuchara Moka Coffee/Moka Spoon, Cuillère Moka, Cucchiaio Moka, Mokkalöffel	0,20 €	12-600 / 600	110	1
4571	2 Cuchillo Mesa Eco 2 Table Knife Eco, 2 Couteau Table Eco, 2 Coltello Tavola Eco, 2 Tafelmesser Eco	1,31 €	18-270 / 270	220	
3192	3 Cuchara Mesa 3 Table Spoon, 3 Cuillère Table, 3 Cucchiaio Tavola, 3 Tafellöffel	1,31 €	12-180 / 180	170	1,5
3193	3 Tenedor Mesa 3 Table Fork, 3 Fourchette Table, 3 Forchetta Tavola, 3 Tafelgabel	1,31 €	12-180 / 180	170	1,5
3194	6 Tenedor Pastel 6 Cake Fork, 6 Fourchette Gâteau, 6 Forchetta Dolce, 6 Kuchengabel	1,31 €	12-180 / 180	133	1,2
3195	6 Cuchara Café 6 Tea Spoon, 6 Cuillère Café, 6 Cucchiaio Caffé, 6 Kaffeelöffel	1,31 €	12-180 / 180	133	1,2
3196	6 Cuchara Moka 6 Coffee/Moka Spoon, 6 Cuillère Moka, 6 Cucchiaio Moka, 6 Mokkalöffel	1,31 €	12-180 / 180	110	1

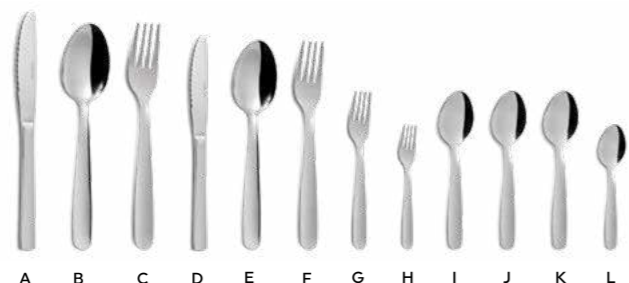

REF.	Descripción	€	UE/MOQ	▶ mm	✂ mm
A 1489	Cuchillo Mesa Table Knife, Couteau Table, Coltello Tavola, Tafelmesser	1,68 €	12-240 / 240	210	
B 0001	Cuchara Mesa Table Spoon, Cuillère Table, Cucchiaio Tavola, Tafellöffel	0,63 €	12-360 / 360	200	1,5
C 0002	Tenedor Mesa Table Fork, Fourchette Table, Forchetta Tavola, Tafelgabel	0,63 €	12-360 / 360	200	1,5
D 0009	Cuchillo Postre Dessert Knife, Couteau Dessert, Coltello Frutta, Dessertmesser	1,63 €	12-240 / 240	190	
E 0003	Cuchara Cadete Dessert Spoon, Cuillère Dessert, Cucchiaio Frutta, Dessertlöffel	0,58 €	12-360 / 360	185	1,2
F 0004	Tenedor Cadete Dessert Fork, Fourchette Dessert, Forchetta Frutta, Dessertgabel	0,58 €	12-360 / 360	185	1,2
G 0005	Tenedor Lunch Cake Fork, Fourchette Gâteau, Forchetta Dolce, Kuchengabel	0,31 €	12-600 / 600	140	1,2
H 4504	Tenedor Mini Lunch Mini Cake Fork, Fourchette Minigâteau, Forchetta Mini Dolce, Kuchengabel Klein	0,25 €	12-600 / 600	110	1
I 1664	Cuchara Café Reforzada Tea Spoon Reinf., Cuillère Café Reinformé, Cucchiaio Caffé Riformata, Kaffeelöffel Verstärkt	0,34 €	12-600 / 600	140	1,2
J 0006	Cuchara Café Tea Spoon, Cuillère Café, Cucchiaio Caffé, Kaffeelöffel	0,31 €	18-270 / 270	140	1
K 2731	Cuchara Café Eco Tea Spoon Eco, Cuillère Café Eco, Cucchiaio Caffé Eco, Kaffeelöffel Eco	0,26 €	12-180 / 180	140	0,9
L 0007	Cuchara Moka Coffee/Moka Spoon, Cuillère Moka, Cucchiaio Moka, Mokkalöffel	0,25 €	12-180 / 180	110	1
2459	2 Cuchara Mesa 2 Table Spoon, 2 Cuillère Table, 2 Cucchiaio Tavola, 2 Tafellöffel	1,18 €	18-270 / 270	185	1,2
2460	2 Tenedor Mesa 2 Table Fork, 2 Fourchette Table, 2 Forchetta Tavola, 2 Tafelgabel	1,18 €	18-270 / 270	185	1,2
2461	4 Tenedor Pastel 4 Cake Fork, 4 Fourchette Gâteau, 4 Forchetta Dolce, 4 Kuchengabel	1,18 €	18-270 / 270	140	1,2
2462	4 Cuchara Café 4 Tea Spoon, 4 Cuillère Café, 4 Cucchiaio Caffé, 4 Kaffeelöffel	1,18 €	18-270 / 270	140	1
2463	4 Cuchara Moka 4 Coffee/Moka Spoon, 4 Cuillère Moka, 4 Cucchiaio Moka, 4 Mokkalöffel	1,18 €	18-270 / 270	110	1

1003

INOX Nickel Free 18% / 1,2mm / Vibrado



REF.	Descripción	€	UE/MOQ	▶ mm	✂ mm
A 3618	Cuchillo Mesa Table Knife, Couteau Table, Coltello Tavola, Tafelmesser	1,69 €	120	224	
B 3548	3 Cuchara Mesa 3 Table Spoon, 3 Cuillère Table, 3 Cucchiaino Tavola, 3 Tafellöffel	1,31 €	180	185	1,2
C 3549	3 Tenedor Mesa 3 Table Fork, 3 Fourchette Table, 3 Forchetta Tavola, 3 Tafelgabel	1,31 €	180	185	1,2
D 3550	6 Tenedor Pastel 6 Cake Fork, 6 Fourchette Gâteau, 6 Forchetta Dolce, 6 Kuchengabel	1,31 €	180	140	1
E 3551	6 Cuchara Café 6 Tea Spoon, 6 Cuillère Café, 6 Cucciaio Caffé, 6 Kaffeelöffel	1,31 €	180	140	1
F 3552	6 Cuchara Moka 6 Coffee/Moka Spoon, 6 Cuillère Moka, 6 Cucciaio Moka, 6 Mokkalöffel	1,31 €	180	110	1

NERVIO

INOX Nickel Free 18% / 1,2mm / Vibrado

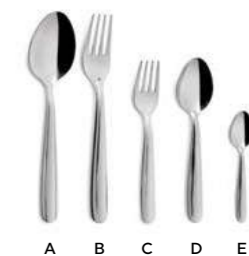

REF.	Descripción	€	UE/MOQ	▶ mm	✂ mm
A 0278	3 Cuchara Mesa 3 Table Spoon, 3 Cuillère Table, 3 Cucchiaino Tavola, 3 Tafellöffel	1,31 €	180	185	1,2
B 0279	3 Tenedor Mesa 3 Table Fork, 3 Fourchette Table, 3 Forchetta Tavola, 3 Tafelgabel	1,31 €	180	185	1,2
C 0280	6 Tenedor Pastel 6 Cake Fork, 6 Fourchette Gâteau, 6 Forchetta Dolce, 6 Kuchengabel	1,31 €	180	140	1,2
D 0281	6 Cuchara Café 6 Tea Spoon, 6 Cuillère Café, 6 Cucciaio Caffé, 6 Kaffeelöffel	1,31 €	180	140	1
E 0282	6 Cuchara Moka 6 Coffee/Moka Spoon, 6 Cuillère Moka, 6 Cucciaio Moka, 6 Mokkalöffel	1,31 €	180	110	1

ARABICA

INOX Nickel Free 18% / 1mm / Vibrado



INOX STAINLESS STEEL 430

REF.	Descripción	€	UE/MOQ	▶ mm	✂ mm
A 6338	Cuchara Café Tea spoon, 6 cuillère café, 6 cucciaio caffè, 6 kaffeelöffel	0,28 €	600	120	1
B 6339	Cuchara Moka Coffee/moka spoon, 6 cuillère moka, 6 cucciaio moka, 6 mokkalöffel	0,19 €	600	102	1



INOX STAINLESS STEEL 430

REF.	Descripción	€	UE/MOQ	▶ mm	✂ mm
A 5651	Corbata 6 Cuchara Aperitivo 6 aperitive spoon, 6 aperitive cuilliere, 6 aperitive spoon, 6 aperitive spoon	4,00 €	48	108	1,5



REPOSACUBIERTOS
CUTLERY HOLDERS



Soporte cubiertos Sakura
Sakura cutlery holder
Panier à couverts Sakura
Supporto coperte Sakura
Besteckhalter Sakura



REF.	W(mm)	H(mm)	€	UE / MOQ
7869	80	8,5	11,78	0-6-60 / 60



Reposacubiertos Atlántida
Atlantida cutlery holder
Panier à couverts Atlantida
Porta posate Atlantida
Besteckhalter Atlantida



REF.	W(mm)	H(mm)	€	UE / MOQ
10431	190	1,5	38,43	1-4-48 / 4



Reposacubiertos Icet
Ice cutlery holder
Repose à couverts ice
Supporto posate ice
Messerablage ice



REF.	W(mm)	H(mm)	€	UE / MOQ
11013	80	8,5	11,31	0-4-40 / 4



Reposapalillos bloque satin
Chopsticks holder satin
Porte baguette satin
Supporto posate satin
Besteckhalter satin



REF.	W(mm)	H(mm)	€	UE / MOQ
● 7554	60	8	3,89	0-12-120 / 12
● 7555	60	8	4,67	0-12-120 / 12

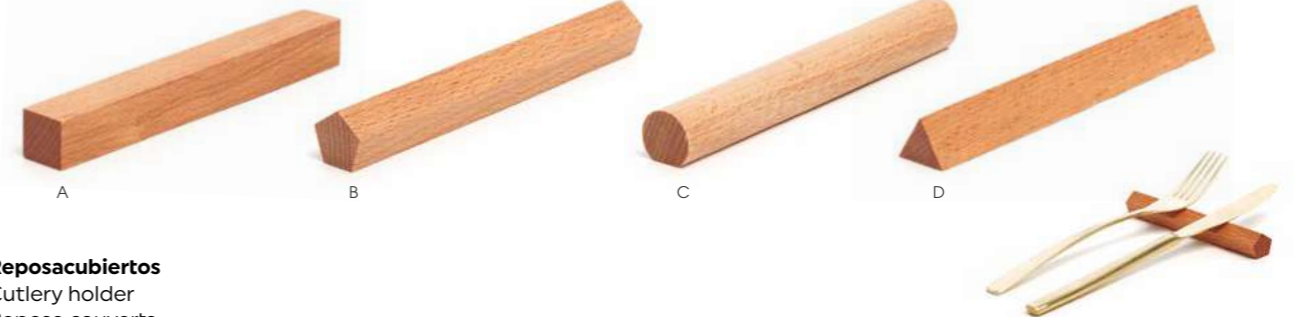

Reposacubiertos
Cutlery holder
Repose couverts
Supporto posate
Messerablage



	REF.	W(mm)	H(mm)	€	UE / MOQ
A	7843	122	8,5	1,63	1-60-240 / 6
B	7844	122	8,5	1,65	1-60-240 / 6
C	7841	122	8,5	1,65	1-60-240 / 6
D	7842	122	8,5	1,64	1-60-240 / 6

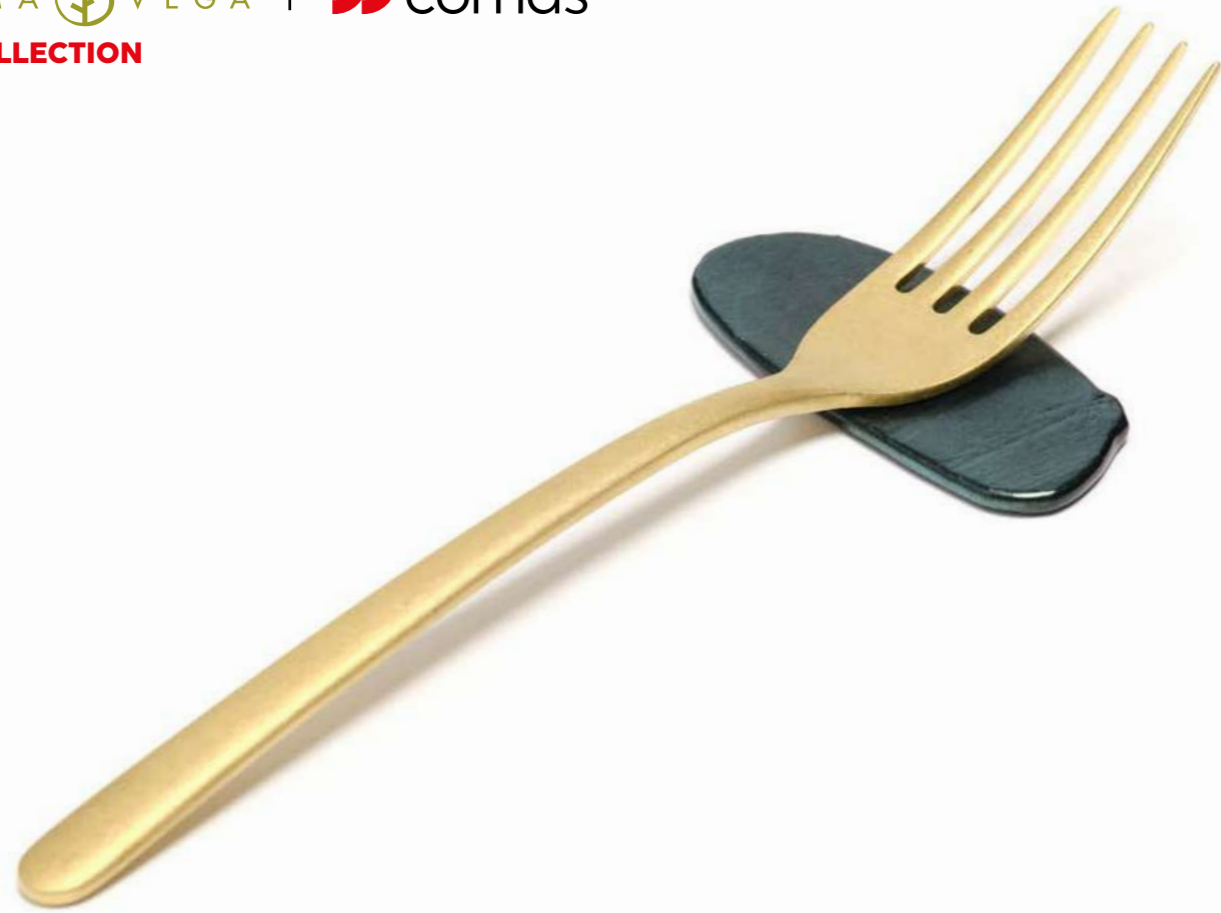

GLASS

Vidrio texturizado de manera manual. Cada pieza es única y exclusiva.

Hand-textured glass. Each piece is unique and exclusive.



Vidrio ligero y resistente. Diseño que facilitan la apilabilidad.

Lightweight and resistant glass and stackable design.

VELVET FINISH

Acabado superficial de partículas metálicas que le da un aspecto terciopelado.

Surface finish of metallic particles that gives it a velvety appearance.



REF.	Descripción	€	UE/MOQ	▶ mm	✂ mm
A 11957	Reposacubiertos Muna Velvet Oro muna velvet cutlery rest gold, repose-couverts muna velvet or, portaposate muna velvet oro, besteckhalter muna velvet gold	20,14 €	4	100	25
B 11958	Reposacubiertos Muna Velvet Verde muna velvet cutlery rest green, repose-couverts muna velvet vert, portaposate muna velvet verde, besteckhalter muna velvet grün	20,14 €	4	100	25
C 11962	Reposacubiertos Oval Velvet Oro oval velvet cutlery rest gold, repose-couverts oval velvet or, portaposate ovale velvet oro, ovaler besteckhalter velvet gold	16,69 €	4	70	30
D 11963	Reposacubiertos Oval Velvet Verde oval velvet cutlery rest green, repose-couverts oval velvet vert, portaposate ovale velvet verde, ovaler besteckhalter velvet grün	16,69 €	4	70	30

 GLASS

REPOSACUBIERTOS / CRISTAL
CUTLERY HOLDER/ GLASS



REF.	Descripción	€	UE/MOQ	▶ mm	✂ mm
A 11959	Cuchara Muna Velvet Oro muna velvet spoon gold, culliere muna velvet or, cucchiaio muna velvet oro, löffel muna velvet gold	16,16 €	4	100	30
B 11960	Cuchara Muna Velvet Verde muna velvet spoon green, repose-couverts muna velvet vert, portaposate muna velvet verde, besteckhalter muna velvet grün	16,16 €	4	100	30
C 11961	Cuchara Muna Blanco muna velvet spoon white, repose-couverts muna velvet or, portaposate muna velvet oro, besteckhalter muna velvet gold	15,86 €	4	100	30



REF.	Descripción	€	UE/MOQ	▶ mm	✂ mm
A 12008	Soporte Cuchara Muna Velvet Oro muna velvet cutlery rest gold, repose-couverts muna velvet or, portaposate muna velvet oro, besteckhalter muna velvet gold	53,40 €	2	110	250
B 12009	Soporte Cuchara Muna Velvet Verde muna velvet cutlery rest green, repose-couverts muna velvet vert, portaposate muna velvet verde, besteckhalter muna velvet grün	53,40 €	2	110	250
C 12010	Soporte Cuchara Muna Blanco muna velvet cutlery rest white, repose-couverts muna velvet or, portaposate muna velvet bianco, besteckhalter muna velvet gold	50,66 €	2	110	250
D 12011	Soporte Cuchara Muna Velvet Oro muna velvet cutlery rest gold, repose-couverts muna velvet or, portaposate muna velvet oro, besteckhalter muna velvet gold	47,93 €	2	150	150
E 12012	Soporte Cuchara Muna Velvet Verde muna velvet cutlery rest green, repose-couverts muna velvet or, portaposate muna velvet verde, besteckhalter muna velvet grün	47,93 €	2	150	150
F 12013	Soporte Cuchara Muna Blanco muna velvet cutlery rest white, repose-couverts muna velvet vert portaposate muna velvet verde, besteckhalter muna velvet grün	45,19 €	2	150	150

ACABADOS Y PVD

FINISHES AND PVD

Descubre la elegancia y resistencia de nuestra cubertería COMAS, fabricada en acero inoxidable de alta calidad y apta para todo tipo de alimentos.

Para quienes buscan un toque moderno y sofisticado, ofrecemos cubiertos con recubrimiento PVD, una tecnología avanzada que aporta un acabado espectacular y una protección extra contra arañazos, corrosión y desgaste.

● **Para mantener tus cubiertos impecables durante años, sigue estos consejos:**

- Limpia los restos de comida justo después de usarlos.
 - Evita el contacto prolongado con alimentos ácidos o muy salados.
 - Separa los cuchillos del resto para prevenir corrosión.
 - Usa detergentes de buena calidad y evita estropajos abrasivos.
 - Abre la puerta del lavavajillas al terminar el ciclo para evitar condensación.
- **Si usas cubiertos con recubrimiento PVD, además:**
- No uses programas de lavavajillas superiores a 40 °C.
 - Elige detergentes sin sales de sodio.
 - Seca los cubiertos de inmediato con un paño suave para evitar marcas.
 - Con estos cuidados, tu mesa lucirá siempre impecable y con estilo.

Discover the elegance and durability of our COMAS cutlery, made from high-quality stainless steel and safe for all types of food.

For those seeking a modern and sophisticated touch, we offer cutlery with PVD coating an advanced technology that provides a stunning finish and extra protection against scratches, corrosion, and everyday wear.

● **To keep your cutlery looking flawless for years, follow these care tips:**

- Clean food residues immediately after use.
 - Avoid prolonged contact with acidic or salty foods.
 - Store knives separately to prevent contact corrosion.
 - Use high-quality detergents and avoid abrasive scrubbers.
 - Open the dishwasher door after the cycle to prevent steam condensation.
- **If using PVD-coated cutlery, also:**
- Avoid dishwasher programs above 40 °C.
 - Choose detergents without sodium salts.
 - Dry immediately with a soft cloth to prevent surface marks.
 - With these care tips, your table will always look impeccable and stylish.



ACABADOS

FINISHES

Escoge el acabado que prefieras para cualquier colección del catálogo.
Choose the finish you prefer for any collection in the catalogue.



VINTAGE

Aspecto antiguo y desgastado que proporciona elegancia a la pieza. Efecto envejecido.

Ancient and worn aspect that gives elegance to the piece. Aged effect.



SATIN

Este tratamiento regala al cubierto un efecto satinado agradable al tacto.

This treatment gives the cover a satin effect pleasant to the touch.



MIRROR

El acabado más extremo, efecto espejo, sumará elegancia y sofisticación a la mesa.

The most extreme finish, mirror effect, will add elegance and sophistication to the table.



ICE POLVO DE LUNA

Efecto granulado "shot blasting". Acabado mate, suave y liso, que resalta la delicadeza de cada pieza.

"Shot blasting" effect. A matt and smooth finish that stand out the delicacy of every piece.



SILVER PLATE

Dale un toque de distinción a tus cubiertos añadiendo un acabado en plata.

Add a touch of distinction to your cutlery by adding a silver plated.



LASER MARK

Escoge la cubertería y customiza con tu logo cada una de las piezas.

Choose the cutlery and customize each piece with your logo.



TAMPO

Personaliza con los motivos que prefieras las piezas de tu cubertería.

Personalize with the motives that you prefer the pieces of your cutlery.



CHULETEROS

STEAK KIVES

- 192 KAJI
- 196 MEZZA
- 198 EVEREST
- 200 OLIU
- 202 SILEX
- 204 MAGNOLIA
- 206 UTSET + COMAS
- 212 HQ XL
- 214 HQ: 5Cr15Mov
- 216 HQ
- 222 INOX
- 223 NAPOLI PIZZA
- 224 ECO



Diseño moderno con alma de tradición japonesa.
Modern design with Japanese tradition soul.



Inspirado en los cuchillos japoneses Kiritsuke, Kaji es una pieza de diseño único. Su filo, hecho con acero VG-10, está recubierto por dos piezas de acero de Damasco, creadas mediante la unión y forja de 67 láminas de acero, generando de este modo un patrón único en cada cuchillo. KAJI revela el saber hacer artesanal con líneas ligeramente curvadas para un corte preciso.

El mango, de madera maciza con un toque de color, reinterpreta los mangos octogonales tradicionales para la mesa moderna, ofreciendo ergonomía y equilibrio perfectos.

Le acompaña un tenedor con dos puntas y mango simétrico, completando un conjunto icónico y exclusivo. El Nombre Kaji significa "forja" o "fuego" en japonés, refleja el proceso metódico de creación de esta pieza única.

Inspired by traditional Japanese Kiritsuke knives, Kaji is a uniquely designed piece. Its blade, crafted from VG-10 steel, is encased between two layers of Damascus steel, forged from 67 sheets to create a one-of-a-kind pattern on each knife. KAJI showcases expert craftsmanship with gently curved lines for precise cutting.

The handle, solid wood with a touch of colour, reinterprets traditional octagonal handles for the modern table, offering perfect ergonomics and balance.

It is accompanied by a fork with two prongs and a symmetrical handle, completing an iconic and exclusive set. The name Kaji means 'forge' or 'fire' in Japanese, reflecting the meticulous process of creating this unique piece.

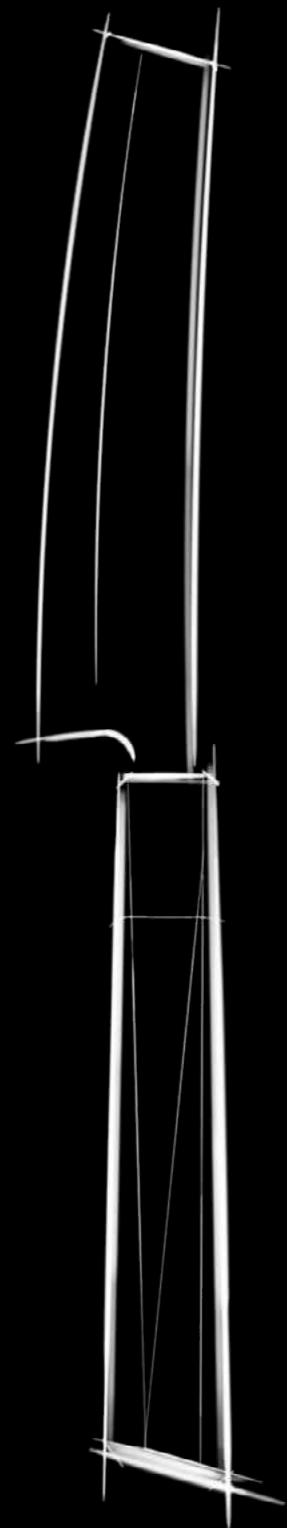



KAJI



Proyecto diseñado por:
Project designed by:

KAJI

INOX 18/10 / Mirror & Satin



Bahigüell



33 CAPAS ACERO 316L
33 LAYERS 316L STEEL

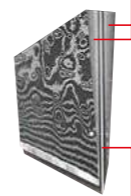

NÚCLEO ACERO VG10
VG10 STEEL CORE



A



B



C

INOX
STAINLESS
STEEL
304

INOX
STAINLESS
STEEL
304

SATIN

REF.	Descripción	€	UE/MOQ	▶ mm	✂ mm
A 10997	Cuchillo Chuletero Kaji Kaji Steak Knife, Couteau Steak Kaji, Coltello Bistecca Kaji, Steakmesser Kaji	64,06 €	1/6/30	232	
B 11942	Tenedor Chuletero Kaji Mirror Kaji Steak Fork, Fourchette Steak Kaji, Forchetta Bistecca Kaji, Steakgabel Kaji	6,69 €	0/6/60	210	6
C 12000	Tenedor Chuletero Kaji Satin Kaji Steak Fork, Fourchette Steak Kaji, Forchetta Bistecca Kaji, Steakgabel Kaji	6,69 €	0/6/60	210	6
D 12001	Estuche Con Cuchillo Y Tenedor Kaji Kaji Steak Knife And Fork Case, Étui À Couteau Steak Et Fourchette Kaji, Astuccio Per Coltello E Forchetta Kaji, Kaji Steakmesser Und Gabel Etui	84,56 €	1/6/36		



MEZZA



Proyecto diseñado por:
Project designed by:

Shu Hon Leung Andy

MEZZA

INOX 18/10 / Bimaterial



Recomendado lavar a mano
Hand washing recommended



MICARTA:

Material compuesto hecho a base de capas de tejidos, impregnadas con resina y prensadas. Curadas bajo alta presión y temperatura.

Composite material made of layers of fabrics, impregnated with resin and pressed. Cured under high pressure and temperature.



A B

FRONTAL INOX



REVERSO MICARTA

MEZZA es mucho más que un juego de mesa para carne. Fusiona tradición, diseño moderno y artesanía impecable. En la cultura gastronómica italiana, Mezza se utiliza a menudo para describir una pequeña porción de aperitivos o bebidas. Representa una experiencia gastronómica relajada y agradable, que permite disfrutar de deliciosa comida y pasar un buen rato con la familia y los amigos.

MEZZA is much more than a meat table set. Fusion of tradition, modern design and impeccable craftsmanship. In Italian dining culture, Mezza is often used to describe a small portion of appetizers or drinks. It represents a relaxed and enjoyable dining experience, allowing you to enjoy delicious food and have a good time with family and friends.



INOX
STAINLESS
STEEL
304

REF.	Descripción	€	UE/MOQ	▶ mm	✂ mm
A 12017	Cuchillo Chuletero Mezza Mezza Steak Knife, Couteau Steak Mezza , Coltello Bistecca Mezza , Steakmesser Mezza	12,30 €	0/6/60	237	4
B 12018	Tenedor Chuletero Mezza Mezza Steak Fork, Fourchette Steak Mezza , Forchetta Bistecca Mezza , Steakgabel Mezza	12,30 €	0/6/60	210	3,5
12019	Caja Presentación Con 2 Cuchillos Y 2 Tenedores Mezza Box With 2 Mezza Knives And 2 Forks, Boîte Avec 2 Couteaux Et 2 Fourchette Mezza, Scatola Con 2 Coltelli E 2 Forchette Mezza, Box Mit 2 Mezzamessen Und 2 Gaben	61,50 €	1/0/12		



Proyecto diseñado por:
Project designed by:

Pablo Castillo

EVEREST

INOX 18/10 / Mirror & Polvo de Luna

Everest surge como un conjunto bipieza de inspiración japonesa pero que a su vez combina en armonía con nuestra colección Atlántida para complementarla y ofrecer una opción más para los platos de carne.

Everest is a Japanese-inspired two-piece set that combines with harmony with our Atlántida collection to complement it and offer another option for meat dishes.



EVEREST

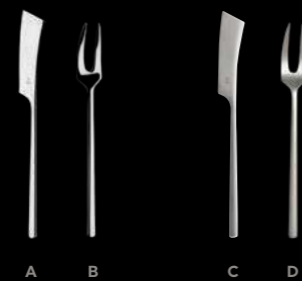

REF.	Descripción	€	UE/MOQ	▶ mm	✂ mm
A 11582	Cuchillo Chuletero Everest Mirror Steak Knife, Couteau Steak, Coltello Bistecca, Steakmesser	4,00 €	0/6/60	220	
B 11583	Tenedor Chuletero Everest Mirror Steak Fork, Fourchette Steak, Forchetta Bistecca, Steakgabel	3,45 €	0/6/60	206	
C 10988	Cuchillo Chuletero Everest P. De Luna Steak Knife, Couteau Steak, Forchetta Bistecca, Steakmesser	5,41 €	0/6/60	220	
D 10989	Tenedor Chuletero Everest P. De Luna Steak Fork, Fourchette Steak, Forchetta Bistecca, Steakgabel	4,82 €	0/6/60	206	



OLIU



Proyecto diseñado por:
Project designed by:

Silvia Rodriguez Petit
Liam Kelly Ortiz
Erik Obermüller Vilor
Albert Sadurní Roca



OLIU

INOX 18/10 / Mirror



Proyecto
OLIU.

ELISAVA Escuela Universitaria de Barcelona
Diseño e Ingeniería

Uno de los proyectos troncales que se desarrollaron en la 18a edición del Master en Diseño y Desarrollo de Producto, fue el proyecto que Comas propuso a los alumnos del Master. El reto consistió en diseñar y desarrollar un cuchillo icónico que pudiera complementar algunas de las colecciones actuales de nuestro catálogo.

Los 26 alumnos del Master, repartidos en 5 grupos, en la 1a fase conceptual presentaron 26 propuestas de diseño de nuevos cuchillos, de los cuales desarrollaron 12 propuestas con todo detalle y llegaron a un prototipo volumétrico de calidad, siguiendo las indicaciones de la empresa.

One of the core projects developed in the 18th edition of the Master's Degree in Product Design and Development was the project that Comas proposed to the Master's students. The challenge consisted of designing and developing an iconic knife that could complement some of the current collections in our catalogue.

The 26 Master's students, divided into 5 groups, presented 26 design proposals for new knives in the 1st conceptual phase, of which they developed 12 proposals in detail and reached a quality volumetric prototype, following the indications of the company.

REF.	Descripción	€	UE/MOQ	▶ mm	✂ mm
10994	Cuchillo Chuletero Oliu <small>Oliu Steak Knife, Couteau Steak Oliu, Coltello Bistecca Oliu, Oliu Steakmesser</small>	4,23 €	0/6/60	60	226



SILEX



A B

Proyecto diseñado por:
Project designed by:

Nil Carbó Raventós

SILEX

INOX 18/10 / Satin

Proyecto en colaboración con:



INOX
STAINLESS
STEEL
420



INOX
STAINLESS
STEEL
304



BAMBOO
WOOD

REF.	Descripción	€	UE/MOQ	▶ mm	✂ mm
A 6318	Cuchillo Chuletero Silex Silex Steak Knife, Couteau Steak Silex, Coltello Bistecca Silex, Steakmesser Silex	15,00 €	1/0/20	20	185
B 6319	Tenedor Chuletero Silex Silex Steak Fork, Fourchette Steak Silex, Forchetta Bistecca Silex, Steakgabel Silex	15,00 €	1/0/20	20	185
6322	Cuchillo + Tenedor Silex Silex Knife + Fork, Couteau + Fourchette Silex, Coltello + Forchetta Silex, Silex Messer + Gabel	30,00 €	1/0/8	8	





MAGNOLIA



A B

204

Proyecto diseñado por:
Project designed by:

Lúcid Design Agency



reddot design award
winner 2018

MAGNOLIA

INOX 18/10 / 9mm / PVD Negro / Mirror

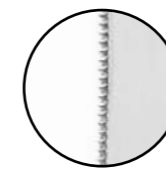

INOX
STAINLESS
STEEL
420



INOX
STAINLESS
STEEL
304



* Compatible con:
11988 / 11987

REF.	Descripción	€	UE/MOQ	▶ mm	✂ mm
A 6445	Cuchillo Chuletero K9 Magnolia Sierra K9 Magnolia Steak Knife, Couteau Steak K9 Magnolia Saw, Coltello Bistecca Segia K9 Magnolia Scie, Steakmesser K9 Magnolia Säge	9,34 €	0/6/60	226	
B 6446	Tenedor Chuletero K9 Magnolia K9 Magnolia Steak Fork, Fourchette Steak K9 Magnolia, Forchetta Bistecca K9 Magnolia, Steakgabel K9 Magnolia	9,34 €	0/6/60	203	9

205





HQ: 7Cr17Mov



Acero inoxidable 7Cr17Mov

7Cr17Mov Stainless steel

El acero de los cuchillos de mesa Utset ha sido tratado térmicamente para alcanzar una alta dureza y resistencia al desgaste y durabilidad, lo que significa que mantendrá su filo y estructura en condiciones de uso exigente.

El acero 7Cr17Mov es un tipo de acero que se ha hecho popular en la fabricación de cuchillos gracias a su resistencia a la corrosión.

The steel in Utset table knives has been heat-treated to achieve high hardness and wear resistance and durability, which means it will maintain its sharpness and structure under demanding conditions of use.

7Cr17Mov steel is a type of steel that has become popular in knife making due to its resistance to corrosion.

Madera estabilizada

Stabilised wood

Material fabricado mediante la inyección de resinas termoestables y color en la madera. Con esta inyección de resina se obtiene un sellado de mayor dureza, impermeabilidad y resistencia.

Además, con el color podemos personalizar la madera y crear diferentes patrones y variedad de gamas dándole un toque de sofisticación y originalidad al cuchillo.

Material manufactured by injecting thermosetting resins and color into the wood. With this injection, a seal of greater hardness, impermeability and resistance is obtained.

In addition, with colour we can personalise the wood and create different patterns and a variety of ranges, giving a touch of sophistication and originality to the knife.





ALTA DUREZA
HIGH HARDNESS
54 ±1 HRC



5Cr15Mov

EXTRA DURO
EXTRA HARD
57-59 HRC



7Cr17Mov



B



C



D



E



F



G



H



I



MIX
6 COLORES
6 COLOURS

REF.: 11993
PAG.: 203

REF.	Descripción	€	UE/MOQ	▶ mm	✂ mm
A 12005	Cuchillo Abreostas Con Funda Oyster Knife With Sleeve, Couteau À Huîtres Avec Étui, Apriostriche Con Fodero, Austermesser Mit Scheide	44,23 €	1/6/60	148	
B 11018	Cuchillo De Mesa Utset Olivo Olive Knife, Couteau A Olivier, Coltello Oliva, Olivenmesser	23,06 €	0/6/60	225	
C 11019	Cuchillo De Mesa Utset Ébano Ebony Knife, Couteau Ébène, Coltello Ebano, Ebenholz-Messer	23,06 €	0/6/60	225	
D 11067	Cuchillo De Mesa Madera Estabilizada Azul Blue Stabilized Wood Knife, Couteau En Bois Stabilisé Bleu, Coltello In Legno Stabilizzato Blue, Blaues Stabilisiertes Holzmesser	35,88 €	0/6/60	225	
E 11068	Cuchillo De Mesa Madera Estabilizada Verde Green Stabilized Wood Knife, Couteau En Bois Stabilisé Vert, Coltello In Legno Stabilizzato Verde, Grünes Stabilisiertes Holzmesser	35,88 €	0/6/60	225	
F 11069	Cuchillo De Mesa Madera Estabilizada Natural Natural Stabilized Wood Knife, Couteau En Bois Stabilisé Chau, Coltello In Legno Stabilizzato Calce, Kalk Stabilisiertes Holzmesser	35,88 €	0/6/60	225	
G 11070	Cuchillo De Mesa Madera Estabilizada Naranja Orange Stabilized Wood Knife, Couteau En Bois D'orange Stabilisé, Coltello In Legno Stabilizzato D'arancio, Orange Stabilisiertes Holzmesser	35,88 €	0/6/60	225	
H 11071	Cuchillo De Mesa Madera Estabilizada Negra Black Stabilized Wood Knife, Couteau En Bois Stabilisé Noir, Coltello In Legno Stabilizzato Nero, Schwarzes Stabilisiertes Holzmesser	35,88 €	0/6/60	225	
I 11072	Cuchillo De Mesa Madera Estabilizada Roja Red Stabilized Wood Knife, Couteau En Bois Stabilisé Rouge, Coltello In Legno Stabilizzato Rosso, Rot Stabilisiertes Holzmesser	35,88 €	0/6/60	225	



MIX
6 COLORES
6 COLOURS

REF.: 11993

Sistema de cierre con imán integrado en la madera.

Locking system with magnet integrated in the wood.

Madera de Acacia

Acacia wood



Se recomienda lavar a mano.
Hand washing is recommended



OPCIÓN DE PERSONALIZAR LA CAJA CON LASER.



OPTION TO CUSTOMISE THE BOX WITH LASERMARK.

1,54€ / PIEZA PIECE



REF.	Descripción	€	UE/MOQ	▶ mm	✂ mm
A 11993	Caja Estuche Madera 6 Chuleteros Mix Colores Wooden 6 Steak Knives Mix Coloured Case, 6 Couteau Steak Mix Couleurs Caisse En Bois, Scatola Di Legno 6 Coltello Bisteca Colorate Mix, 2 Steakmesser Holzkestewooden	200,16 €	1/6	260 x 130 x 40	
B 11988	Caja Estuche Madera Vacía 2 Chuleteros 2 Steak Knives Case, 2 Couteau Steak Caisse En Bois, Scatola Di Legno 2 Coltello Bisteca, 2 Steakmesser Holzkestewooden	14,35 €	1/2	260 x 80 x 35	
C 11987	Caja Estuche Madera Vacía 6 Chuleteros Wooden 6 Steak Knives Case, 6 Couteau Steak Caisse En Bois, Scatola Di Legno 6 Coltello Bisteca, 2 Steakmesser Holzkestewooden	17,94 €	1/6	260 x 130 x 40	

NEW



Chuleteros / Steak Knives

HQ XL

REF.	Descripción	€	UE/MOQ	▶ mm	✂ mm
A 12181	Expositor para 6 cuchillos chuleteros Stand for 6 steak knives, Présentoir pour 6 couteaux à steak, Espositore per 6 coltelli da bistecca, Halter für 6 Steakmesser	14,71€	0/6/60	280 x 350 x 20	



REF.	Descripción	€	UE/MOQ	▶ mm	✂ mm
A 7445	Cuchillo Chuleton Aconcagua Black Aconcagua Black Steak Knife, Couteau Steak Aconcagua Black, Coltello Bistecca Aconcagua Black, Steak Messer Aconcagua Black	14,63 €	0/6/60	177	
B 7446	Cuchillo Chuleton Aconcagua Aconcagua Steak Knife, Couteau Steak Aconcagua, Coltello Bistecca Aconcagua, Steak Messer Aconcagua	14,63 €	0/6/60	165	
C 3100	Cuchillo Chuletero Churrasco Churrasco Steak Knife, Couteau Steak Churrasco, Couteau Steak Churrasco, Coltello Bistecca Churrasco, Steakmesser Churrasco	6,40 €	0/6/60	254	



REF.	Descripción	€	UE/MOQ	▶ mm	✂ mm
A 12016	Cuchillo Chuletero Kamet Wengé Kamet Wengé Steak Knife, Couteau Steak Kamet Wengé, Coltello Bistecca Kamet Wengé, Steak Messer Kamet Wengé	5,64 €	60	235	
NEW A 12049	Blister 3 Cuchillos Chuleteros Kamet Wengé Kamet Wengé Steak Knife, Couteau Steak Kamet Wengé, Coltello Bistecca Kamet Wengé, Steak Messer Kamet Wengé	17,38 €	60	235	
B 12015	Cuchillo Chuletero Kamet Rosewood Kamet Rosewood Steak Knife, Couteau Steak Kamet Rosewood, Coltello Bistecca Kamet Rosewood, Steak Messer Kamet Rosewood	5,64 €	60	235	
NEW B 12050	Blister 3 Cuchillos Chuleteros Kamet Rosewood Kamet Rosewood Steak Knife, Couteau Steak Kamet Rosewood, Coltello Bistecca Kamet Rosewood, Steak Messer Kamet Rosewood	17,38 €	60	235	
C 12031	Cuchillo Chuletero Lhotse Pakka Black Lhotse Pakka Steak Knife, Couteau Steak Lhotse Pakka, Coltello Bistecca Lhotse Pakka, Steak Messer Lhotse Pakka	7,69 €	60	248	
D 12032	Cuchillo Chuletero Lhotse Pakka Red Lhotse Pakka Steak Knife, Couteau Steak Lhotse Pakka, Coltello Bistecca Lhotse Pakka, Steak Messer Lhotse Pakka	7,69 €		248	
E 12033	Cuchillo Chuletero Lhotse Pakka Verde Lhotse Pakka Steak Knife, Couteau Steak Lhotse Pakka, Coltello Bistecca Lhotse Pakka, Steak Messer Lhotse Pakka	7,69 €		248	



5CR15Mov

Acero de gran dureza
High hardness steel

¿Eres un amante de la carne? Si es así, deberías utilizar cuchillos con un acero de gran calidad y un buen afilado para que el corte de la carne sea fácil y limpio. Y es que con un buen cuchillo se puede disfrutar al máximo de un delicioso trozo de carne.

Are you a meat lover? If so, you should use knives with high quality steel and a good sharpening to make cutting meat easy and clean. With a good knife, you can enjoy a delicious piece of meat to the full.

ACERO DE GRAN DUREZA
HIGH HARDNESS STEEL



CUCHILLO CHULETERO ANETO MIKARTA



* Caja 6 chuleteros.



* Compatible con: 11988 /11987

REF.	Descripción	€	UE/MOQ	▶ mm	✂ mm
A 8508	Cuchillo Chuletero Aneto Mikarta Aneto Mikarta Steak Knife, Couteau Steak Aneto Mikarta, Coltello Bistecca Aneto Mikarta, Steakmesser Aneto Mikarta	12,01 €	0/6/60	223	
B 7532	Cuchillo Chuletero Aneto Aneto Steak Knife, Couteau Steak Aneto, Coltello Bistecca Aneto, Steakmesser Aneto	7,90 €	0/6/60	223	
C 3013	Chuletero Alps Filo Alps Filo Steak Knife, Couteau Steak Alps Filo, Coltello Bistecca Alps Filo, Steakmesser Alps Filo	9,44 €	0/6/60	230	
* 6887	6 Pcs Madera Alps Filo Alps Filo Steak Knife 6 Pieces Wood, Écrin Bois 6 Couteaux Alps Filo, 6 Pz Legno Alps Filo, 6- Teilige Holz-Untersetzer Alps Filo	66,39 €	1/6/78	230	
D 7068	Cuchillo Chuletero Montblanc Montblanc Steak Knife, Couteau Steak Montblanc, Coltello Bistecca Montblanc, Steakmesser Montblanc	9,57 €	0/6/60	230	
* 5285	6 Pcs Madera Montblanc Montblanc Steak Knife 6 Pieces Wood, Écrin Bois 6 Couteaux Montblanc, 6 Pz Legno Montblanc, 6- Teilige Holz-Untersetzer Montblanc	70,08 €	1/6/78/	230	
E 8595	Cuchillo Chuletero Montblanc Negro Montblanc Black Steak Knife, Couteau Steak Montblanc Black, Coltello Bistecca Montblanc Black, Steak Messer Montblanc Black	10,84 €	0/6/60	230	
F 10972	Cuchillo Abrestras Oyster Knife, Couteau A Huitres, Aprostriche, Austernmesser	8,16 €	0/6/60	160	



Chuleteros / Steak Knives

HQ: 5Cr15Mov

El acero 5CR15Mov tiene una baja porción de carbono lo que lo hace un material de gran dureza, por lo que el filo conserva más tiempo la capacidad de corte.

Además, ofrece una gran resistencia a la corrosión con más del 15% de cromo.

5CR15Mov steel has a low carbon content which makes it a very hard material, so the cutting edge retains its cutting ability for a longer period of time.

In addition, it offers high corrosion resistance with more than 15% chromium.

ALTA DUREZA
HIGH HARDNESS  5Cr15Mov





CUCHILLO CHULETERO ALPS



* Caja 6 chuleteros.



* Compatible con: 11988 /11987

REF.	Descripción	€	UE/MOQ	▶ mm	✂ mm
A 10971	Cuchillo Chuletero Denali Denali Steak Knife, Couteau Steak Denali, Coltello Bistecca Denali, Denali Steakmesser	9,45 €	60	225	
B 3000	Chuletero Alps Alps Steak Knife, Couteau Steak Alps, Coltello Bistecca Alps, Steakmesser Alps	9,45 €	60	230	
* 5286	6 Pcs Madera Alps Alps Steak Knife 6 Pieces Wood, Écrin 6 Pièces Fourchette Alps, 6 Pz Legno Alps, 6- Teilige Holz-Untersetzer Alps	67,20 €	6	230	
C 6162	Tenedor Chuletero Alps Alps Steak Fork, Fourchette Steak Alps, Forchetta Bistecca Alps, Steakgabel Alps	9,45 €	60	227	
* 6334	6 Pcs Madera Tenedor Alps Alps Fork 6 Pieces Wood, Écrin 6 Pièces Fourchette Alps, Bauletto In Legno 6 Pz. Forchetta Alps, Gabel 6 Stück Holz Alps	67,20 €	6	227	
D 10973	Cuchillo Chuletero Mini Alps Alps Mini Steak Knife, Couteau Steak Alps Mini, Coltello Bistecca Alps Mini, Steakmesser Alps Mini	6,40 €	60	190	
E 10974	Tenedor Chuletero Mini Alps Alps Mini Steak Fork, Fourchette Steak Alps Mini, Forchetta Bistecca Alps Mini, Steakgabel Alps Mini	6,40 €	60	175	
F 3001	Chuletero Nicolas Nicolas Steak Knife, Couteau Steak Nicolas, Coltello Bistecca Nicolas, Steakmesser Nicolas	8,48 €	60	230	
* 5280	6 Pcs Madera Nicolas Nicolas 6 Pieces Wood, Écrin 6 Pièces Nicolas, Bauletto In Legno 6 Pz. Nicolas,	61,78 €	6	230	
G 3137	Chuletero K2 Negro K2 Black Steak Knife, Couteau Steak K2 Noir, Coltello Bistecca K2 Nero, Steakmesser K2 Schwarz	10,85 €	60	225	
* 5278	6 Pcs Madera K2 Negro K2 Black 6 Pieces Wood, Écrin 6 Pièces K2 Noir, Bauletto In Legno 6 Pz. K2 Nero, K2 Schwarz 6 Stück Holz	70,32 €	6	225	
H 3136	Chuletero K2 K2 Steak Knife, Couteau Steak K2, Coltello Bistecca K2, Steakmesser K2	10,79 €	60	225	
* 5287	6 Pcs Madera K2 K2 6 Pieces Wood, Écrin 6 Pièces K2, Bauletto In Legno 6 Pz. K2, K2 6 Stück Holz	71,29 €	6	225	





REF.	Descripción	€	UE/MOQ	▶ mm	✂ mm
A 7442	Cuchillo Chuletero Acr White Acr White Steak Knife, Couteau Steak Acr White, Coltello Bistecca Acr White, Steak Messer Acr White	9,09 €	60	225	
B 7443	Cuchillo Chuletero Acr Red Acr Red Steak Knife, Couteau Steak Acr Red, Coltello Bistecca Acr Red, Steak Messer Acr Red	9,09 €	60	225	
C 3010	Cuchillo Chuletero Acr Black Steak Knife Rambo, Couteau Steak Rambo, Coltello Bistecca Rambo, Steakmesser Rambo	9,09 €	60	225	
5279	6 Pcs Madera Acr Black Rambo 6 Pieces Wood, Écrin 6 Pièces Rambo, Bauletto In Legno 6 Pz. Rambo, Rambo 6 Stück Holz	62,60 €	6	225	
D 3011	Tenedor Chuletero Acr Negro Zermatt Steak Knife, Couteau Steak Zermatt, Coltello Bistecca Zermatt, Steakmesser Zermatt	9,09 €	60	210	
6335	6 Pcs Madera Tenedor Acr Black Kilimanjaro Steak Knife, Couteau Steak Kilimanjaro, Coltello Bistecca Kilimanjaro, Steakmesser Kilimanjaro	62,60 €	6	210	
E 7447	Cuchillo Queso Zermatt Zermatt Cheese Knife, Couteau A Fromage Zermatt, Coltello Da Formaggio Zermatt, Kassemesser Zermatt	10,87 €	60	123	
F 6163	Cuchillo Chuletero Zermatt Zermatt Steak Knife, Couteau Steak Zermatt, Coltello Bistecca Zermatt, Steakmesser Zermatt	10,60 €	60	227	



REF.	Descripción	€	UE/MOQ	▶ mm	✂ mm
A 12192	Cuchillo Chuletero Royal Royal Steak Knife, Couteau Steak Royal, Coltello Bistecca Royal, Steak Messer Royal	7,50 €	60	245	13
B 12191	Tenedor Chuletero Royal Royal Steak Knife, Couteau Steak Royal, Coltello Bistecca Royal, Steak Messer Royal	7,50 €	6	220	13



CUCHILLO CHULETERO K6 - BOJ SATIN GOLD



* Caja 6 chuleteros.



REF.	Descripción	€	UE/MOQ	▶ mm	✂ mm
A 12006	Cuchillo Chuletero Europa Europa Steak Knife, Couteau Steakeuropa, Coltello Bistecca Europa, Steakmesser Europa	2,05 €	120	215	
B 11584	Cuchillo Chuletero Santorini Santorini Steak Knife, Couteau Steak Santorini, Coltello Bistecca Santorini, Steakmesser Santorini	3,18 €	120	235	
C 6161	Cuchillo Chuletero Geometric Geometric Steak Knife, Couteau Steak Geometric, Coltello Bistecca Geometric, Steakmesser Geometric	5,11 €	60	232	
* 6333	6 Pcs Madera Geometric Geometric 6 Pieces Wood, Écrin 6 Pièces Geometric, Bauletto In Legno 6 Pz. Geometric, Geometric 6 Stück Holz	39,37 €	6	232	
D 3107	Cuchillo Chuletero Sutil Sutil Steak Knife, Couteau Steak Sutil, Coltello Bistecca Sutil, Sutil Steakmesser	3,72 €	60	232	
* 5277	6 Pcs Madera Sutil Sutil 6 Pieces Wood, Écrin 6 Pièces Sutil, Bauletto In Legno 6 Pz. Sutil, Sutil 6 Stück Holz	31,21 €	6	232	
E 2818	Cuchillo Chuletero Rambo Rambo Steak Knife, Couteau Steak Rambo, Coltello Bistecca Rambo, Rambo Steakmesser	6,07 €	60	225	
* 5288	6 Pcs Madera Rambo Rambo 6 Pieces Wood, Écrin 6 Pièces Rambo, Bauletto In Legno 6 Pz. Rambo, Rambo 6 Stück Holz	44,44 €	6	225	
F 2999	Cuchillo Chuletero K6 Boj Satin K6 Boj Satin Steak Knife, Couteau Steak K6 Satin Boj, Coltello Bistecca K6 Boj Satin, Steakmesser K6 Boj Satin	5,07 €	60	221	
G 6013	Cuchillo Chuletero K6.2 Boj Mirror K6.2 Boj Steak Knife, Couteau Steak K6.2 Boj, Coltello Bistecca K6.2 Boj Satin, Steakmesser K6.2 Boj	5,07 €	60	221	
H 7432	Cuchillo Chuletero K6 Boj Satin Gold Boj Satin/K6 Steak Knife Gold, Couteau Steak Boj Satin/K6 Gold, Coltello Bistecca Boj Satin/K6 Gold, Steakmesser Boj Satin/K6 Gold	9,34 €	60	221	
I 7433	Cuchillo Chuletero K6 Boj Satin Gunmetal Boj Satin/K6 Steak Knife Gunmetal, Couteau Steak Boj Satin/K6 Gunmetal, Coltello Bistecca Boj Satin/K6 Gunmetal, Steakmesser Boj Satin/K6 Gunmetal	9,34 €	60	221	
J 7431	Cuchillo Chuletero K6 Boj Satin Copper Boj Satin/K6 Steak Knife Copper, Couteau Steak Boj Satin/K6 Copper, Coltello Bistecca Boj Satin/K6 Copper, Steakmesser Boj Satin/K6 Copper	9,34 €	60	221	





AISI 430

REF.	Descripción	€	UE/MOQ	▶ mm	✂ mm
12038	Cuchillo Pizza Nordic Eco Pizza Knife Nordic Eco, Couteau À Pizza Nordic Eco, Coltello Per Pizza Nordic Eco, Pizzamesser Nordic Eco	1,50 €			
A 2072	Cuchillo Chuletero Perfect Perfect Steak Knife, Couteau Steak Perfect, Coltello Bistecca Perfect, Perfekt Steakmesser	2,34 €	0/12/120	224	
B 5903	Tenedor Chuletero Perfect Perfect Steak Fork, Fourchette Steak Perfect, Forchetta Bistecca Perfect, Perfekt Steakgabel	2,01 €	0/12/120	195	
C 2732	Cuchillo Chuletero Perfect Premium Perfect Premium Steak Knife, Couteau Steak Perfect Premium, Coltello Bistecca Perfect Premium, Perfekt Premium Steakmesser	2,76 €	0/12/120	224	
D 5447	Cuchillo Chuletero Perfect Eco 2 Perfect Steak Knife Lacasa, 2 Couteau Steak Perfect Lacasa, 2 Coltello Bistecca Perfect Lacasa, 2 Perfekt Steakmesser Lacasa	1,98 €	2/0/48	215	
E M1538	2 Cuchillo Chuletero Perfect Eco Nordic Steak Knife, Couteau Steak Nordic, Coltello Bistecca Nordic, Nordic Steakmesser	4,25 €	0/12/120	230	
F 5631	Cuchillo Chuletero Nordic Nordic Steak Knife, Couteau Steak Nordic, Coltello Bistecca Nordic, Nordic Steakmesser	2,48 €	0/12/120	224	
G 4713	Cuchillo Chuletero Nordic Eco Nordic Steak Knife Eco, Couteau Steak Nordic Eco, Coltello Bistecca Nordic Eco, Nordic Steakmesser Eco	1,71 €	0/12/120	230	
H 1339	Cuchillo Chuletero Madrid Steak Knife, Couteau Steak Madrid, Coltello Bistecca Madrid, Steakmesser Madrid	2,82€	0/12/120	230	

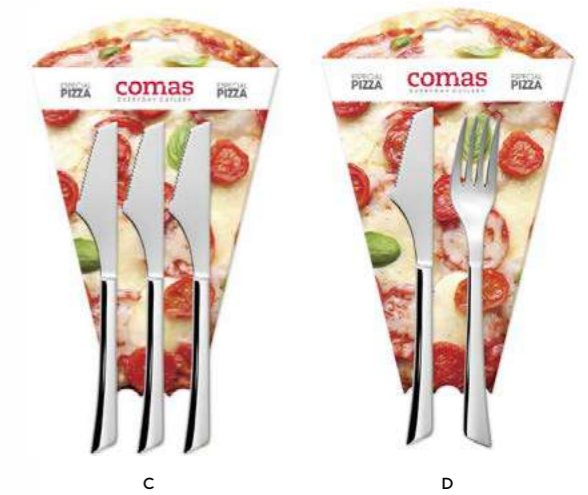

REF.	Descripción	€	UE/MOQ	▶ mm	✂ mm
A 3263	Cuchillo Pizza Pizza Knife, Couteau Pizza, Coltello Pizza, Pizza Tafelmesser	2,76 €	12-120 / 120	205	
B 3264	Tenedor Pizza Pizza Fork, Fourchette Pizza, Forchetta Pizza, Pizza Gabel	2,11 €	12-120 / 120	202	
C 3265	Blister 3 Cuchillo Pizza Blister 3 Pizza Knife, Blister 3 Couteau Pizza, Blister 3 Coltello Pizza, Blister Pizza-Messer	9,21 €	0-24 / 24	205	
D 3266	Blister Cuchillo + Tenedor Pizza Blister Pizza Knife + Fork, Blister Couteau + Fourchette Pizza, Blister Coltello + Forchetta Pizza, Blister Pizza Messer + Gabel	5,42 €	0-24 / 24	205	



REF.	Descripción	€	UE/MOQ	▶ mm	✂ mm
A 7535	Cuchillo Chuletero Rojo Puntilla Steak Knife Red Couteau Steak Red Coltello Bistecca Rosso Steakmesser Rot	3,18 €	24	230	
B 8301	Blister Chuletero Rojo Puntilla Steak Knife Red 2 Blister Blister 2 Couteau Steak Red Blister 2 Coltello Bistecca Rosso Blister 2 Steakmesser Red	7,19 €	24	230	
C 11585	Cuchillo Chuletero Negro Puntilla Steak Knife, Couteau Steak, Coltello Bistecca, Steakmesser	3,18 €	24	230	
NEW D 12039	Cuchillo Chuletero Punta Redonda Steak Knife, Couteau Steak, Coltello Bistecca, Steakmesser	2,82 €	24	230	
E 10990	Blister 6 Chuletero Fino Sierra Blister 6 Slim Serrated Steak Knife Blister 6 Couteaux Steak Avec Lame Dentelée Blister 6 Coltelli Bistecca Lama Dentata Blister De 6 Couteaux À Steak Avec Lame Dentelée	13,45 €	24	215	
F 10991	Blister 6 Chuletero Fino Liso Blister 6 Fine Smooth Steak Knife Blister 6 Couteaux Steak Avec Lame Lisse Blister 6 Coltelli Bistecca Lama Liscia Blister 6 Fine Smooth Steak Knife	13,45 €	24	215	
G 10992	Blister 6 Cuchillo Mesa Eco Blister 6 Eco Table Knife Blister De 6 Couteaux Table Eco Blister 6 Coltelli Tavola Eco Blister 6 Eco Table Knife	8,34 €	24	215	
H 10993	Blister 2 Chuletero Forjado Blister 2 Forged Steak Knife Blister 2 Couteaux Steak Forgés Blister 2 Coltelli Bistecca Forgiati Blister 2 Forged Steak Knife	11,41 €	24	225	

REF.	Descripción	€	UE/MOQ	▶ mm	✂ mm
A 3002	Chuleton Negro Big Black Steak Knife, Gros Couteau Steak Noir, Grande Coltello Bistecca Nero, Gros Steakmesser Schwarz	3,37 €	120	232	
B 3004	Chuletero Fino Negro Black Thin Steak Knife, Couteau Steak Fin Noir, Coltello Bistecca Sottile Nero, Steakmesser Schwarz Dünn	3,02 €	120	212	
C 3003	Tenedor Chuletero Negro Black Steak Fork, Fourchette Steak Noire, Forchetta Bistecca Nera, Steakgabel Schwarz	3,37 €	120	191	
D 0072	Cuchillo Manteca Marfil Ivory Knife, Couteau Ivoire, Coltello Avorio, Elfenbeinmesser	0,68 €	288	200	
E 3006	Chuletero Eco Eco Steak Knife, Couteau Steak Eco, Coltello Bistecca Eco, Steakmesser Eco	0,80 €	144	220	



VAJILLA

VAJILLA COMAS COMAS TABLEWARE

- 230 DOLMEN
- 232 LIMITS
- 234 TERRA
- 238 LAGUNA
- 240 TORNO
- 242 PLAISIR
- 248 AMBAR
- 252 MINI KODAI
- 254 DIM SUM

PIOLI x COMAS

- 258 ONARA
- 260 MOCHA
- 261 GLEAM
- 262 SIENA
- 263 ARVIA
- 264 ORIENTAL
- 265 NEPTUNE
- 266 ZENIR
- 267 SAKURA
- 268 OLIVA
- 270 MILENA
- 271 MARINA
- 272 POLANO
- 273 HARMONIA
- 275 ALBA



Vajillas

Tableware



Comas y la vajilla

Trabajando junto a maestros artesanos, artistas, diseñadores y reconocidos productores para ofrecer una mayor variedad e innovación en vajilla.

Diseño, innovación, calidad, funcionalidad, y accesibilidad. Nuestro cinco valores ahora también en nuestra ampliación de la oferta de vajillas de la mano de Jordi Travería y Luesma & Vega.

Este año también, consolidando nuestro partnership con Pioli para poder ofrecer desde Comas una mayor diversidad de soluciones en porcelana y stoneware.

Comas and tableware

Working alongside master craftsmen, artists, designers and renowned producers to offer you greater variety and innovation in tableware.

Design, innovation, quality, functionality, and accessibility. Our five values, now also in our expanded tableware offer by Jordi Travería and Luesma & Vega.



NEW



STONEWARE

DOLMEN

Plato base reversible
 Reversible base plate
 Assiette de base réversible
 Piatto base reversibile
 Wendbare Basisplatte

REF.	Ø(cm)	H(cm)	€	MOQ
12288	31	1,5	39,87	4



Peana / bol
 Base / bowl
 Base / bol
 Base / ciotola
 Sockel / schale

REF.	Ø(cm)	H(cm)	ml	€	MOQ
12289	13	5	380	12,82	6
12290	15,5	5	600	18,60	6



Peana redonda
 Round base
 Base ronde
 Base rotonda
 Runder sockel

REF.	Ø(cm)	H(cm)	ml	€	MOQ
12293	11,5	5	100	9,91	4
12294	13	7	170	13,01	4



Peana diábolo
 Diabolo base
 Base diabolo
 Base diabolo
 Diabolo-sockel

REF.	Ø(cm)	H(cm)	€	MOQ
12291	9,5	7	12,63	4
12292	11,5	8	15,73	4



NEW



STONEWARE

LIMITS



Plato llano coupé
Coupe flat plate
Assiette plate coupe
Piatto piano coupe
Coupe-flacher teller

REF.	Ø(cm)	H(cm)	€	MOQ
12276	24	2,8	22,43	6



Plato llano
Flat plate
Assiette plate
Piatto piano
Flacher teller

REF.	Ø(cm)	H(cm)	€	MOQ
12275	24	1,2	22,26	6



Peana redonda
Round base
Base ronde
Base rotonda
Runder sockel

REF.	Ø(cm)	H(cm)	ml	€	MOQ
12273	11,5	5	100	9,91	4
12274	13	7	170	13,01	4



STONEWARE



Plato 2 en 1 reversible
 Reversible 2-in-1 plate
 Plateau 2 en 1 réversible
 Piatto 2 in 1 reversibile
 2-In-1-wendbarer teller

REF.	Ø _(cm)	H _(cm)	ml	€	MOQ
12277	16	4,5	400	14,17	4
12278	21	4,5	700	26,14	4
12279	24	4,5	950	30,88	2



Fuente
 Main course
 Plat de service
 Piatto da portata
 Servierplatte

REF.	Ø _(cm)	H _(cm)	ml	€	MOQ
12280	25	5,5	1400	29,96	2
12281	28	5	1800	35,35	2

Reversible: Un lado funciona como plato llano ideal para presentaciones planas; el reverso como bol para platos con salsas, cremas o elementos líquidos.

Reversible: One side functions as a flat plate, ideal for simple presentations; the reverse serves as a bowl for dishes with sauces, creams, or liquid elements.

TERRA



PROFUNDIDAD
1,6 cm



PROFUNDIDAD
2,8 cm



Bol
 Bowl
 Bol
 Ciotola
 Schale

REF.	Ø _(cm)	H _(cm)	ml	€	MOQ
12285	11,5	5	250	7,00	6
12286	15	6	450	11,21	6
12287	20,5	7	1200	19,01	4

Plato llano
 Flat plate
 Assiette plate
 Piatto piano
 Flacher teller

REF.	Ø _(cm)	H _(cm)	€	MOQ
12282	21	1,5	9,77	6
12283	23,5	1,5	12,73	6
12284	27	1,5	16,47	4



Plato esfera
Spherical plate
Assiette sphérique
Piatto sferico
Kugelförmiger Teller

REF.	COLOR	SIZE	Ø _(cm)	H _(cm)	cc	€	UE / MOQ
12416	●	S	6,5	6,5	30	5,59	1-4-72 / 6
12417	●	L	13	13	400	15,67	1-4-72 / 4
12418	●	S	6,5	6,5	30	5,59	1-4-72 / 6
12419	●	L	13	13	400	15,67	1-4-72 / 4
12420	●	S	6,5	6,5	30	5,59	1-4-72 / 6
12421	●	L	13	13	400	15,67	1-4-72 / 4

Plato rocks Dolmen
Rocks plate
Assiete roches
Piatto rocce
Felsenteller

REF.	Ø _(cm)	H _(cm)	€	MOQ
12422	21	1,8	14,58	6

Teja wave Limits
Wave tile
Assiete Tuile ondulé
Tegola ondulata
Bernstein

REF.	L _(cm)	W _(cm)	H _(cm)	€	MOQ
12423	27	6	1,8	10,05	6



Plato llano coupé
Coupe flat plate
Assiette plate coupe
Piatto piano coupe
Coupe-flacher teller

REF.	Ø _(cm)	H _(cm)	€	MOQ
12237	22	2,8	7,88	6
12236	28	3,3	9,65	6

Plato hondo
Deep plate
Assiette creuse
Piatto fondo
Teller tief

REF.	Ø _(cm)	H _(cm)	ml	€	MOQ
12238	21	5	874	9,48	6
12242	26	6	1454	12,92	6

Plato oval
Oval plate
Assiette ovale
Piatto ovale
Ovaler teller

REF.	L _(cm)	W _(cm)	€	MOQ
12241	27	16	12,34	4
12240	36	18,5	26,66	4



Bol
Bowl
Bol
Ciotola
Schale

REF.	Ø _(cm)	H _(cm)	ml	€	MOQ
12239	12,5	5	240	3,84	6



Taza
Cup
Tasse
Tazza
Tasse

REF.	Ø _(cm)	H _(cm)	ml	€	MOQ
12243	11	5,7	260	5,12	6



Plato para taza
Cup saucer
Plat pour tasse
Piatto per tazza
Teller für tasse

REF.	Ø _(cm)	H _(cm)	ml	€	MOQ
12244	15	1		4,25	6



NEW



STONEWARE



Plato hondo
Deep plate
Assiette creuse
Piatto fondo
Teller tief

REF.	Ø _(cm)	H _(cm)	ml	€	MOQ
12270	19,5	4,6	550	15,17	6



Plato llano
Flat plate
Assiette plate
Piatto piano
Flacher teller

REF.	Ø _(cm)	H _(cm)	ml	€	MOQ
12271	19	1,5		12,27	6
12272	24	1,5		20,96	6

TORNO



Bol
Bowl
Bol
Ciotola
Schale

REF.	Ø _(cm)	H _(cm)	ml	€	MOQ
12269	13,5	6,3	350	8,46	6



Vaso
Cup
Verre
Vaso
Glas

REF.	Ø _(cm)	H _(cm)	ml	€	MOQ
12268	8	8	200	7,45	6

Plaisir



PLAISIR



La colección PLAISIR está compuesta de platos de porcelana perfectos para servir pequeñas porciones de alimentos, lo que permite una presentación elegante y cuidada de las elaboraciones. Su belleza realza la apariencia de los alimentos, convirtiendo una simple porción de comida en una experiencia culinaria especial.

PLAISIR puede ser utilizado para crear composiciones visuales atractivas en la mesa, combinando diferentes colores y diseños para lograr una estética única. Además, suelen ser parte integral de la vajilla de alta gama, aportando un toque de lujo y sofisticación a cualquier evento o comida.

The PLAISIR collection is composed of porcelain plates that are perfect for serving small portions of food, allowing for an elegant and carefully prepared presentation of food. Its beauty enhances the appearance of the food, turning a simple portion of food into a special culinary experience.

PLAISIR can be used to create attractive visual compositions on the table, combining different colours and patterns to achieve a unique aesthetic. In addition, they are often an integral part of high-end tableware, bringing a touch of luxury and sophistication to any event or meal.





PLAISIR 1.1



REF.	COLOR	W(mm)	L(mm)	H(mm)	€	UE / MOQ
10668	NEGRO	101	82	42	4,35	1-4-72 / 4
10879	BLANCO	101	82	42	4,35	1-4-72 / 4

PLAISIR 1



REF.	COLOR	W(mm)	L(mm)	H(mm)	€	UE / MOQ
10669	NEGRO	81	70	34	3,53	1-4-72 / 4
10880	BLANCO	81	70	34	3,53	1-4-72 / 4



PLAISIR 2



REF.	COLOR	W(mm)	L(mm)	H(mm)	€	UE / MOQ
10670	NEGRO	124	93	35	5,00	1-4-72 / 4
10881	BLANCO	124	93	35	5,00	1-4-72 / 4



PLAISIR 3



REF.	COLOR	W(mm)	L(mm)	H(mm)	€	UE / MOQ
10671	NEGRO	134	55	21	3,97	1-4-72 / 4
10882	BLANCO	134	55	21	3,97	1-4-72 / 4



PLAISIR 4



REF.	COLOR	W(mm)	L(mm)	H(mm)	€	UE / MOQ
10672	NEGRO	116	71	31	4,08	1-4-72 / 4
10883	BLANCO	116	71	31	4,08	1-4-72 / 4



PLAISIR 5



REF.	COLOR	W(mm)	L(mm)	H(mm)	€	UE / MOQ
10673	NEGRO	164	118	43	7,72	1-4-72 / 4
10884	BLANCO	164	118	43	7,72	1-4-72 / 4



PLAISIR 4 XL



REF.	COLOR	W(mm)	L(mm)	H(mm)	€	UE / MOQ
10958	NEGRO	240	145	65	14,40	1-4-24 / 4
10960	BLANCO	240	145	65	14,40	1-4-24 / 4



PLAISIR 5 XL



REF.	COLOR	W(mm)	L(mm)	H(mm)	€	UE / MOQ
10959	NEGRO	247	230	30	14,67	1-4-32 / 4
10961	BLANCO	247	230	30	14,67	1-4-32 / 4



PLAISIR 6



REF.	COLOR	W(mm)	L(mm)	H(mm)	€	UE / MOQ
10674	NEGRO	129	83	39	6,52	1-4-72 / 4
10885	BLANCO	129	83	39	6,52	1-4-72 / 4



PLAISIR 7



REF.	COLOR	W(mm)	L(mm)	H(mm)	€	UE / MOQ
10675	NEGRO	125	114	26	5,00	1-4-72 / 4
10886	BLANCO	125	114	26	5,00	1-4-72 / 4

PLAISIR 8



REF.	COLOR	W(mm)	L(mm)	H(mm)	€	UE / MOQ
10676	NEGRO	124	80	33	6,25	1-4-72 / 4
10887	BLANCO	124	80	33	6,25	1-4-72 / 4



Bol cristal
Glass bowl
Bol en verre
Ciotola in vetro
Kristallkugel

REF.	Ø(mm)	H(mm)	€	UE / MOQ
10788	190	45	15,41	0-4-16 / 4



Bol cristal
Glass bowl
Bol en verre
Ciotola in vetro
Kristallkugel

REF.	Ø(mm)	H(mm)	€	UE / MOQ
10789	150	40	9,50	0-4-48 / 4



Base Cristal L
Glass Dish Amber L
Assiette En Verre L
Piatto In Vetro L
Glasteller L

REF.	L(mm)	W(mm)	€	UE / MOQ
10792	270	170	15,41	0-4-24 / 4



Base Cristal M
Glass Dish Amber M
Assiette En Verre M
Piatto In Vetro M
Glasteller M

REF.	L(mm)	W(mm)	€	UE / MOQ
10793	120	240	12,33	0-4-48 / 4



Base Cristal S
Glass Dish Amber S
Assiette En Verre S
Piatto In Vetro S
Glasteller S

REF.	L(mm)	W(mm)	€	UE / MOQ
10794	120	120	7,96	0-4-96 / 4



Soporte snacks mini
Glass Mini Snack Stand
Support En-Cas En Verre Mini
Supporto Snacks In Vetro Mini
Snack-Theke Mini

REF.	L(mm)	W(mm)	H(mm)	€	UE / MOQ
11797	150	50	35	7,71	0-4-72 / 4



Soporte Snacks Cristal Cuadrado
Glass Square Snack Stand
Support En-Cas En Verre
Supporto Snacks In Vetro
Basso Snack-Theke Glas

REF.	SIZE	L(mm)	W(mm)	H(mm)	€	UE / MOQ
11798	BAJO	120	105	30	7,96	0-4-32 / 4
11799	ALTO	115	115	50	8,22	0-4-32 / 4



Soporte tacos cristal doble
Double glass support
Support double verre
Supporto vetro doppio
Doppelte glshalterung

REF.	L(mm)	W(mm)	H(mm)	€	UE / MOQ
10791	180	60	50	7,90	0-4-24 / 4





Soporte Snacks Cristal rectangular
Glass Oblong Snack Stand
Support En-Cas En Verre Rectangulaire
Supporto Snacks In Vetro rettangolare
Snack-Theke Glas Rechteckig

REF.	SIZE	W(mm)	L(mm)	H(mm)	€	UE / MOQ
11800	BAJO	210	60	28	7,96	0-4-36 / 4
11801	ALTO	210	90	45	8,99	0-4-36 / 4



Plato Tiro Cristal Redondo
Glass Plate Round
Assiette Resto En Verre Ronde
Piatto Tiro In Vetro Rotondo
Runder Glasteller Tiro

REF.	SIZE	Ø(mm)	L(mm)	€	UE / MOQ
11802	S	140	13	7,71	0-4-96 / 4
11803	M	180	13	8,99	0-4-40 / 4
11804	L	220	13	9,76	0-4-40 / 4



Soporte Cristal Redondo 3 Patas
Glass Stand Round 3 Feet
Support En Verre Rond 3 Pieds Su-
pporto In Vetro Rdo 3 Gambe Runder
Glasaufsteller Mit 3 Füßen

REF.	Ø(mm)	L(mm)	€	UE / MOQ
11805	140	13	8,99	0-4-96 / 4



Teja Cristal Ambar
Patterned Glass Amber Roof Tile
Assiette Tuile En Verre Ambre
Tegola Di Vetro Ambar
Glasziegel Bernstein

REF.	W(mm)	L(mm)	€	UE / MOQ
11943	300	90	12,33	0-4-48 / 4

Zigzac 2 Tacos
Zigzag 2 Tacos
Zigzag 2 Tacos
Zigzag 2 Tacos
Zigzag 2 Tacos



REF.	W(mm)	L(mm)	H(mm)	€	UE / MOQ
11806	140	130	18	8,73	0-4-48 / 4

Zigzac 4 Tacos
Zigzag 4 Tacos
Zigzag 4 Tacos
Zigzag 4 Tacos
Zigzag 4 Tacos



REF.	W(mm)	L(mm)	H(mm)	€	UE / MOQ
11807	140	250	18	11,05	0-4-32 / 4





Mini vaso
Mini cup
Mini verre
Mini vaso
Dipschälchen klein



REF.	Ø _(mm)	L _(mm)	ml	€	UE / MOQ
7625	50	40	2,5	1,56	1-6-144 / 6

Mini tarrina
Mini ramekin
Mini pôt
Mini terrina
Dipschälchen groß



REF.	Ø _(mm)	H _(mm)	€	UE / MOQ
7626	80	25	2,06	1-6-144 / 6

Mini sartén
Mini pan
Mini poêle
Mini padella
Mini pfanne



REF.	Ø _(mm)	L _(mm)	H _(mm)	€	UE / MOQ
7627	90	140	22	4,37	1-6-72 / 6

Mini bandeja
Mini tray
Mini plateau
Mini vassoio
Mini platte



REF.	W _(mm)	L _(mm)	H _(mm)	€	UE / MOQ
7629	80	155	10	3,72	1-6-72 / 6

Mini caja M
Mini box M
Mini Boîte M
Mini Cassetta M
Behälter M



REF.	W _(mm)	L _(mm)	H _(mm)	€	UE / MOQ
7621	80	120	70	6,78	1-6-36 / 6

Mini parrilla
Mini grill plate
Mini grill
Mini graticola
Mini gratin platte



REF.	Ø _(mm)	L _(mm)	H _(mm)	€	UE / MOQ
7624	90	125	20	2,91	1-6-144 / 6

Mini cazuela
Mini casserole
Mini casserole
Mini casseruola
Mini kasserolle



REF.	W _(mm)	L _(mm)	H _(mm)	€	UE / MOQ
7628	90	130	25	3,42	1-6-72 / 6

Mini olla
Mini pot
Mini-pot
Mini pentola
Mini topf



REF.	Ø _(mm)	L _(mm)	H _(mm)	ml	€	UE / MOQ
7630	100	140	90	250	10,35	1-6-36 / 6



Peana

Base
Base
Base
Basis

REF.	COLOR	Ø(mm)	H(mm)	€	UE / MOQ
11591	○	155	84	14,32	1-3-24 / 3
11592	●	155	84	14,32	1-3-24 / 3



Peana oval blanca

Base oval white
Base ovale blanc
Base ovale bianca
Basis ovale weiss

REF.	W(mm)	L(mm)	H(mm)	€	UE / MOQ
11593	309	168	88	31,15	1-3-9 / 3



Dim Sum S

REF.	Ø(mm)	€	UE / MOQ
11588	128	33,91	1-1-18 / 1



Dim Sum L

REF.	Ø(mm)	€	UE / MOQ
11590	186	49,79	1-1-12 / 1





Pioli x Comas

Diseños exclusivos para la hostelería profesional que complementan nuestra oferta

Desde Comas siempre intentamos ir más allá. En esta constante búsqueda de nuevas soluciones que permitan brindar experiencias extraordinarias en la sala, y que complementen nuestra amplia gama de diseños en cubertería, chuleteros y nuestra propia vajilla, presentamos una selección de productos de porcelana y stoneware de Pioli, diseños en exclusiva para el canal de la hostelería profesional.

Pioli aporta vanguardia y modernidad, junto con la sólida herencia de unos de los principales productores de porcelana del mundo: Porland.

Esta selección de productos que ahora ofrecemos desde Comas, se convierte en un paso más en nuestra incansable búsqueda de lo extraordinario.

Pioli x Comas

Exclusive designs for the professional hospitality industry that complement our offer

At Comas we always try to go further. In this constant search for new solutions that allow us to provide extraordinary experiences in the dining room, and that complement our wide range of designs in cutlery, steak knives and our own crockery, we present a selection of Pioli porcelain and stoneware products, designs exclusively for the professional foodservice channel.

Pioli brings cutting-edge design and modernity, along with the solid legacy of one of the world's leading porcelain producers: Porland.

This selection of products now offered by Comas is just another step in our tireless search for the extraordinary.



RE-GEN transforma residuos cerámicos en **diseño sostenible**. Piezas rotas, defectuosas o fuera de estándar se convierten en una colección 100 % reciclada, reduciendo la huella de carbono y dando nueva vida a lo descartado.

Cada pieza RE-GEN refleja innovación, sostenibilidad y respeto por el planeta.

RE-GEN turns ceramic waste into **sustainable design**. Broken, defective, or non-standard pieces are transformed into a 100% recycled collection, reducing carbon footprint and giving new life to discarded materials.

Each RE-GEN piece reflects innovation, sustainability, and respect for the planet.



5

Plato Llano Coupé
Coupe Flat Plate
Assiette Plate Coupe
Piatto Piano Coupe
Coupe-Flacher Teller

REF.	Ø _(cm)	€	MOQ
ON12374	15	3,25	24
ON12375	18	4,28	6
ON12376	21	5,03	6
ON12377	27	7,85	6



Plato Hondo
Deep Plate
Assiette Creuse
Piatto Fondo
Teller Tieft

REF.	Ø _(cm)	cc	€	MOQ
ON12405	22	835	7,17	6



Bol
Bowl
Bol
Ciotola
Schale

REF.	Ø _(cm)	cc	€	MOQ
ON12382	8	120	2,35	6
ON12379	9	95	2,75	24
ON12381	13	260	3,39	6
ON12378	17	415	4,89	6



5

Bandeja
Tray
Plateau
Vassoio
Tablett

REF.	L _(cm)	€	MOQ
ON12380	32	10,77	6



PIOLI



Plato Llano Coupé
Coupe Flat Plate
Assiette Plate Coupe
Piatto Piano Coupe
Coupe-Flacher Teller

REF.	Ø _(cm)	€	MOQ
MO18BJ18	18	4,64	24
MO18BJ21	21	6,32	24
MO18BJ23	23	8,21	12
MO18BJ27	27	10,07	6

Plato Hondo Coupé
Coupé Deep Plate
Assiette Creuse Coupé
Piatto Fondo Coupé
Coupe-Tief Teller

REF.	Ø _(cm)	cc	€	MOQ
MO178325	25	1250	15,72	6
MO178328	28	1800	20,84	6

Bandeja
Tray
Plateau
Vassoio
Tablett

REF.	L _(cm)	€	MOQ
MO118427	27	8,73	6
MO118432	32	12,48	6



Plato Llano Coupé
Coupe Flat Plate
Assiette Plate Coupe
Piatto Fondo Coupe
Coupe-Flacher Teller

REF.	Ø _(cm)	€	MOQ
GL18BJ18	18	4,64	24
GL18BJ21	21	6,32	24
GL18BJ23	23	8,21	12
GL18BJ27	27	10,07	6

Plato Hondo Coupé
Coupé Deep Plate
Assiette Creuse Coupé
Piatto Fondo Coupé
Coupe-Tief Teller

REF.	Ø _(cm)	cc	€	MOQ
GL178325	25	1250	15,72	6
GL178328	28	1800	20,84	6

Bol
Bowl
Bol
Ciotola
Schale

REF.	Ø _(cm)	cc	€	MOQ
GL352708	8	120	2,82	48
GL36DC14	14	420	6,87	4
GL36DC17	17	585	8,73	6



Bandeja
Tray
Plateau
Vassoio
Tablett

REF.	L _(cm)	€	MOQ
GL118427	27	8,73	6
GL118432	32	12,48	6



PIOLI



Plato Llano Coupé
Coupe Flat Plate
Assiette Plate Coupe
Piatto Piano Coupe
Coupe-Flacher Teller

REF.	Ø _(cm)	€	MOQ
SIE18BJ18	18	4,64	24
SIE18BJ21	21	6,32	24
SIE18BJ23	23	8,21	12
SIE18BJ27	27	10,07	6

Plato Hondo Coupé
Coupé Deep Plate
Assiette Creuse Coupé
Piatto Fondo Coupé
Coupe-Tief Teller

REF.	Ø _(cm)	cc	€	MOQ
SIE178325	25	1250	15,72	6

Bandeja
Tray
Plateau
Vassoio
Tablett

REF.	L _(cm)	€	MOQ
SIE118427	27	8,73	6
SIE118432	32	12,48	6



Plato pizza
Pizza Plate
Assiette à Pizza
Piatto Pizza
PizzaTeller

REF.	Ø _(cm)	€	MOQ
ARV162932	32	16,69	6

Plato Llano Coupé
Coupe Flat Plate
Assiette Plate Coupe
Piatto Piano Coupe
Coupe-Flacher Teller

REF.	Ø _(cm)	€	MOQ
ARV18ML17	17	4,32	36
ARV18ML21	21	6,28	6
ARV18ML23	23	7,67	6
ARV18ML27	27	9,98	6

Plato Hondo Coupé
Deep Plate
Assiette Creuse
Piatto Fondo
Teller Tief

REF.	Ø _(cm)	cc	€	MOQ
ARV17ML20	20	530	6,49	6
ARV17ML26	26	1250	12,55	6



Plato pasta
Bowl
Bol
Ciotola
Schale

REF.	Ø _(cm)	cc	€	MOQ
ARV173925	26	300	13,41	6

Bol
Bowl
Bol
Ciotola
Schale

REF.	Ø _(cm)	cc	€	MOQ
ARV368109	10	95	3,78	24
ARV36ML16	16	430	6,49	6



Bandeja Ovalada
Oval Plate
Assiette Ovale
Piatto Ovale
Ovaler Teller

REF.	L _(cm)	€	MOQ
ARV11ML20	20	7,06	48
ARV11ML25	25	9,02	6
ARV11ML30	30	11,31	6

ORIENTAL

PORCELANA / PORCELAIN



Plato Llano Coupé
Coupe Flat Plate
Assiette Plate Coupe
Piatto Piano Coupe
Coupe-Flacher Teller

REF.	Ø _(cm)	€	MOQ
OR18ML15	15	3,32	36
OR18ML17	17	4,03	36
OR18ML21	21	5,89	6
OR18ML23	23	7,17	6
OR18ML27	27	9,74	6
OR18ML30	30	12,88	6



Plato Hondo
Deep Plate
Assiette Creuse
Piatto Fondo
Teller Tief

REF.	Ø _(cm)	cc	€	MOQ
OR17ML26	26	1250	11,77	6



Bol
Bowl
Bol
Ciotola
Schale

REF.	Ø _(cm)	cc	€	MOQ
OR36ML16	16	430	6,06	6



Plato Ovalado
Oval Plate
Assiette Ovale
Piatto Ovale
Ovaler Teller

REF.	L _(cm)	€	MOQ
OR11ML30	30	10,59	6
OR11ML34	34	16,01	6

PORCELANA / PORCELAIN

NEPTUNE



Plato Llano Coupé
Coupe Flat Plate
Assiette Plate Coupe
Piatto Piano Coupe
Coupe-Flacher Teller

REF.	Ø _(cm)	€	MOQ
NE18ML15	15	3,32	36
NE18ML17	17	4,03	36
NE18ML21	21	5,89	6
NE18ML23	23	7,17	6
NE18ML27	27	9,56	6
NE18ML30	30	12,88	6



Plato Llano
Flat Plate
Assiette Plate
Piatto Piano
Flacher Teller

REF.	Ø _(cm)	€	MOQ
NE18AP16	16	5,14	6
NE18AP21	21	6,96	6
NE18AP24	24	9,81	6
NE18AP27	27	12,34	6



Plato Pizza
Pizza Plate
Assiette à Pizza
Piatto Pizza
PizzaTeller

REF.	Ø _(cm)	€	MOQ
NE162932	32	15,62	6



Plato para pasta y ensalada
Pasta & Salad Plate
Assiette à Pâtes et Salade
Piatto Pasta & Insalata
Pasta & Salatteller

REF.	Ø _(cm)	cc	€	MOQ
NE173925	26	300	12,55	6



Plato Hondo Coupé
Coupé Deep Plate
Assiette Creuse Coupé
Piatto Fondo Coupé
Coupe-Tief Teller

REF.	Ø _(cm)	cc	€	MOQ
NE17AP25	25	1250	15,62	6
NE17AP28	28	1800	20,76	6



Plato Ovalado
Oval Plate
Assiette Ovale
Piatto Ovale
Ovaler Teller

REF.	L _(cm)	€	MOQ
NE11AP21	21	5,17	6
NE11AP30	30	10,52	6
NE11AP34	34	17,23	6



Bol
Bowl
Bol
Ciotola
Schale

REF.	Ø _(cm)	cc	€	MOQ
NE36ML16	16	430	6,06	6



ZENIT



Plato Llano Coupé

Coupe Flat Plate
Assiette Plate Coupe
Piatto Piano Coupe
Coupe-Flacher Teller

REF.	Ø(cm)	€	MOQ
ZE18ML15	15	3,32	36
ZE18ML17	17	4,03	36
ZE18ML21	21	5,89	6
ZE18ML23	23	7,17	6
ZE18ML27	27	9,74	6
ZE18ML30	30	12,88	6



Plato Llano

Flat Plate
Assiette Plate
Piatto Piano
Flacher Teller

REF.	Ø(cm)	€	MOQ
ZE18AP16	16	5,14	6
ZE18AP21	21	6,96	6
ZE18AP24	24	9,81	6
ZE18AP27	27	12,34	6



Plato Pizza

Pizza Plate
Assiette à Pizza
Piatto Pizza
PizzaTeller

REF.	Ø(cm)	€	MOQ
ZE162932	32	15,62	6



Plato para pasta y ensalada

Pasta & Salad Plate
Assiette à Pâtes et Salade
Piatto Pasta & Insalata
Pasta & Salatteller

REF.	Ø(cm)	cc	€	MOQ
ZE173925	26	300	12,55	6



Plato Hondo Coupé

Coupé Deep Plate
Assiette Creuse Coupé
Piatto Fondo Coupé
Coupe-Tief Teller

REF.	Ø(cm)	cc	€	MOQ
ZE17AP25	25	1250	15,62	6
ZE17AP28	28	1800	20,76	6



Plato Ovalado

Oval Plate
Assiette Ovale
Piatto Ovale
Ovaler Teller

REF.	L(cm)	€	MOQ
ZE11AP21	21	5,17	6
ZE11AP30	30	10,52	6
ZE11AP34	34	17,23	6



Plato Llano Coupé

Coupe Flat Plate
Assiette Plate Coupe
Piatto Piano Coupe
Coupe-Flacher Teller

REF.	Ø(cm)	€	MOQ
SA18ML15	15	3,83	36
SA18ML17	17	4,64	36
SA18ML21	21	6,95	6
SA18ML23	23	8,62	6
SA18ML27	27	12,26	6
SA18ML30	30	16,09	6



Plato Llano

Flat Plate
Assiette Plate
Piatto Piano
Flacher Teller

REF.	Ø(cm)	€	MOQ
SA18AP16	16	5,76	6
SA18AP21	21	7,84	6
SA18AP24	24	11,18	6
SA18AP27	27	14,23	6



Plato Pizza

Pizza Plate
Assiette à Pizza
Piatto Pizza
PizzaTeller

REF.	Ø(cm)	€	MOQ
SA162932	32	18,76	6



Plato para pasta y ensalada

Pasta & Salad Plate
Assiette à Pâtes et Salade
Piatto Pasta & Insalata
Pasta & Salatteller

REF.	Ø(cm)	cc	€	MOQ
SA173924	25	300	11,07	6



Plato Hondo

Deep Plate
Assiette Creuse
Piatto Fondo
Teller Tief

REF.	Ø(cm)	cc	€	MOQ
SA17ML20	20	530	7,28	6
SA17ML26	26	1250	14,53	6



Plato Hondo Coupé

Coupé Deep Plate
Assiette Creuse Coupé
Piatto Fondo Coupé
Coupe-Tief Teller

REF.	Ø(cm)	cc	€	MOQ
SA17AP28	28	1800	24,11	6



Bol

Bowl
Bol
Ciotola
Schale

REF.	Ø(cm)	cc	€	MOQ
ZE173925	16	430	6,06	6



Plato Ovalado

Oval Plate
Assiette Ovale
Piatto Ovale
Ovaler Teller

REF.	L(cm)	€	MOQ
SA11AP21	21	6,32	6
SA11AP30	30	12,04	6
SA11AP34	34	18,87	6



Bol Apilable

Stackable Bowl
Empilable Bol
Impilable Ciotola
Stapelbare Schale

REF.	Ø(cm)	cc	€	MOQ
SA36AP16	16	480	10,22	6



Bol

Bowl
Bol
Ciotola
Schale

REF.	Ø(cm)	cc	€	MOQ
SA36ML16	16	430	7,10	6



PORCELANA / PORCELAIN

PORCELANA / PORCELAIN

SAKURA



PIOLI



Plato Llano Coupé
Coupe Flat Plate
Assiette Plate Coupe
Piatto Piano Coupe
Coupe-Flacher Teller

REF.	Ø(cm)	€	MOQ
OL18ML15	15	3,83	36
OL18ML17	17	4,64	36
OL18ML21	21	6,95	6
OL18ML23	23	8,62	6
OL18ML27	27	12,26	6
OL18ML30	30	16,09	6



Plato Llano
Flat Plate
Assiette Plate
Piatto Piano
Flacher Teller

REF.	Ø(cm)	€	MOQ
OL18AP16	16	5,76	6
OL18AP21	21	7,84	6
OL18AP24	24	11,18	6
OL18AP27	27	14,23	6



Plato Pizza
Pizza Plate
Assiette à Pizza
Piatto Pizza
PizzaTeller

REF.	Ø(cm)	€	MOQ
OL162932	32	18,76	6



Plato para pasta y ensalada
Pasta & Salad Plate
Assiette à Pâtes et Salade
Piatto Pasta & Insalata
Pasta & Salatteller

REF.	Ø(cm)	cc	€	MOQ
OL173924	25	300	11,07	6



Plato Hondo
Deep Plate
Assiette Creuse
Piatto Fondo
Teller Tief

REF.	Ø(cm)	cc	€	MOQ
OL17ML20	20	530	7,28	6
OL17ML26	26	1250	14,53	6



Plato Hondo Coupé
Coupé Deep Plate
Assiette Creuse Coupé
Piatto Fondo Coupé
Coupe-Tief Teller

REF.	Ø(cm)	cc	€	MOQ
OL17AP28	28	1800	24,11	6



Bol
Bowl
Bol
Ciotola
Schale

REF.	Ø(cm)	€	MOQ
OL36AP14	14	9,10	6



Bol Apilable
Stackable Bowl
Empilable Bol
Impilable Ciotola
Stapelbare Schale

REF.	Ø(cm)	cc	€	MOQ
OL36AP16	16	480	10,22	6



Bol
Bowl
Bol
Ciotola
Schale

REF.	Ø(cm)	cc	€	MOQ
OL36ML16	16	430	7,10	6
OL36ML18	18	750	9,40	6



Plato Ovalado
Oval Plate
Assiette Ovale
Piatto Ovale
Ovaler Teller

REF.	L(cm)	€	MOQ
OL11AP21	21	6,32	6
OL11AP30	30	12,04	6
OL11AP34	34	18,87	6





PORCELANA / PORCELAIN



Plato Pizza
Pizza Plate
Assiette à Pizza
Piatto Pizza
PizzaTeller

REF.	Ø(cm)	€	MOQ
MI162932	32	13,74	6



Plato Llano Coupé
Coupe Flat Plate
Assiette Plate Coupe
Piatto Piano Coupe
Coupe-Flacher Teller

REF.	Ø(cm)	€	MOQ
MI18ML15	15	2,90	36
MI18ML17	17	3,21	36
MI18ML21	21	4,59	6
MI18ML23	23	5,66	6
MI18ML27	27	7,56	6
MI18ML30	30	10,70	6



Plato para pasta y ensalada
Pasta & Salad Plate
Assiette à Pâtes et Salade
Piatto Pasta & Insalata
Pasta & Salatteller

REF.	Ø(cm)	€	MOQ
MI173927	27	11,42	6



Plato Hondo
Deep Plate
Assiette Creuse
Piatto Fondo
Teller Tief

Deep Plate

REF.	Ø(cm)	cc	€	MOQ
MI17ML20	20	530	5,07	6
MI17ML26	26	1250	9,66	6



Plato Ovalado
Oval Plate
Assiette Ovale
Piatto Ovale
Ovaler Teller

Oval Plate

REF.	L(cm)	€	MOQ
MI11ML25	25	6,97	6
MI11ML30	30	8,77	6
MI11ML34	34	13,74	6



Bol
Bowl
Bol
Ciotola
Schale

Bowl

REF.	Ø(cm)	cc	€	MOQ
MI36ML18	18	750	6,49	6



Taza café apilable y plato coupé
Stackable Coffee Cup & Coupe Saucer
Tasse à Café Empilable et Soucoupe Coupe
Tazza Caffè con Piattino Impilabile
Stapelbare Kaffeetasse & Coupe-Untertasse

REF.	cm	cc	€	MOQ
MI31ML08		85	4,07	6
MI12ML12	12		2,66	24



Taza té/café apilable y plato coupé
Stackable Tea/Coffee Cup & Coupe Saucer
Tasse à Café Empilable et Soucoupe Coupe
Tazza Caffè con Piattino Impilabile
Stapelbare Kaffeetasse & Coupe-Untertasse

REF.	cm	cc	€	MOQ
MI32ML21		220	5,28	6
MI13ML16	16		3,73	6



PIOLI



Plato Llano Coupé
Coupe Flat Plate
Assiette Plate Coupe
Piatto Piano Coupe
Coupe-Flacher Teller

REF.	Ø(cm)	€	MOQ
MA12394	20	5,12	6
MA12395	24	7,72	6
MA12396	26	10,59	6



Plato Hondo
Deep Plate
Assiette Creuse
Piatto Fondo
Teller Tief

REF.	Ø(cm)	cc	€	MOQ
MA12398	22	230	7,76	6



Bol
Bowl
Bol
Ciotola
Schale

REF.	Ø(cm)	cc	€	MOQ
MA12399	16	285	4,93	24
MA12400		400	6,76	24



Taza té/café apilable y plato coupé
Stackable Tea/Coffee Cup & Coupe Saucer
Tasse à Café Empilable et Soucoupe Coupe
Tazza Caffè con Piattino Impilabile
Stapelbare Kaffeetasse & Coupe-Untertasse

REF.	cm	cc	€	MOQ
MA12401		180	5,08	6
MA12402	16		4,17	36



Taza café apilable y plato coupé
Stackable Coffee Cup & Coupe Saucer
Tasse à Café Empilable et Soucoupe Coupe
Tazza Caffè con Piattino Impilabile
Stapelbare Kaffeetasse & Coupe-Untertasse

REF.	cm	cc	€	MOQ
MA12403		80	3,86	6
MA12404	12		2,68	24



Plato Llano
Flat Plate
Assiette Plate
Piatto Piano
Flacher Teller

REF.	Ø(cm)	€	MOQ
PL18AP16	16	4,00	6
PL18AP21	21	5,45	6
PL18AP24	24	7,77	6
PL18AP27	27	9,80	6



Plato Hondo Coupé
Coupé Deep Plate
Assiette Creuse Coupé
Piatto Piano Coupé
Coupe-Tief Teller

REF.	Ø(cm)	cc	€	MOQ
PL17AP25	25	1250	13,88	6
PL17AP28	28	1800	19,02	6



Bol
Bowl
Bol
Ciotola
Schale

REF.	Ø(cm)	cc	€	MOQ
PL36AP16	16	480	7,32	6



Plato Ovalado
Oval Plate
Assiette Ovale
Piatto Ovale
Ovaler Teller

REF.	cm	€	MOQ
PL11AP21	21	4,52	6
PL11AP30	30	9,18	6
PL11AP34	34	15,46	6



PIOLI



Plato Hondo
Deep Plate
Assiette Creuse
Piatto Fondo
Teller Tief

REF.	cm	cc	€	MOQ
HAN17HA23	22	1000	10,49	6
HAN17HA26	26	1250	15,02	6



Bol
Bowl
Bol
Ciotola
Schale

REF.	cm	cc	€	MOQ
HAN36HA18	17	600	6,85	6



Plato Llano Coupé
Coupe Flat Plate
Assiette Plate Coupe
Piatto Piano Coupe
Coupe-Flacher Teller

REF.	cm	€	MOQ
HAL18TT27	27	9,34	6



Plato Hondo
Deep Plate
Assiette Creuse
Piatto Fondo
Teller Tief

REF.	cm	cc	€	MOQ
HAL17TT20	20	830	7,99	6



Plato Ovalado
Oval Plate
Assiette Ovale
Piatto Ovale
Ovaler Teller

REF.	cm	€	MOQ
HAL11TT36	36	14,27	6



PIOLI



VITRIFICACIÓN Y COCCIÓN
VITRIFICATION & FIRING

La vitrificación de la porcelana Pioli garantiza máxima durabilidad y 0 % de absorción, ideal para uso intensivo en hostelería.

Pioli's vitrified porcelain ensures top durability and 0% absorption, perfect for intensive hospitality use.



INNOVACIÓN EN EL DISEÑO
DESIGN INNOVATION

Pioli combina diseño moderno y sofisticación, creando productos elegantes, funcionales e innovadores para el sector hostelero.

Pioli blends modern design with sophistication, offering elegant, functional, and innovative products tailored to the hospitality industry.



APTO PARA LAVAVAJILLAS
DISHWASHER SAFE

Los productos Pioli conservan su brillo y calidad tras múltiples lavados gracias a su esmalte y estructura resistente al lavavajillas.

Pioli products maintain their shine and quality after repeated washes thanks to their dishwasher-resistant glaze and structure.



RESISTENCIA AL CHOQUE TÉRMICO
THERMAL SHOCK RESISTANCE SAFE

Los productos Pioli resisten cambios térmicos de hasta 180 °C, ideales para uso en frío y calor: congeladores, microondas y hornos.

Pioli products withstand temperature shifts up to 180 °C, making them safe for freezers, microwaves, and ovens.



ESMALTADO GLAZING

Nuestros esmaltes transparente y mate protegen contra arañazos y desgaste, manteniendo el brillo hasta 4 veces más que los productos estándar.

Our transparent and matte glazes protect against scratches and wear, preserving shine up to 4 times longer than standard products.



DISEÑO APILABLE
STACKABLE DESIGN

Los diseños apilables de Pioli optimizan el almacenamiento, ideales para hoteles y restaurantes.

Pioli's stackable designs maximize storage efficiency, perfect for hotels and restaurants.



CALIDAD Y CONFORMIDAD
QUALITY & CONFORMANCE

Pioli cumple con los más altos estándares, garantizando productos confiables y de calidad constante.

Pioli meets the highest standards, ensuring consistently reliable and high-quality products.



APTO PARA MICROONDAS
MICROWAVE SAFE

Los productos Pioli resisten el uso en microondas hasta 1300 W sin grietas ni roturas.

Pioli products are microwave-safe up to 1300 W, without cracking or breaking.



TRANSLUCIDEZ
TRANSLUCENCY

Las porcelanas Pioli, finas y translúcidas, aportan elegancia y sofisticación al transmitir la luz con sutileza.

Pioli's thin, translucent porcelain adds elegance and sophistication by gracefully transmitting light.



VENTAJA DE STOCK
READY TO SHIP INVENTORY

Pioli mantiene stock amplio para asegurar entregas rápidas y continuidad operativa en el sector HoReCa.

Pioli keeps a large inventory to ensure fast delivery and uninterrupted service in the HoReCa sector.



GARANTÍA DE DESPORTILLADO DEL BORDE
EDGE CHIP GUARANTEE

Los productos de porcelana Pioli ofrecen un rendimiento resistente y robusto gracias a las fases compuestas de composiciones gracias a las fases compuestas de composiciones de materias primas diseñadas.

Las pruebas contra el astillado de bordes de nuestros productos, garantizados con una garantía de 5 años contra el astillado de bordes, se determinan según los estándares nacionales e internacionales en función de sus formas estructurales.

Pioli porcelain products offer durable and robust performance thanks to the composite phases of their compositions, which are designed using specially selected raw materials.

The edge chipping tests on our products, which come with a 5-year guarantee against edge chipping, are determined according to national and international standards based on their structural shapes.



Plato Pizza
Pizza Plate
Assiette à Pizza
Piatto Pizza
PizzaTeller

REF.	Ø(cm)	€	MOQ
AL12406	32	9,98	6



Plato Llano
Flat Plate
Assiette Creuse
Piatto Piano
Flacher Teller

REF.	Ø(cm)	€	MOQ
AL12383	17	2,45	36
AL12384	21	3,66	6
AL12385	25	4,97	6
AL12386	28	6,42	6
AL12387	31	9,15	6



Plato Hondo
Deep Plate
Assiette Creuse
Piatto Fondo
Teller Tief

REF.	Ø(cm)	cc	€	MOQ
AL12388	25	800	8,42	6
AL12389	31	850	12,94	6



Bol apilable
Bowl
Bol
Ciotola
Schale

REF.	Ø(cm)	cc	€	MOQ
AL12390	12	350	3,93	6



Taza y plato
Coffee Cup & Coupe Saucer
Tasse à Café et Soucoupe Coupe
Tazza Caffè con Piattino
Kaffeetasse & Coupe-Untertasse

REF.	cc	€	MOQ
AL12393	85	5,35	12
AL12392	155	6,35	6
AL12391	200	7,01	6



TABLE TOP

PRESENTACIÓN

PRESENTATION

- 280 BAUHAUS
- 282 TABLAS PRESENTACIÓN

MINIATURAS

MINIATURES

- 284 INOX Y COBRE
- 286 FREIDORAS
- 287 PAPEL ANTIGRASA
- 288 HIERRO FUNDIDO
- 290 HIERRO ESMALTADO
- 292 VAPORERAS
- 293 CAJAS MADERA

SERVICIO MESA

TABLE TOP

- 294 CHAMPAGNERAS
- 296 PANERAS
- 298 VINAGRERAS
- 300 BANDEJAS
- 302 COCTELERIA Y ACCESORIOS



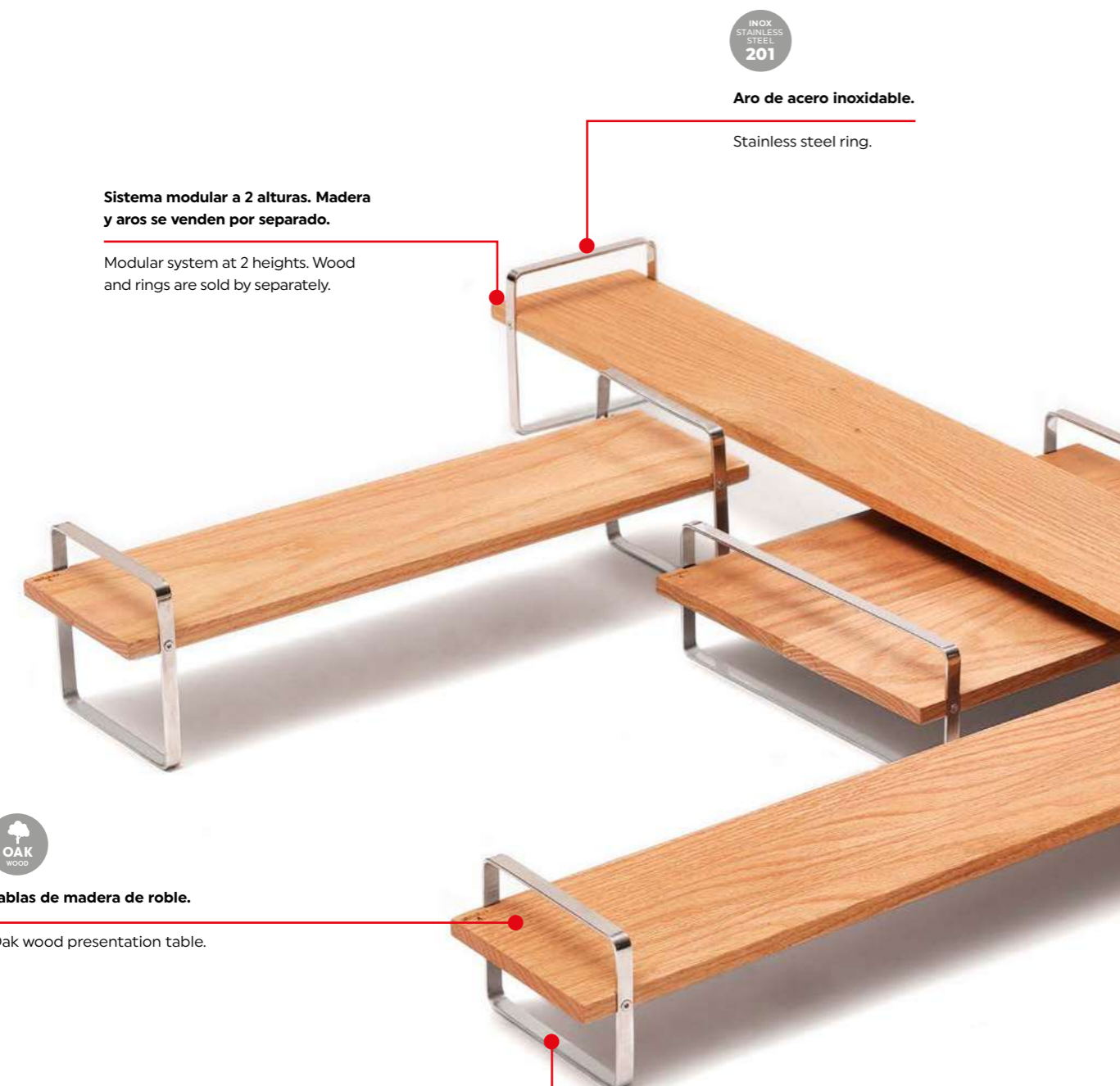

INOX
STAINLESS
STEEL
201

Aro de acero inoxidable.
Stainless steel ring.

Sistema modular a 2 alturas. Madera y aros se venden por separado.

Modular system at 2 heights. Wood and rings are sold by separately.



Tablas de madera de roble.

Oak wood presentation table.

Escoge la medida de la tabla de madera y la altura de los aros para personalizar tu tabla de presentación.

Choose the size of the wooden board and the height of the hoops to customize your presentation board.



Las tablas vienen preparadas con una muesca para encajar y atornillar los aros.

The tables come prepared with a notch to fit and screw the rings.



Tabla presentación

Wooden table for table service
Table en bois pour service de table
Tavolo in legno per servizio a tavola
Holztisch für tischservice

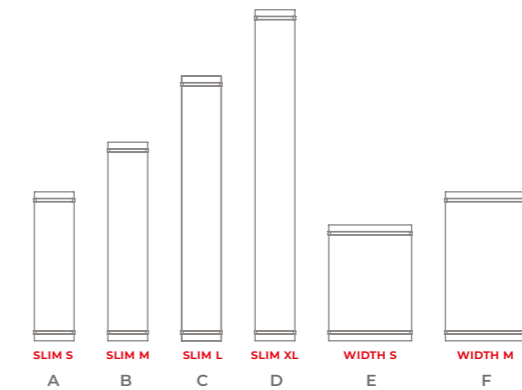

REF.	MODELO	W(mm)	L(mm)	H(mm)	AROS COMPATIBLES CON / COMPATIBLE RINGS	€	UE / MOQ
A 9985	SLIM S	120	450	15	10648, 10649	12,32	1-0-24 / 1
B 9986	SLIM M	120	600	15	10648, 10649	15,83	1-0-20 / 1
C 9987	SLIM L	120	800	15	10648, 10649	20,40	1-0-12 / 1
D 9988	SLIM XL	120	1000	15	10648, 10649	25,01	1-0-10 / 1
E 9989	WIDTH S	250	350	15	10719, 10720	37,21	1-0-16 / 1
F 9990	WIDTH M	250	450	15	10719, 10720	23,58	1-0-12 / 1



Pack 2 Aros

Pack 2 st/st ring
Pack 2 anneau en acier
Pack 2 anello in acciaio
Pack 2 stahlring

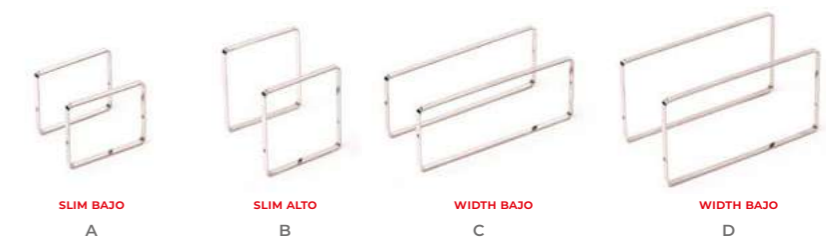

REF.	L(mm)	H(mm)	COMPATIBLES CON TABLA / COMPATIBLE WITH TABLE	€	UE / MOQ
A 10648	120	90	SLIM	8,17	1-15-60 / 1
B 10649	120	120	SLIM	8,53	1-15-60 / 1
C 10719	250	90	WIDTH	9,86	1-15-60 / 1
D 10720	250	120	WIDTH	10,50	1-15-60 / 1

ESCOGE TU KIT / CHOOSE YOUR KIT



REF.	REF. TABLA + REF. ARO	DESCRIPCIÓN	€	UE / MOQ
11170	9985 10648	Tabla Slim S + Aro Slim Bajo	20,49	1-0-0 / 1
11171	9985 10649	Tabla Slim S + Aro Slim Alto	20,85	1-0-0 / 1
11172	9986 10648	Tabla Slim M + Aro Slim Bajo	24,00	1-0-0 / 1
11173	9986 10649	Tabla Slim M + Aro Slim Alto	24,36	1-0-0 / 1
11174	9987 10648	Tabla Slim L + Aro Slim Bajo	28,57	1-0-0 / 1
11175	9987 10649	Tabla Slim L + Aro Slim Alto	28,93	1-0-0 / 1
11176	9988 10648	Tabla Slim XI + Aro Slim Bajo	33,18	1-0-0 / 1
11177	9988 10649	Tabla Slim XI + Aro Slim Alto	33,54	1-0-0 / 1
11178	9989 10719	Tabla Width S + Aro Width Bajo	47,07	1-0-0 / 1
11179	9989 10720	Tabla Width S + Aro Width Alto	47,71	1-0-0 / 1
11180	9990 10719	Tabla Width M + Aro Width Bajo	9,86	1-0-0 / 1
11181	9990 10720	Tabla Width M + Aro Width Alto	34,09	1-0-0 / 1



Tabla madera
Wooden table
Table en bois
Tavolo in legno
Eichenholztisch



REF.	W(mm)	L(mm)	H(mm)	€	UE / MOQ
11016	230	330	20	14,00	1-0-10 / 1
11017	280	390	20	19,45	1-0-10 / 1



Bandeja madera bambú
Bamboo tray
Plateau en bambou
Vassoio in bambù
Bambus-tablett



* En caso de poner comida directamente en la bandeja, recomendamos el uso de papel antigrasa.
If food is placed directly on the tray, we recommend the use of greaseproof paper.

REF.	W(mm)	L(mm)	H(mm)	€	UE / MOQ
10998	100	200	30	4,75	1-10-40 / 1
10999	200	300	30	8,45	1-10-20 / 1
11000	300	400	30	11,87	1-0-10 / 1
11001	320	530	45	18,38	1-0-10 / 1



Pizarra + Base acacia
Slate board +Acacia base
Ardoise + Socle acacia
Ardesia + Base in acacia
Schiefer + Basis aus akazie



* Acabado brillo / Gloss finish

REF.	W(mm)	L(mm)	H(mm)	€	UE / MOQ
11574	345	550	20	40,43	1-0-0 / 1
11575	285	340	15	21,06	1-0-0 / 1
11576	195	340	15	16,70	1-0-0 / 1
11577	320	320	15	21,52	1-0-0 / 1



Pizarra
Slate board
Ardoise
Ardesia
Schiefer



REF.	FORMATO	W(mm)	L(mm)	L(mm)	€	UE / MOQ
11002	1/1	530	325	5	8,81	1-0-6 / 1
11003	1/2	325	265	5	5,14	1-0-10 / 1
11004	1/3	325	175	5	4,08	1-0-15 / 1
11572		300	300	5	5,46	1-0-10 / 1

Compatible con /
COMPATIBLE WITH:
11005, 11006, 11007, 11573

Base madera para pizarra
Base for slate tray
Socle pour plateau ardoise
Base per vassoio in ardesia
Basis für schieferfach



REF.	W(mm)	L(mm)	H(mm)	€	UE / MOQ
11005	345	550	20	32,91	1-0-10 / 1
11006	285	345	15	16,57	1-0-20 / 1
11007	195	345	15	13,14	1-0-40 / 1
11573	320	320	15	16,72	1-0-20 / 1

Compatible con /
COMPATIBLE WITH:
11002, 11003, 11004, 11572

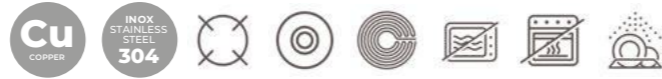

Capa interior acero inoxidable. Total seguridad para el contacto alimentario.

Stainless steel interior.
Food contact total security.

Asas de bronce.

Brass handles.



CONDUCTIVIDAD TÉRMICA

Capa exterior cobre.

Facilita la cocción gracias a que este material ayuda a crear una distribución uniforme del calor por toda la superficie.

Copper exterior.

Facilitates the cooking because this material helps to create a uniform distribution of heat on all the surface.

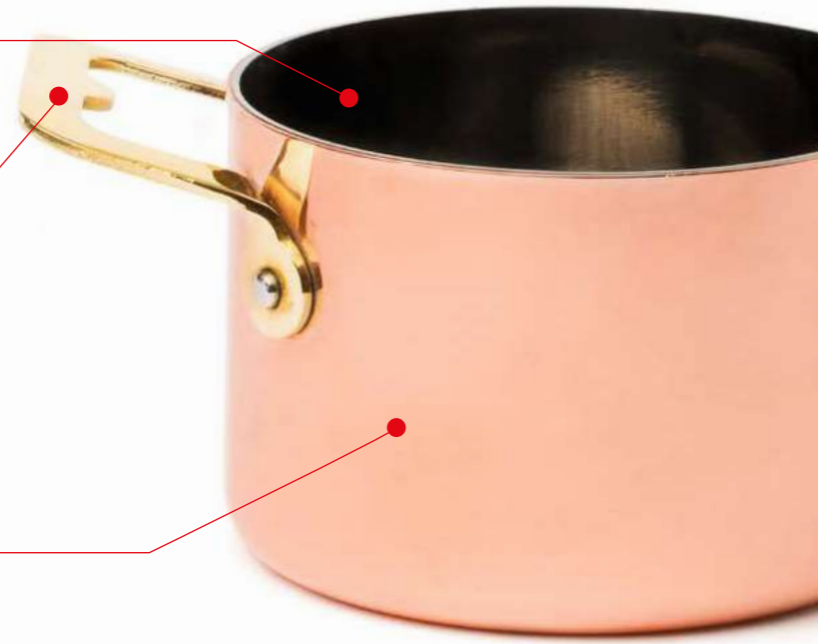

Mini sartén doble pared

Mini fry pan dual body
Mini poêle double paroi
Mini padella doppia parete
Copper mini pfanne dualer körper



REF.	Ø(mm)	H(mm)	€	UE / MOQ
7493	120	35	65,66	1-6-48 / 1

Mini olla doble pared

Mini casserole dual body
Mini casserole double paroi
Mini pentola doppia parete
Mini kasserole dualer körper



REF.	Ø(mm)	H(mm)	€	UE / MOQ
7495	90	60	53,20	1-6-48 / 1

Mini cazo doble pared

Mini saucepan dual body
Mini casserole double paroi
Mini casseruola doppia parete
Mini sauteuse dualer körper



REF.	Ø(mm)	H(mm)	€	UE / MOQ
7491	70	50	32,45	1-6-48 / 1



PACKAGING
HANG TAG



Mini sartén inox

Mini fry pan inox
Mini poêle inox
Mini padella inox
Mini pfanne edelstah



REF.	Ø(mm)	H(mm)	€	UE / MOQ
7492	100	30	15,12	1-6-48 / 1

Mini cazo inox

Mini saucepan inox
Mini casserole inox
Mini casseruola inox
Mini sauteuse edelstahl



REF.	Ø(mm)	H(mm)	€	UE / MOQ
7490	70	50	11,49	1-6-48 / 1

Cubo snack

Snack bucket
Bol à aperitif
Vaschetta snack
Snack eimer



REF.	Ø(mm)	H(mm)	ml	€	UE / MOQ
7104	125	130	800	6,79	1-6-24 / 1
7103	85	90	320	4,62	1-6-24 / 1
7102	70	75	200	3,91	1-6-24 / 1

Mini cubo inox

Inox mini bin
Mini seau inox
Mini bidone inox
Mini behälter edelstahl



REF.	Ø(mm)	H(mm)	ml	€	UE / MOQ
7500	150	140	1500	18,36	1-6-48 / 1
7499	130	120	850	13,37	1-6-48 / 1
7498	90	90	350	6,91	1-6-48 / 1



Cesto cuadrado
Square basket
Panier à frites carré
Cestino quadrato da frittura
Quadratischer korb



REF.	COLOR	W(mm)	L(mm)	H(mm)	€	UE / MOQ
7482	silver	100	90	70	7,85	1-12-144 / 1
7483	gold	100	90	70	8,69	1-12-144 / 1
7484	black	100	90	70	9,86	1-12-144 / 1

Cesto cuadrado
Square basket
Panier à frites carré
Cestino quadrato da frittura
Quadratischer korb



REF.	W(mm)	L(mm)	H(mm)	€	UE / MOQ
7485	130	110	90	9,47	1-12-144 / 1

Mini freidora cuadrada
Mini square fryer
Mini friteuse
Mini friggitore
Quadratischer mini fittierkorb



REF.	W(mm)	L(mm)	H(mm)	€	UE / MOQ
7488	110	110	50	8,71	1-12-48 / 1

Cesto redondo
Round basket
Panier à frites rond
Cestino rotondo da frittura
Runder korb



REF.	Ø(mm)	H(mm)	€	UE / MOQ
7480	80	85	6,05	1-12-144 / 1
7481	90	125	7,56	1-12-144 / 1

Cono chips
Cone for chips
Cornet de frites
Cono per patatine fritte
Kegel für pommies



REF.	Ø(mm)	H(mm)	€	UE / MOQ
7487	110	230	6,05	1-12-144 / 1

Cesto rectangular
Rectangular basket
Panier à frites rectangulaire
Cestino rettangolare per frittura
Rechteckiger korb



REF.	W(mm)	L(mm)	H(mm)	€	UE / MOQ
7486	210	100	40	10,53	1-6-72 / 1

Cesto con asas
Basket with handles
Panier à frites avec des poignées
Cestino da frittura maniglie
Korb mit griffen



REF.	W(mm)	L(mm)	H(mm)	€	UE / MOQ
7489	110	85	55	7,38	1-12-72 / 1



PACKAGING
HANG TAG

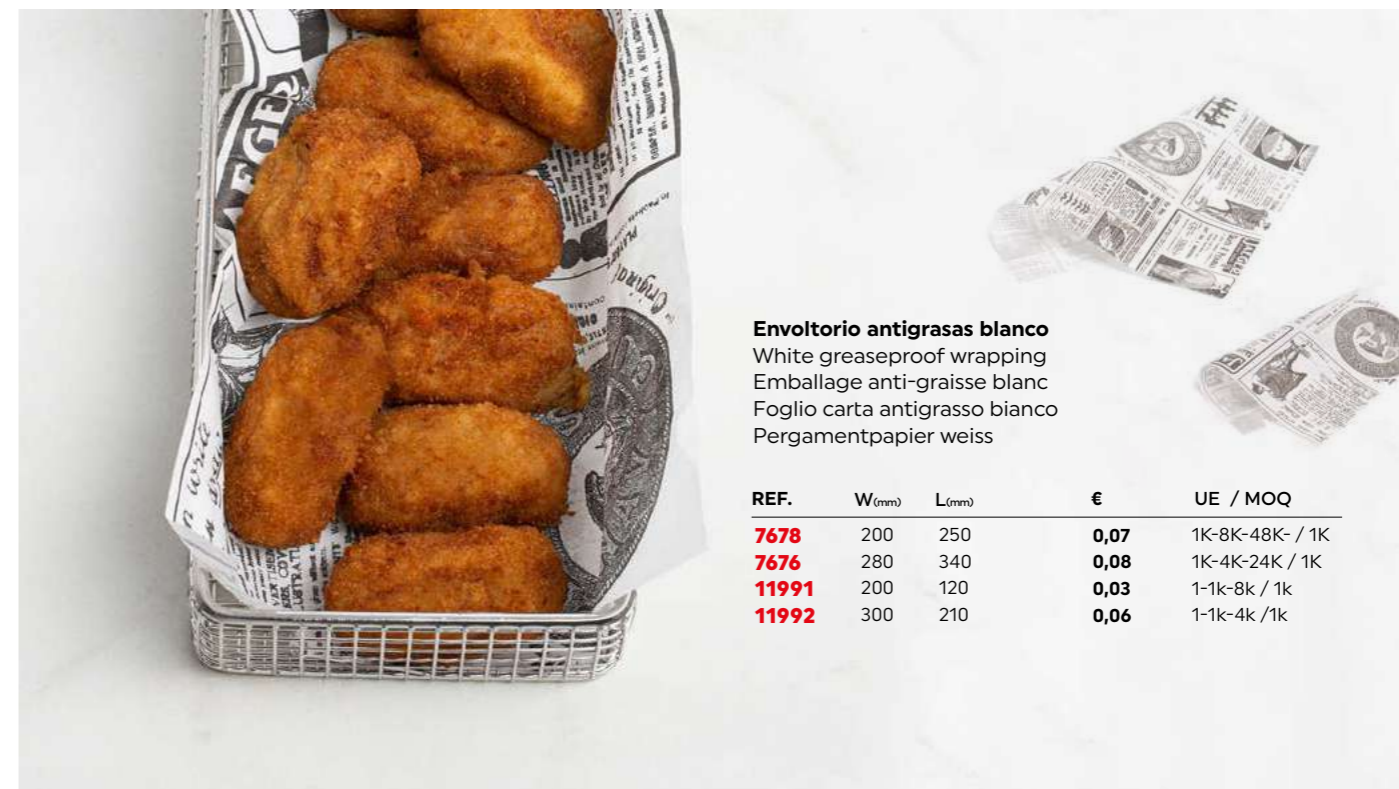

Envoltorio antigrasas blanco
White greaseproof wrapping
Emballage anti-graisse blanc
Foglio carta antigrasso bianco
Pergamentpapier weiss

REF.	W(mm)	L(mm)	€	UE / MOQ
7678	200	250	0,07	1K-8K-48K- / 1K
7676	280	340	0,08	1K-4K-24K / 1K
11991	200	120	0,03	1-1k-8k / 1k
11992	300	210	0,06	1-1k-4k / 1k

Envoltorio antigrasas natural
Natural greaseproof wrapping
Emballage anti-graisse naturel
Foglio carta antigrasso naturale
Pergamentpapier natur



REF.	W(mm)	L(mm)	€	UE / MOQ
7677	280	340	0,09	1K-4K-24K / 1K

Envoltorio antigrasas times natural
Times natural greaseproof wrapping
Emballage anti-graisse times naturel
Foglio carta antigrasso times naturale
Pergamentpapier weiss times naturel



REF.	W(mm)	L(mm)	€	UE / MOQ
8809	280	340	0,08	1K-4K-24K / 1K

Envoltorio antigrasas negro
Black greaseproof wrapping
Emballage anti-graisse noir
Foglio carta antigrasso nero
Pergamentpapier schwarz



REF.	W(mm)	L(mm)	€	UE / MOQ
7674	280	340	0,08	1K-4K-24K / 1K

Envoltorio antigrasas rojo
Red greaseproof wrapping
Emballage anti-graisse rouge
Foglio carta antigrasso rosso
Pergamentpapier rot



REF.	W(mm)	L(mm)	€	UE / MOQ
7675	280	340	0,08	1K-4K-24K / 1K



Mini caldero 3 patas

Mini cooking pot 3 feet
Mini cocotte en fonte 3 pieds
Mini casseruola di ghisa 3 piedi
Gusseisen mini kasserole m. 3 füßen

Compatible con:
7789



REF.	Ø(mm)	H(mm)	ml	€	UE / MOQ
7510	110	95	35	26,48	1-6-12 / 6



Mini sartén cuadrada

Mini square pan
Mini poêle carrée en fonte
Mini padella quadrata di ghisa
Gusseisen quadratische mini pfanne

Compatible con:
7791



REF.	Ø(mm)	H(mm)	ml	€	UE / MOQ
7503	140	140	30	11,44	1-6-12 / 1



Mini olla oval

Mini oval casserole
Mini cocotte ovale en fonte
Mini casseruola ovale di ghisa
Gusseisen ovale mini kasserole

Compatible con:
7790



REF.	W(mm)	L(mm)	H(mm)	ml	€	UE / MOQ
7506	95	125	55	270	16,29	1-6-12 / 6



Mini sartén redonda 2 asas

Mini round pan 2 handles
Mini poêle ronde en fonte 2 poignets
Mini padella rotonda di ghisa 2 manici
Gusseisen runde mini pfanne m. 2 griffen

Compatible con:
7789



REF.	Ø(mm)	H(mm)	€	UE / MOQ
7508	122	30	8,81	1-6-24 / 1



Mini sartén

Mini pan
Mini poêle en fonte
Mini padella di ghisa
Gusseisen mini pfanne

Compatible con:
7789



REF.	Ø(mm)	H(mm)	€	UE / MOQ
7502	90	25	6,05	1-6-24 / 1



Mini sartén

Mini pan
Mini poêle en fonte
Mini padella di ghisa
Gusseisen mini pfanne

Compatible con:
7789



REF.	Ø(mm)	H(mm)	€	UE / MOQ
7501	130	15	8,55	1-6-24 / 1



Mini sartén oval 2 asas

Mini oval pan 2 handles
Mini poêle ovale en fonte 2 poignets
Mini padella ovale di ghisa 2 manici
Gusseisen ovale mini pfanne m. 2 griffen

Compatible con:
7790



REF.	W(mm)	L(mm)	H(mm)	€	UE / MOQ
7507	180	126	35	11,83	1-6-24 / 6



Mini sartén redonda 2 asas

Mini round pan 2 handle
Mini poêle ronde en fonte 2 poignets
Mini padella rotonda di ghisa 2 manici
Gusseisen runde mini pfanne m. 2 griffen

Compatible con:
7789



REF.	Ø(mm)	H(mm)	€	UE / MOQ
7509	145	30	10,13	1-6-24 / 1



1 Lavar antes del primer uso.
Wash before first use.

2

Después de cada uso, dejar enfriar y lavar a mano.
After each use, leave to cool and wash by hand.



3

Untar con aceite para una mejor conservación.
Spread with oil for better preservation.

* **Nuestras piezas de hierro fundido no son antideslizantes.**
Our cast iron griddles are not non-stick items.



Mini olla

Mini casserole
Mini cocotte en fonte
Mini casseruola di ghisa
Gusseisen mini kasserole

Compatible con:
7789



REF.	Ø(mm)	H(mm)	ml	€	UE / MOQ
7504	140	110	60	24,20	1-6-12 / 1



Mini olla

Mini casserole
Mini cocotte en fonte
Mini casseruola di ghisa
Gusseisen mini kasserole

Compatible con:
7789



REF.	Ø(mm)	H(mm)	ml	€	UE / MOQ
7505	110	60	35	16,29	1-6-24 / 6



Soporte madera
Wooden board
Support en bois
Table di legno
Holzplatte



REF.	ESPOSOR	W(mm)	L(mm)	€	UE / MOQ
7789	ROUND	150	150	7,88	1-6-12 / 1
7790	OVAL	200	140	8,69	1-6-12 / 1
7791	SQUARE	160	160	8,02	1-6-12 / 1



PACKAGING
BELT



Cuenco rectangular
Rectangular pie dish
Bol rectangulaire
Ciotola rettangolare
Eisenschälchen rechteckig

REF.	W(mm)	L(mm)	H(mm)	€	UE / MOQ
7517	145	200	40	7,48	1-12-48 / 1
7516	130	180	35	6,26	1-12-96 / 1
7515	120	160	30	5,78	1-12-96 / 1



Cuenco rectangular
Rectangular pie dish
Bol rectangulaire
Ciotola rettangolare
Eisenschälchen rechteckig

REF.	W(mm)	L(mm)	H(mm)	€	UE / MOQ
7520	145	200	40	7,48	1-12-48 / 1
7519	130	180	35	6,26	1-12-96 / 1
7518	120	160	30	5,78	1-12-96 / 1



Plato llano
Flat plate
Assiette plate
Piatto piano
Flacher teller

REF.	SIZE	Ø(mm)	H(mm)	€	UE / MOQ
10909	PLATO LLANO	260	20	10,21	0-12-48 / 1
10910	PLATO HONDO	220	35	8,61	0-12-48 / 1
10908	PLATO POSTRE	200	15	8,03	0-12-96 / 1



Plato hondo
Deep plate
Assiette plate
Piatto fondo
Tiefer teller



Plato postre
Dessert plate
Assiette dessert
Piatto dessert
Dessertteller

REF.	SIZE	Ø(mm)	H(mm)	€	UE / MOQ
10909	PLATO LLANO	260	20	10,21	0-12-48 / 1
10910	PLATO HONDO	220	35	8,61	0-12-48 / 1
10908	PLATO POSTRE	200	15	8,03	0-12-96 / 1



Cuchara de té
Tea spoon
Cuillère à thé
Cucchiaio da tè
Teelöffel

REF.	SIZE	L(mm)	€	UE / MOQ
7511	CUCHARA DE TÉ	150	1,80	1-12-120 / 1
7512	CUCHARA DE MESA	200	1,93	1-12-120 / 1
7513	CUCHARA DE SERVIR	300	3,73	1-10-50 / 1

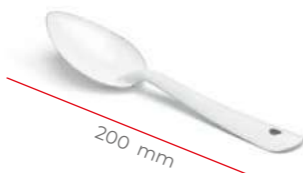

Cuchara de mesa
Table spoon
Cuillère de table
Cucchiaio da tavola
Tafelöffel

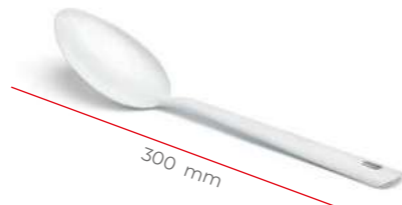

Cuchara de servir
Server spoon
Cuillère servir
Cucchiaio da portata
Servierlöffel

REF.	SIZE	L(mm)	€	UE / MOQ
7511	CUCHARA DE TÉ	150	1,80	1-12-120 / 1
7512	CUCHARA DE MESA	200	1,93	1-12-120 / 1
7513	CUCHARA DE SERVIR	300	3,73	1-10-50 / 1

Vaso para dipear
Dip cup
Mini coupe pour tremper
Bicchiere per sugo
Eisen dipschale



REF.	Ø(mm)	H(mm)	ml	€	UE / MOQ
7530	70	30	100	4,46	1-12-96 / 1
7529	60	40	90	4,24	1-12-96 / 1

Vaso alto
Taller tumbler
Coupe hauteur
Bicchiere
Emailliertes



REF.	Ø(mm)	H(mm)	ml	€	UE / MOQ
7528	80	120	400	9,02	1-12-48 / 1
7527	80	90	290	6,42	1-12-96 / 1

Cazuela 2 asas
Casserole 2 handle
Casserole 2 poignées
Casseruola 2 manici
Kasserole mit griff



REF.	Ø(mm)	H(mm)	ml	€	UE / MOQ
7525	100	50	310	7,56	1-12-96 / 1

Cazuela 2 asas marrón
Brown casserole 2 handle
Casserole émaillé 2 poignées brown
Casseruola ferro smaltato 2 manici brown
Emaillierte kasserole mit griff brown



REF.	Ø(mm)	H(mm)	ml	€	UE / MOQ
7524	100	50	310	8,53	1-12-96 / 1

Lechera
Creamer
Laitière
Bidone del latte
Eisenkännchen



REF.	Ø(mm)	H(mm)	ml	€	UE / MOQ
7514	70	65	190	8,31	1-12-96 / 1

Taza
Mug
Tasse
Tazza
Eisenbecher



REF.	Ø(mm)	H(mm)	ml	€	UE / MOQ
7522	70	70	250	6,37	1-12-96 / 1
7521	60	45	100	4,56	1-12-96 / 1

Bol
Bowl
Bol
Ciotola
Eisenschale



REF.	Ø(mm)	H(mm)	ml	€	UE / MOQ
7526	140	60	510	6,95	1-12-48 / 1

Mini cazuela 2 asas marrón
Brown mini casserole 2 handle
Mini casserole émaillé 2 poignées brown
Mini casseruola ferro smaltato 2 manici brown
Emaillierte mini kasserole mit griff brown



REF.	Ø(mm)	H(mm)	ml	€	UE / MOQ
7523	100	30	125	7,00	1-12-48 / 1



DIM-SUM

Vaporera bambú
Bamboo Steamer
Vapociseur Bambou
Vaporiera Bamboo
Bambusdämpfer



REF.	Ø(mm)	H(mm)	PISOS	RACIONES	€	UE / MOQ
7830	100	70	1	TAPA	8,64	1-4-72 / 4
7831	130	85	1	RACIÓN	9,83	1-4-36 / 4
7832	150	85	1	INDIVIDUAL	11,13	1-4-36 / 4
11966	200	135	2	2 RACIONES	21,02	1-0-8 / 8
11967	250	160	2	3-4 RACIONES	25,79	1-0-6 / 6
11968	300	165	2	5-6 RACIONES	29,61	1-0-3 / 3

Papel Perforado Vaporera Bamboo

Perforated Bamboo Steamer Paper
Papier Perforé Vapociseur Bambou
Foglio Di Carta In Bambu' Perforato Per Vaporiera Perforiertes Papier Für Bambusdämpfer

REF.	Ø(mm)	€	UE / MOQ
11969	130	0,04	1-250-2000/ 250
11970	170	0,06	1-250-2000/ 250
11971	280	0,12	1-250-2000/ 250



Madera de haya de alta calidad.

High quality beech wood.

Acabados con aceites naturales que protegen y alargan la durabilidad de las piezas.

Finishes with natural oils that protect and prolong the pieces durability.

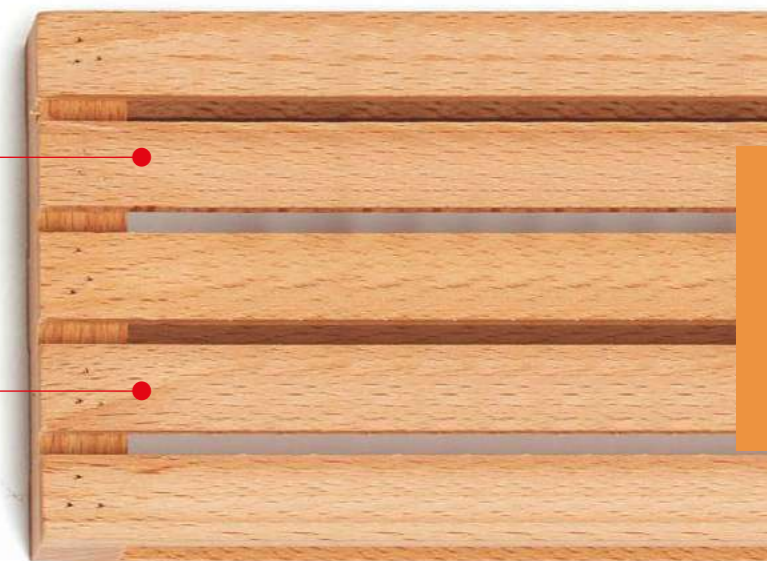

Mini palé

Mini pallet
Mini palette
Mini bancale
Mini palette



REF.	W(mm)	L(mm)	H(mm)	€	UE / MOQ
7548	120	200	35	6,35	1-3-36 / 1
11965	300	180	35	12,90	1-0-20 / 20



Mini caja rectangular

Mini rectangular wooden box
Mini cagette rectangulaire
Mini cassetta legno rettangolare
Rechteckige mini holzbox

REF.	W(mm)	L(mm)	H(mm)	€	UE / MOQ
7542	150	100	58	7,51	1-0-32 / 1
7543	230	130	70	9,67	1-0-12 / 1
7546	240	160	70	12,09	1-0-12 / 1



Mini caja cuadrada

Mini square box
Mini cagette carrée en bois
Mini cassetta legno quadrata
Quadratische mini holzbox

REF.	W(mm)	L(mm)	H(mm)	€	UE / MOQ
7544	170	170	80	9,07	1-0-12 / 1
7545	210	210	70	11,49	1-0-12 / 1



Mini caja

Mini wooden box
Mini cagette en bois
Mini cassetta legno
Mini holzbox

REF.	W(mm)	L(mm)	H(mm)	€	UE / MOQ
7539	125	80	90	11,19	1-0-24 / 1
7540	130	170	90	13,61	1-0-12 / 1

ZINC

Cubo galvanizado

Zinc ice bucket
Seau en acier galvanisé
Cubetto galvanizzato
Zinn-eiskühler



Fondo sellado con silicona que permite contener líquido con total seguridad.

Silicone sealed bottom allows contain liquids safely.

REF.	SIZE	W(mm)	L(mm)	H(mm)	ml	€	UE / MOQ
7533	XL	350	510	230	24000	24,19	1-0-6 / 1
7534	M	300	390	187	14000	15,12	1-0-8 / 1

Cubitera tipo ensaladera

Ice cube bowl
Vasque
Coppa con base
Champagner kühler becken



REF.	Ø(mm)	H(mm)	ml	€	UE / MOQ
2727	345	230	10.000	28,41	1-0-4 / 1

Cubo champagne 2 bot.

2 bottles champagne bucket
Seau champagne 2 bouteilles
Rinfrescatore champagne 2b
Champagner kühler



REF.	Ø(mm)	H(mm)	ml	€	UE / MOQ
5513	240	220	6.500	59,00	1-0-4 / 1

INOX STAINLESS STEEL 201

COTTON

Enfriador de botella inox

Bottle cooler inox
Glacette inox
Refrigeratore inox
Edelstahlkühle



REF.	COLOR	Ø(mm)	L(mm)	ml	€	UE / MOQ
2765	inox	120	180	1.250	19,38	1-0-6 / 1

INOX STAINLESS STEEL 201

Soporte cubo mesa

Wine bucket stand support
Support de table pour seau
Supporto secchio tavola
Halter für tischeimer



Compatible con:
4967 (p.413)

REF.	H(mm)	€	UE / MOQ
7112	200	17,68	1-0-5 / 5

Cubo hielo Lux

Bucket lux
Seau à glace lux
Secchiello ghiaccio lux
Eiseimer lux



REF.	Ø(mm)	H(mm)	ml	€	UE / MOQ
3096	120	135	1.000	9,21	1-0-20 / 1

Cubo champagne

Champagne bucket
Seau champagne
Rinfrescatore champagne
Champagner kühler



REF.	Ø(mm)	H(mm)	ml	€	UE / MOQ
4967	200	210	3.500	17,19	1-0-6 / 1

INOX STAINLESS STEEL 201

Pie cubo champagnera 2 botellas

Champagne bucket stand 2 bottles
Pied porte-seau champagne 2 bouteilles
Colona portasecchiolo 2b
Ständer f. 2 champagnerkühler



REF.	Ø(mm)	H(mm)	€	UE / MOQ
5653	220	630	87,15	1-0-4 / 1

INOX STAINLESS STEEL 201

Pie cubo champagnera 1 botella

Champagne bucket stand 1 bottle
Pied porte-seau champagne 1 b.
Colona portasecchiolo 1b.
Ständer f. 1 champagnerkühler



REF.	H(mm)	€	UE / MOQ
2786	720	23,14	1-0-0 / 1

Cubo hielo inox

Stainless steel ice bucket
Seau à glace inox
Secchiello ghiaccio
Edelstahl eiseimer



REF.	Ø(mm)	H(mm)	ml	€	UE / MOQ
3093	110	130	800	12,94	1-0-20 / 1

Champagnera inox

Stainless steel champagne bucket
Seau à champagne
Secchiello champagne
Champagne eimer



REF.	Ø(mm)	H(mm)	ml	€	UE / MOQ
3095	175	195	3.500	25,10	1-0-6 / 1

Cubo hielo isotérmico

Double wall plain
Seau à glace isotherme
Secchiello ghiaccio isolato
Isoliert eiseimer



REF.	Ø(mm)	H(mm)	ml	€	UE / MOQ
3097	120	135	1.000	21,65	1-0-20 / 1

Cubo hielo

Ice bucket
Seau à glaçons
Secchiello ghiaccio
Eisbehälter



REF.	Ø(mm)	H(mm)	ml	€	UE / MOQ
4968	140	130	1.000	5,86	1-0-20 / 1

Compatible con: **4967 - 5513 - 3095**

Compatible con: **4967 - 3095**



Panera redonda kraft lavable 17
Washable round kraft breadbasket 17
Corbeille à pain ronde kraft lavable 17
Portopane rotondo kraft lavabile 17
Baschbarkraft, runder brotkorb 17



REF.	Ø(mm)	H(mm)	€	UE / MOQ
7455	170	120	8,88	1-5-50 / 5

Panera oval kraft lavable
Washable oval kraft breadbasket
Corbeille à pain ovale kraft lavable
Portopane ovale kraft lavabile
Baschbarkraft, ovaler brotkorb



REF.	W(mm)	L(mm)	H(mm)	€	UE / MOQ
7457	250	180	130	13,19	1-5-50 / 5

COMPATIBLE CON: **7459**

3
CAPAS
LAYERS + RIGIDEZ
RIGIDITY

COTTON

Panera grissini
Breadsticks holder
Corbeille à grissini
Cestino porta grissini
Brotkorb für grissini

REF.	COLOR	Ø(mm)	H(mm)	€	UE / MOQ
7779	GRIS	100	220	11,76	1-5-50 / 5
7778	BEIGE	100	220	10,88	1-5-50 / 5

Panera redonda kraft lavable 20
Washable round kraft breadbasket 20
Corbeille à pain ronde kraft lavable 20
Portopane rotondo kraft lavabile 20
Baschbarkraft, runder brotkorb 20



REF.	Ø(mm)	H(mm)	€	UE / MOQ
7456	200	120	10,76	1-5-50 / 5

COMPATIBLE CON: **7459**

Material kraft.

Kraft Material



Panera cuadrada 100% algodón
Square breadbasket 100% cotton
Corbeille à pain carrée
Portopane quadrato
Quadratischer brotkorb

REF.	COLOR	W(mm)	L(mm)	H(mm)	€	UE / MOQ
7598	BEIGE	120	120	140	8,62	1-5-50 / 5
7599	GRIS	120	120	140	8,92	1-5-50 / 5

COTTON



Panera redonda gris 17
Round grey Breadbasket 17
Corbeille à pain ronde grise 17
Portopane rotondo grigio 17
Grauer, runder brotkorb 17



REF.	Ø(mm)	H(mm)	€	UE / MOQ
7451	170	100	9,88	1-5-50 / 5

Panera redonda gris 20
Round grey Breadbasket 20
Corbeille à pain ronde grise 20
Portopane rotondo grigio 20
Grauer, runder brotkorb 20



REF.	Ø(mm)	H(mm)	€	UE / MOQ
7452	200	120	12,05	1-5-50 / 5

COMPATIBLE CON: **7459** (p.399)



Calentador con cerámica térmica
Warmer with ceramic beans
Corbeille à pain thermique
Portopane termico
Thermo-brotkorb

REF.	Ø(mm)	H(mm)	€	UE / MOQ
7458	200	130	15,16	1-5-50 / 5

COTTON



MANTIENE
EL CALOR
KEEPS WARM

Piezas de cerámica sin esmalte que mantienen el calor durante 45 minutos con sólo 30 segundos de microondas.

Glaze-free ceramic beans keep warm for 45 minutes with only 30 seconds of microwave.



Accesorio cerámica térmica
Ceramic beans warmer bag
Base thermique
Base termica
Thermo-basis



REF.	Ø(mm)	€	UE / MOQ
7459	190	10,57	1-5-50 / 5

COMPATIBLE CON / COMPATIBLE WITH: (p.397)



Panera oval gris
Oval grey breadbasket
Cobeille à pain ovale grise
Portopane ovale grigio
Grauer, ovaler brotkorb



REF.	W(mm)	L(mm)	H(mm)	€	UE / MOQ
7453	200	150	100	11,46	1-5-50 / 5
7454	250	180	120	12,35	1-5-50 / 5

COMPATIBLE CON: **7459** (p.399)

Capas exteriores:
100% algodón
Capa interior:
35% algodón
65% poliester

Outer layers:
100% cotton
Inner layer:
35% cotton
65% polyester

+RIGIDEZ /RIGIDITY



INOX
STAINLESS
STEEL
201

Panera inox
Bread basket
Corbeille à pain
Porta pane
Brotkorb

REF.	Ø(mm)	H(mm)	€	UE / MOQ
4952	200	95	6,14	1-4-48 / 1

GLASS



Caja salsa
Table caddies
Cagette sauces
Cassetta per salse
Tisch organizer



REF.	W(mm)	L(mm)	H(mm)	€	UE / MOQ
7840	200	150	180	26,64	1-0-12 / 1

GLASS

PARIS

Vinagrera PARIS 2 piezas
2 pieces cruet set PARIS
Ménagère 2 pièces PARIS
Oliera 2pc. mod. PARIS
2-Teilige menage PARIS



REF.	ml	€	UE / MOQ
3698	150	8,12	1-0-24 / 1

PARIS

Juego sal pimienta y mostaza
Salt, pepper and mustard set
Ménagère sel, poivre et moutarde
Sale pepe e senape mod.
Salz/pfeffer/senf-set



REF.	ml	€	UE / MOQ
3165	150	7,37	1-0-24 / 1

PARIS

Bandeja 12 rec. vinagrera PARIS
Pack 12 oil/vinegar bottle PARIS
Pack 12 bouteilles recharge PARIS
Pack 12 rec. oliera PARIS
12 teilige PARIS



REF.	ml	€	UE / MOQ
3783	150	26,70 / pack 12	1-0-8 / 1

CUADRADA

Set 4 pzas. vinagrera cuadrada
4 pieces square cruet set
Ménagère, 4 pièces
Servizio oliera, 4 pezzi
Menage, 4-teilig



REF.	ml	€	UE / MOQ
8392	250	9,52	1-0-12 / 1

PARIS

Vinagrera PARIS 4 piezas
4 pieces cruet set PARIS
Ménagère 4 pièces PARIS
Oliera 4pc. mod. PARIS
4-Teilige menage PARIS



REF.	ml	€	UE / MOQ
3697	150	9,96	1-0-24 / 1

PARIS

Juego sal y pimienta PARIS
Salt & pepper set PARIS
Ménagère sel et poivre PARIS
Sale e pepe mod. PARIS
Salz/pfeffer-set PARIS



REF.	H(mm)	€	UE / MOQ
3699	220	4,84	1-12-72 / 1

PARIS

Bandeja 12 saleros Paris
Salt/pepper shakers PARIS
Salières PARIS
Sale PARIS
Ersalzflaschen PARIS



REF.	H(mm)	€	UE / MOQ
3905	90	14,71 / pack 12	1-12-300 / 1

CUADRADA

Set 2 pzas. vinagrera cuadrada
2 pieces square cruet set
Ménagère, 2 pièces
Servizio oliera, 2 pezzi
Menage, 2-teilig



REF.	ml	€	UE / MOQ
8393	250	7,37	1-0-24 / 1

BOROSILICATE

+ RESISTENCIA
RESISTANCE

ANTIGOTEO

Set 2 pzas. vinagrera antigoteo
Non drip 2 pieces cruet set
Ménagère, 2 pièces
Servizio oliera, 2 pezzi
Menage, 2-teilig



REF.	ml	€	UE / MOQ
8387	260	22,63	1-0-12 / 11

BOROSILICATE

+ RESISTENCIA
RESISTANCE

ANTIGOTEO

Botella antigoteo
Non drip bottle
Bouteille anti-goutte
Bottiglia antigoccia
Anti-tropf-flasche



REF.	ml	€	UE / MOQ
8388	500	12,15	1-0-24 / 1
8389	250	10,00	1-0-36 / 1

Boquilla fina para verter el líquido con precisión.

Fine spout for precision pouring.

Fácil de rellenar gracias a su boquilla extraíble.

Removable spout makes for easy refilling.

Collar que recoge las gotas que puedan quedar en la boquilla y evita ensuciar la mesa.

Collar that collects any liquid left in the spout and keeps the table clean..

Cuello de vidrio glaseado que fija la boquilla.

Frosted glass collar that keeps the spout in place.

BOROSILICATE



PACKAGING BOX

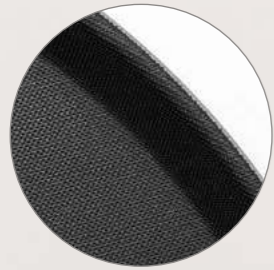

Tratamiento antideslizante:
Textura engomada que evita que los objetos se deslicen por la superficie con el movimiento.

Anti-slip:
Rubbery surface texture that keeps pieces in place while you carry them.



PP
POLYPROPYLENE



Bandeja antideslizante
Non slip serving tray
Plateau de service antidérapant
Vassoio antiscivolo
Rutschfestes serviertablett

REF.	Ø(mm)	€	UE / MOQ
8413	360	6,46	1-0-12 / 1
8414	400	8,60	1-0-12 / 1

FIBER-GLASS



Bandeja FIBERGLASS antideslizante
FB round non slip serving tray
Plateau de service rond antidérapant FB
Piatto da portata rotondo antiscivolo FB
Rutschfreies rundes FB serviertablett

REF.	Ø(mm)	€	UE / MOQ
8420	360	10,96	1-0-12 / 1
8421	400	14,16	1-0-12 / 1

FIBER-GLASS



Bandeja FIBERGLASS antideslizante rectangular
FB rectangle non slip serving tray
Plateau de service rectangle antidérapant FB
Piatto da portata rettangolare antiscivolo FB
Rutschfreies rechteck FB serviertablett

REF.	W(mm)	L(mm)	€	UE / MOQ
8415	360	460	11,60	1-0-12 / 1
8416	380	510	16,24	1-0-12 / 1
8417	400	560	23,20	1-0-12 / 1

INOX
STAINLESS
STEEL
201



Bandeja camarero
Serving tray
Plateau barman
Vassoio bar
Serviertablett

REF.	Ø(mm)	€	UE / MOQ
4950	400	15,79	1-0-12 / 1

FIBER-GLASS



Bandeja FIBERGLASS antideslizante oval
FB oval non slip serving tray
Plateau de service ovale antidérapant FB
Piatto da portata ovale antiscivolo FB
Rutschfreies oval FB serviertablett

REF.	W(mm)	L(mm)	€	UE / MOQ
8418	560	680	35,43	1-0-6 / 6

BEECH
WOOD



Soporte bandeja
Tray support
Support de plateau
Supporto vassoio
Unterstützung serviertablett

REF.	W(mm)	L(mm)	H(mm)	€	UE / MOQ
8419	440	433	835	103,18	1-0-1 / 1



Bandeja ovalada
Oval heavy try
Plateau ovale
Vassoio ovale
Tablett oval

REF.	W(mm)	H(mm)	€	UE / MOQ
7093	170	250	4,95	1-0-24 / 1
7094	210	300	6,42	1-0-24 / 1
7095	235	350	7,63	1-0-24 / 1
7096	270	400	10,00	1-0-24 / 1
7097	295	450	14,39	1-0-24 / 1
7098	340	500	16,12	1-0-24 / 1
7099	415	600	23,57	1-0-20 / 1



Bandeja pescado
Fish tray
Plateau poisson
Piatto pesce
Fischtablett

REF.	W(mm)	H(mm)	€	UE / MOQ
7100	250	600	14,85	1-0-20 / 1
7101	258	700	29,64	1-0-20 / 1

INOX STAINLESS STEEL 201



Coctelera delux
Cocktail shaker delux
Shaker delux
Shaker per cocktail delux
Cocktailshaker delux

REF.	H(mm)	ml	€	UE / MOQ
3024	190	750	7,38	1-0-24 / 1
3023	165	500	5,55	1-0-24 / 1



Cuchara coctel
Cocktail spoon
Cuillère cocktail
Cucchiaio cocktail
Cocktailöffel

REF.	L(mm)	€	UE / MOQ
3151	290	7,39	1-12-120 / 1

NEW

Sacacorchos
Waiter's corkscrew
Tire-bouchon de serveur
Cavatappi cameriere
Kellnermesser



REF.	L(mm)	W(mm)	H(mm)	€	UE / MOQ
12174	122	20	13	2,69	1-20-240 / 1

Cenicero agua
Water ashtray
Cendrier eau
Portaceneri
Wasser-aschenbecher



REF.	Ø(mm)	H(mm)	€	UE / MOQ
4951	95	38	4,93	1-0-96 / 1

Vaso medidor
Measuring cup
Verre mesureur
Misurino cocktail
Messglas



REF.	H(mm)	ml	€	UE / MOQ
3021	100	30 / 60	1,84	1-24-96 / 1



Cuchara sangría
Sangria spoon
Cuillère sangria
Cucchiaio sangria
Sangriöffel

REF.	L(mm)	€	UE / MOQ
2728	265	1,46	1-12-120 / 1

Jarra agua
Water jug
Carafe d'eau
Caraffa d'acqua
Wasserkaraffe



REF.	Ø(mm)	H(mm)	ml	€	UE / MOQ
3030	100	145	1.250	19,10	1-0-6 / 1

Servilletero
Napkin dispenser
Distributeur serviettes
Portasalvietta
Serviettenhalter



REF.	W(mm)	H(mm)	€	UE / MOQ
5039	130	100	7,10	1-0-24 / 1

INOX STAINLESS STEEL 201

THERMO PLASTIC RUBBER



Alfombra para barra estrecha
Bar mats
Dessus-de-table pour comptoir de bar
Tappetino bar
Gläserabstellmatte

REF.	W(mm)	L(mm)	€	UE / MOQ
8427	85	600	14,29	1-0-16 / 1

ABS PLASTIC

FOOD CONTACT



Recipientes coctelería
Containers for cocktail shaker
Récipients pour cocktails
Portacondimenti
Bar-beilagenbehälter

REF.	W(mm)	L(mm)	H(mm)	€	UE / MOQ
8433	156	492	90	38,64	1-0-12 / 1

PP POLYPROPYLENE



Cesta cubiertos gris
Cutlery dispenser
Récipient à couverts
Portaposate
Besteckbehälter

REF.	W(mm)	L(mm)	H(mm)	€	UE / MOQ
8429	290	525	98	12,08	1-0-12 / 1

THERMO PLASTIC RUBBER



Alfombra para barra ancha
Bar mats
Dessus-de-table pour comptoir de bar
Tappetino bar
Gläserabstellmatte

REF.	W(mm)	L(mm)	€	UE / MOQ
8428	300	450	25,72	1-0-15 / 1



Tapón dosificador
Flow pourers
Bec verseur
Tappo versatore dosatore
Dosierausgiesser

REF.	W(mm)	L(mm)	€	UE / MOQ
8426	40	110	18,34 / pack 6	1-10-100 / 6



Tabla Corte Negra
Black Cutting Board
Planche à découper Noir
Tagliere Nero
Schwarz Schneidebrett

REF.	WxL(mm)	ESPOSOR	TACOS	€	UE / MOQ
11760	30x20	2	4	14,00	1-0-8 / 1
11759	40x30	2	4	26,10	1-0-6 / 1

OLLAS Y SARTENES

COCCIÓN

COOKING

- 308 BATERÍAS
- 316 SARTENES
- 320 RISOLÍ
- 322 PAELLERAS

CORTE

CUTTING

- 330 130 COLLETION
- 332 MESTRE MAURICI
- 336 ZEN
- 340 MARBLE
- 344 IBÉRICA - GRAFIT
- 348 PUNTILLAS
- 350 TABLAS DE CORTE
- 354 ACCESORIOS CORTE
- 358 MANTENIMIENTO Y CUIDADO
- 360 RALLADORES Y ACCESORIOS





Baterías profesionales

Cubriendo las diversas necesidades de la cocina profesional y dando respuesta a las mayores exigencias de cada uso. En Comas, nuestras ollas y sartenes han sido diseñadas para resistir los servicios más exigentes. Cada una de nuestras ollas y sartenes cumple con los criterios de los expertos que trabajan con su pasión y compromiso en los fogones, para lograr resultados extraordinarios en sus platos.

Professional cookware

It covers the diverse needs of the professional kitchen, responding to the greatest demands with each use. At Comas, our pots and pans have been designed to withstand the most demanding service. Each of our pots and pans are designed to meet the criteria of the expert chefs who are passionate about achieving extraordinary results in their dishes.



NEW

7 diámetros disponibles en ollas:
de 20 hasta 45 cm.

7 diameters available for pots: from
20 to 45 cm.

Asas de acero inoxidable unidas por múltiples puntos de soldadura estratégicamente distribuidos. Garantiza una sujeción robusta y duradera.

Stainless steel handles joined by multiple strategically distributed weld points. Guarantees a robust and durable hold.



DIFUSOR
SISTEMA SANDWICH
ENCAPSULADO

Capa intermedia
ALUMINIO.

Excelente conductividad térmica
y distribución uniforme del calor.

Core Aluminum layer.
Delivers excellent thermal
conductivity and even heat
distribution.

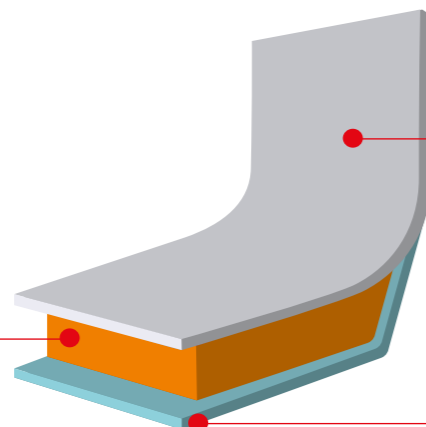

Interior
INOX 18/10 (AISI 304)

Máxima seguridad alimentaria, fácil limpieza e
higiene garantizada.

Interior S.S. 18/10 (AISI 304)
Ensures food safety, easy cleaning, and maxi-
mum hygiene.

Exterior
INOX 18/0 (AISI 430)

Alta durabilidad y compatibilidad con cocinas
de inducción.

Exterior S.S. (AISI 430)
Exceptional durability and induction compati-
bility.



Interior liso libre de remaches que pue-
dan acumular residuos o dificultar la
higiene.

Smooth interior free of rivets that could
accumulate debris or hinder hygiene.

Diámetro y material grabado en la ple-
tina de la asa en cada pieza.

Diameter and material engraved on the
handle plate of each piece.



Base grabada con información
técnica de material y tipo de fuen-
te de calor compatible.

Bottom engraved with technical
information on material and com-
patible heat source type.

Tapas adaptables a toda la gama:
de 20 a 45 cm de diámetro.

Lids adaptable to the entire range:
from 20 to 45 cm in diameter.

Mango fabricado en acero
inoxidable de forma tubular
para facilitar la sujeción de la
sartén.

Tubular stainless steel handle
for easy handling.



71,6L

25,7L

6,3L

Olla
Pot
Marmite
Pentola
Topf

REF.	Ø(mm)	H(mm)	Litros	€	UE / MOQ
12129	200	200	6,3	47,71	1-0-4 / 1
12130	240	240	10,9	60,88	1-0-4 / 1
12131	280	280	17,2	88,63	1-0-2 / 1
12132	320	320	25,7	124,00	1-0-2 / 1
12133	360	360	36,6	150,00	1-0-1 / 1
12134	400	400	50,3	180,00	1-0-1 / 1
12135	450	450	71,6	230,00	1-0-1 / 1



23,9L

10,6L

2,6L

Cacerola baja
Low casserole
Faitout
Casseruola bassa
Niedriger kochtopf

REF.	Ø(mm)	H(mm)	Litros	€	UE / MOQ
12136	200	80	2,6	39,00	1-0-8 / 1
12137	240	110	5	43,13	1-0-6 / 1
12138	280	130	8	60,00	1-0-6 / 1
12139	320	125	10,6	81,63	1-0-4 / 1
12140	360	140	14,3	97,63	1-0-2 / 1
12141	400	150	18,8	116,55	1-0-2 / 1
12142	450	150	23,9	138,50	1-0-2 / 1



44,5L

16,1L

4,4L

Cacerola alta
Deep casserole
Braising
Casseruola alta
Hoher kochtopf

REF.	Ø(mm)	H(mm)	Litros	€	UE / MOQ
12143	200	140	4,4	40,99	1-0-6 / 1
12144	240	160	7,2	48,75	1-0-4 / 1
12145	280	180	11,1	65,00	1-0-4 / 1
12146	320	200	16,1	83,00	1-0-2 / 1
12147	360	220	22,4	114,50	1-0-2 / 1
12148	400	250	31,4	145,65	1-0-2 / 1
12149	450	280	44,5	164,38	1-0-1 / 1



Cazo alto
High saucepan
Casserole haute
Pentola alta
Hoher Stieltopf

REF.	Ø(mm)	H(mm)	Litros	€	UE / MOQ
12161	160	120	2,5	31,25	1-0-12 / 1
12162	180	105	2,7	33,50	1-0-12 / 1
12163	200	140	4,4	37,50	1-0-6 / 1
12164	240	110	5	45,00	1-0-4 / 1



Cazo bajo
Low saucepan
Casserole basse
Pentola bassa
Niedriger Stieltopf

REF.	Ø(mm)	H(mm)	Litros	€	UE / MOQ
12157	160	95	2	28,75	1-0-12 / 1
12158	180	80	2	30,50	1-0-12 / 1
12159	200	105	3,3	32,00	1-0-6 / 1
12160	240	75	3,3	37,25	1-0-6 / 1

Tapa acero inoxidable
Stainless steel lid
Couvercle en acier inoxydable
Coperchio in acciaio inox
Deckel aus edelstahl



REF.	Ø(mm)	€	UE / MOQ
12150	200	9,13	1-6-12 / 1
12151	240	12,00	1-6-12 / 1
12152	280	14,62	1-6-12 / 1
12153	320	18,13	1-6-12 / 1
12154	360	21,25	1-0-6 / 1
12155	400	25,25	1-0-6 / 1
12156	450	31,00	1-0-6 / 1

Colador pasta acero inoxidable
Stainless Steel pasta colander
Cuit-pâtes en acier inoxydable
Colino per pasta in acciaio inox
Nudelsieb aus Edelstahl



REF.	H(mm)	W(mm)	COMPATIBLE Ø(mm)	€	UE / MOQ
12365	360	230	360	43,70	1-0-2 / 1
12366	400	260	400	53,13	1-0-2 / 1



Cazo Recto
Straight Ladle
Casserole Droite
Mestolo Dritto
Stieltopf

REF.	Ø(mm)	e(mm)	H(mm)	LITROS	€	UE / MOQ
11789	140	3	68	0,95	16,97	1-0-6 / 6
11790	160	3	76	1,4	19,26	1-0-6 / 6
11791	180	3	85	2	21,65	1-0-6 / 6
11792	200	3	98	2,88	24,68	1-0-6 / 6



Olla
Saucepan
Casserole
Pentola
Topf

REF.	Ø(mm)	e(mm)	H(mm)	LITROS	€	UE / MOQ
11780	200	3	140	4,18	28,17	1-0-4 / 4
11781	240	3	150	6,46	35,63	1-0-4 / 1
11782	280	3	170	9,98	43,69	1-0-4 / 1
11951	300	3	180	12,22	50,91	1-0-4 / 1
11952	320	3	185	14,32	55,14	1-0-4 / 1



Cacerola
Casserole
Fait-Tout
Casseruola
Stielkasserolle

REF.	Ø(mm)	e(mm)	H(mm)	LITROS	€	UE / MOQ
11787	240	3	100	4,25	29,91	1-0-4 / 4
11788	280	3	110	6,27	36,03	1-0-4 / 4
11953	300	3	120	8	42,70	1-0-4 / 1



Tapa Borosilicato
Borosilicate Lid
Couvercle Borosilicate
Coperchio In Vetro Borosilicato
Deckel Borosilikat Glasdeckel

REF.	Ø(mm)	€	UE / MOQ
11794	200	7,19	1-0-12 / 1
11795	240	7,76	1-0-12 / 1
11796	280	8,59	1-0-12 / 1
11954	300	9,15	1-0-12 / 1
11955	320	9,52	1-0-12 / 1



Sartén aluminio antiadherente alta mango inox
Deep frypan, non stick coating
Poêle avec revêtement anti-adhésif
Padella inox antiaderente
Bratpfanne mit antihafthbes

REF.	Ø(mm)	e(mm)	H(mm)	€	UE / MOQ
10897	240	3	70	24,13	1-0-6 / 1
10898	280	3	70	29,11	1-0-6 / 1
10899	320	3	80	34,88	1-0-6 / 1
11599	360	3	80	46,43	1-0-4 / 1 *
11601	400	3	90	53,67	1-0-4 / 1 *



Asa adicional en diámetros grandes.
Additional handle on large diameters.

Cazuela aluminio
Aluminium casserole
Casserole aluminium
Casseruola in alluminio
Aluminiumkasserolle

REF.	Ø(mm)	e(mm)	H(mm)	€	UE / MOQ
11611	280	3	70	27,82	1-0-6 / 1
11612	320	3	80	33,39	1-0-6 / 1
11613	360	3	80	38,17	1-0-4 / 1
11615	400	3	90	45,63	1-0-4 / 1



MAGNA EXPERT COLLECTION

BATERIA PROFESIONAL ACERO INOXIDABLE.
STAINLESS STEEL PROFESSIONAL FRY PANS AND COOKWARE



CROSCAT COLLECTION

BATERIA PROFESIONAL ALUMINIO CON ANTIADHERENTE.
ALLUMINIUM PROFESSIONAL FRY PANS AND COOKWARE WITH NON-STICK COATING



ANTIADHERENTE / NON-STICK COATING

Doble capa antiadherente de alta calidad.

High quality double non-stick coating.

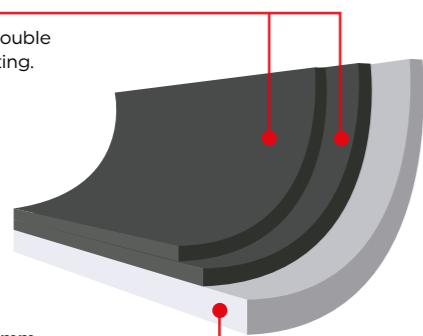

Aluminio de 3mm de espesor

3mm thick aluminium

El revestimiento antiadherente de fluororesina universal de PFLUON, con sistema de dos capas, es denso, fácil de limpiar y altamente eficaz. PFLUON colabora con SGS para certificar que sus productos, como el antiadherente COOKMARK, cumplen normas nacionales e internacionales.

PFLUON's universal-grade fluororesin nonstick coating features a dense, two-layer system that is easy to clean and highly effective. In partnership with globally recognized certification body SGS, PFLUON ensures that products like COOKMARK meet both international and local standards.



GAMA SARTENES PROFESIONALES

	CUERPO BODY	MANGO HANDLE	ANTIADHERENTE NON STICK COATING	COMPATIBILIDAD SUITABILITY
ETNA	ALUMINIO ALUMINIUM	INOX		
TEIDE	ALUMINIO ALUMINIUM	INOX		
VULCANO	ALUMINIO ALUMINIUM	INOX		
STROMBOLI	ALUMINIO ALUMINIUM	INOX		
CROSCAT	ALUMINIO ALUMINIUM	INOX		
AUVERNIA	ALUMINIO ALUMINIUM	HIERRO IRON		
USSON	ALUMINIO ALUMINIUM	HIERRO IRON		
FUJI	ACERO INOXIDABLE STAINLESS STEEL	INOX		
VESUVIO	ACERO INOXIDABLE STAINLESS STEEL	INOX		
ARENAL	TRIMETAL INOX + ALUMINIUM + INOX TRIMETAL INOX + ALUMINIUM + INOX	INOX		



Mango fabricado en acero inoxidable de forma tubular para facilitar la sujeción de la sartén.

Tubular stainless steel handle for easy handling.



ETNA

Sartén aluminio mango inox
Aluminium fry pan with inox handle
Poêle aluminium manche en inox
Padella in alluminio manico en inox
Bratpfanne aluminium mit inoxgriff

REF.	Ø(mm)	e(mm)	€	UE / MOQ
8342	180	2,5	15,09	1-0-6 / 1
8343	200	3,5	17,49	1-0-6 / 1
8344	220	3,5	20,93	1-0-6 / 1
8345	240	3,5	23,42	1-0-6 / 1
8346	260	4	26,82	1-0-6 / 1
8347	280	4	29,21	1-0-6 / 1
8348	320	4	36,27	1-0-6 / 1
8349	360	4	43,24	1-0-6 / 1
8350	400	4	52,20	1-0-6 / 1

Recubrimiento totalmente libre de PFOA.

Coating totally PFOA-free.



Remachado al cuerpo de la sartén para proporcionar una sujeción superior y una máxima seguridad en el momento de su uso.

Riveted to the pan for strength and safety in use.



TEIDE

Sartén aluminio mango inox / Inducción
Aluminium induction fry pan with inox handle
Poêle induction aluminium manche en inox
Padella induzione in alluminio manico en inox
Bratpfanne aluminium mit inoxgriff induktion

REF.	Ø(mm)	e(mm)	€	UE / MOQ
8954	200	3	17,06	1-0-6 / 1
8955	240	3	21,53	1-0-6 / 1
8956	280	3	26,51	1-0-6 / 1
8957	320	3	31,75	1-0-6 / 1
11778	360	3	40,56	1-0-6 / 1
11996	400	4	54,74	1-0-6 / 1

El cuerpo de aluminio de alta calidad capta y distribuye de la mejor manera el calor por toda la superficie.

The high-quality aluminium body captures and conducts heat across the whole surface.



VULCANO

Sartén aluminio antiadherente alta mango inox
Deep frypan, non stick coating
Poêle avec revêtement anti-adhésif
Padella inox antiaderente
Bratpfanne Aluminium mit inoxgriff

REF.	Ø(mm)	e(mm)	H(mm)	€	UE / MOQ
9971	200	3	55	17,32	1-0-6 / 1
9972	240	3	60	21,98	1-0-6 / 1
9973	280	3	65	28,64	1-0-6 / 1
9974	300	3	75	33,89	1-0-6 / 1
9975	360	3	80	43,81	1-0-6 / 1
9976	400	3	85	51,13	1-0-6 / 1



NEW



STROMBOLI

Sartén aluminio alta mango inox
Aluminium deep fry pan with inox handle
Poêle profond aluminium manche en inox
Padella alta in alluminio manico en inox
Aluminium-bratpfanne tief griff inox

REF.	Ø(mm)	e(mm)	H(mm)	€	UE / MOQ
9977	200	3	55	13,88	1-0-6 / 1
9978	240	3	60	18,75	1-0-6 / 1
9979	280	3	65	23,57	1-0-6 / 1
9980	320	3	75	26,25	1-0-6 / 1
9981	360	3	80	36,55	1-0-6 / 1
9982	400	3	85	42,47	1-0-6 / 1



4mm de grosor en tamaños grandes.
4mm thickness in large sizes.



AUVERNIA

Sartén aluminio mango hierro
Aluminium fry pan with iron handle
Poêle aluminium manche en fer
Padella in alluminio manico en ferro
Aluminium-Bratpfanne mit Eisengriff

REF.	Ø(mm)	e(mm)	€	UE / MOQ
8351	180	2,5	12,99	1-0-6 / 1
8352	200	3,5	16,52	1-0-6 / 1
8353	220	3,5	19,01	1-0-6 / 1
8354	240	3,5	22,14	1-0-6 / 1
8355	260	4	26,77	1-0-6 / 1
8356	280	4	29,06	1-0-6 / 1
8357	320	4	35,93	1-0-6 / 1
8358	360	4	42,30	1-0-6 / 1
8359	400	4	51,21	1-0-6 / 1



USSON

Sartén aluminio mango hierro / Inducción
Aluminium induction fry pan with inox handle
Poêle induction aluminium manche en inox
Padella induzione in alluminio manico en inox
Induktion aluminium-Bratpfanne mit inoxgriff induktion

REF.	Ø(mm)	e(mm)	€	UE / MOQ
8958	200	3	19,08	1-0-6 / 1
8959	240	3	24,11	1-0-6 / 1
8960	280	3	28,28	1-0-6 / 1
8961	320	3	33,88	1-0-6 / 1

CAPA INTERIOR
ALUMINIO

INTERIOR LAYER
ALUMINIUM



CAPAS EXTERIORES
ACERO INOXIDABLE
SUPERIOR
Mezcla cromo, titanio y
cobre.

EXTERIOR LAYERS
SUPERIOR STAINLESS
STEEL
Mixing chrome, titanium
and copper.



- **Alta resistencia a la corrosión y los ácidos alimentarios.**
Highly resistant to rust and food acids.
- **Óptima difusión del calor por toda la superficie.**
Optimum heat distribution across the whole base.
- **Muy resistente a las altas temperaturas y al desgaste.**
Hard-wearing and tolerant of high temperatures.



Base sistema
SANDWICH
SANDWICH system
base



FUJI

Sartén inox mango inox
Frypan inox
Poêle à frire inox
Padella inox
Inox-Bratpfanne

REF.	Ø(mm)	E(mm)	€	UE / MOQ
8515	200	0,7	21,37	1-0-6 / 1
8516	240	0,7	26,24	1-0-6 / 1
8517	280	0,7	34,43	1-0-6 / 1
* 8518	320	1	50,42	1-0-4 / 1
* 8519	360	1	60,48	1-0-4 / 1
* 8520	400	1	72,22	1-0-4 / 1



Asa adicional en
diametros grandes.
Additional handle on
large diameters.



VESUVIO

Sartén inox antiadherente mango inox
Frypan, non stick coating
Poêle avec revêtement anti-adhésif
Padella inox antiaderente
Bratpfanne mit Antihftbeschichtung

REF.	Ø(mm)	E(mm)	€	UE / MOQ
8509	200	0,7	26,56	1-0-6 / 1
8510	240	0,7	33,65	1-0-6 / 1
8511	280	0,7	43,68	1-0-6 / 1
* 8512	320	1	62,28	1-0-4 / 1
* 8513	360	1	75,77	1-0-4 / 1
* 8514	400	1	89,97	1-0-4 / 1

NEW

Sartén Trimetal Profesional
Professional Trimetal Frying pan

Interior INOX 18/10 (AISI 304)
Máxima seguridad alimentaria, fácil
limpieza e higiene garantizada.

Interior S.S. 318/10 (AISI 304)
Ensures food safety, easy cleaning, and
maximum hygiene.

Capa intermedia de aluminio.
Excelente conductividad térmica
y distribución uniforme del calor.

Core Aluminum layer.
Delivers excellent thermal conductivity
and even heat distribution.

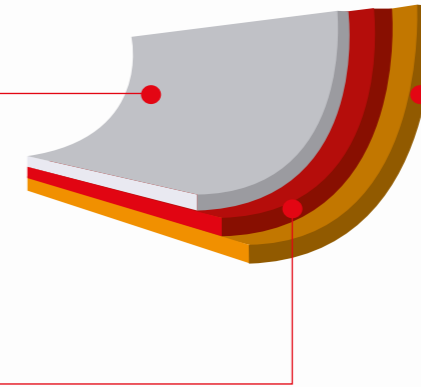

Exterior INOX 18/0 (AISI 430)
Alta durabilidad y compatibilidad con
cocinas de inducción.

Exterior S.S. (AISI 430)
Exceptional durability and induction
compatibility.

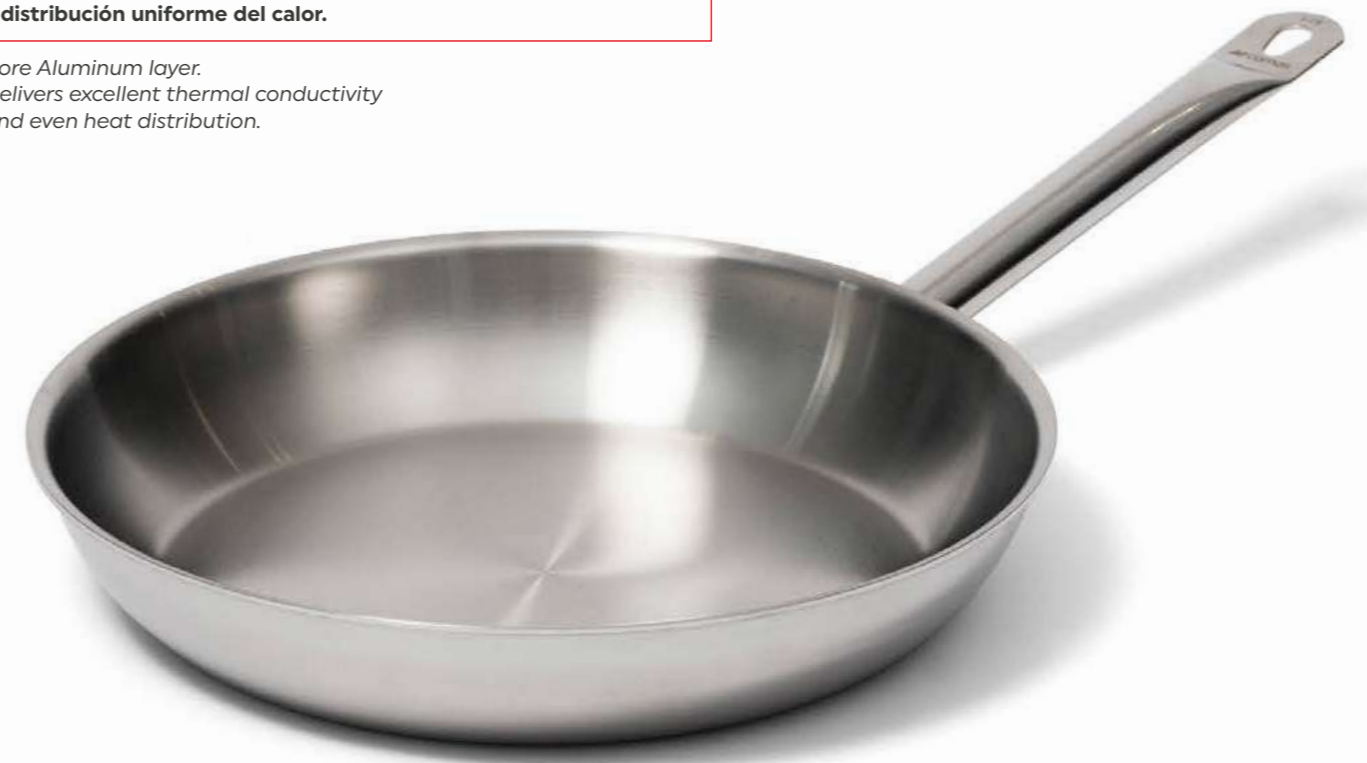

- **Reparto homogéneo del calor: Fabricación en una sola pieza que permite una cocción uniforme en fondo y paredes.**

Uniform heat distribution: One-piece design allows for consistent heating across the base and sides.

- **Calentamiento rápido y eficaz: Ahorra tiempo y energía en cada preparación.**

Fast and efficient heating: Saves energy and reduces cooking time.

- **Apta para uso profesional: Rendimiento fiable en cocinas de alto rendimiento y uso cotidiano.**

Suitable for professional use: Reliable performance for demanding kitchens and everyday cooking.



ARENAL

Sartén inox TRIMETAL
3-ply multi-layer frying pan
Poêle multicouche 3 plis
Padella multistrato a 3 strati
Mehrschichtige 3-lagige bratpfanne

REF.	Ø(mm)	E(mm)	€	UE / MOQ
12183	200	2,5	26,61	1-0-6 / 1
12184	240	2,5	32,18	1-0-6 / 1
12185	280	2,5	39,62	1-0-6 / 1
12186	320	2,5	52,83	1-0-4 / 1
12187	360	2,5	69,30	1-0-4 / 1



Grill asa BK
Grill BK handle
Gril asa BK
Griglia manico BK
Grillgriff BK



REF.	WxL(mm)	e(mm)	€	UE / MOQ
10044	260x260	0,7	87,83	1-0-8 / 1

MANGO
BAQUELITA
BAKELITE
HANDLE
200°C

Disponibile en 3 colores
Available in 3 colours



Grill mango silicona abatible
Grill "xl" silicone handle
gril manche rabattable
griglia maniglie estraibile
gril ausziehbar griff



REF.	WxL(mm)	e(mm)	H(mm)	€	UE / MOQ
10811	260x330	0,7	50	69,70	1-0-6 / 1



Grill ovalado para pescado
Oval fish grill
Grill à poisson ovale
Pesciera ovale
Ovale Fischpfanne



REF.	WxL(mm)	€	UE / MOQ
10039	460x265	74,98	1-0-6 / 1

ALUMINIO
FUNDIDO
CAST
ALUMINIUM



Huevo & dulce
Egg & sweet
Oeuf & sucré
Uovo e dolce
Ei & süß



REF.	Ø(mm)	e(mm)	H(mm)	€	UE / MOQ
10022	140/5,5"	0,5	30	30,03	1-0-0 / 1

PORCIÓN
INDIVIDUAL
INDIVIDUAL
PORTION



Compatible con (p.327)
10066 - 10067 - 10068 - 10069
Cacerola grand gourmet
Grand gourmet saucepan
Casserole grand gourmet
Casseruola grand gourmet
Kasserolle grand gourmet

REF.	Ø(mm)	ml	e(mm)	H(mm)	€	UE / MOQ
10027	240/9,4"	200	0,6	70	61,27	1-0-6 / 1
10028	280/11"	300	0,6	75	75,47	1-0-6 / 1
10029	320/12,5"	450	0,6	85	87,90	1-0-4 / 1
10030	360/14,1"	550	0,6	85	117,65	1-0-5 / 1



Plancha grill GN
GN grill
Plaque de cuisson GN
Piastra Griglia GN
Grill Platte GN



SIZE
1/1
GN

REF.	WxL(mm)	e(mm)	H(mm)	€	UE / MOQ
10045	530x325	0,7	20	276,89	1-0-10 / 1



GN 1/1

REF.	WxL(mm)	e(mm)	H(mm)	€	UE / MOQ
10046	530x320	1,5	20	64,10	1-0-10 / 1
10047	530x320	1,5	40	71,56	1-0-10 / 1
10048	530x320	1,5	65	84,87	1-0-10 / 1



GN 2/3

REF.	WxL(mm)	e(mm)	H(mm)	€	UE / MOQ
10051	355x325	1,5	65	62,30	1-0-10 / 1

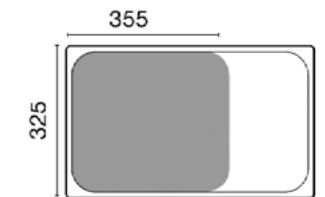

GN 1/2

REF.	WxL(mm)	e(mm)	H(mm)	€	UE / MOQ
10053	265x325	1,5	20	43,69	1-0-10 / 1
10963	265x325		40	52,90	

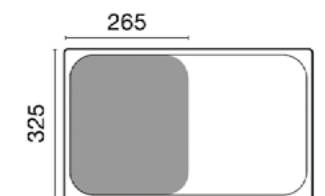



EL SALER

Paellera acero pulido
Polished steel spanish paella pan
Plat à paella tole acier
Padella valenciana lucida
Paellapfanne aus poliertem Stahl

REF.	Ø(mm)	RACIONES	€	UE / MOQ
8964	300	4	9,46	1-0-6 / 1
8965	340	6	11,47	1-0-6 / 1
8966	380	8	14,17	1-0-6 / 1
8967	42	10	17,57	1-0-6 / 1
8968	460	12	20,67	1-0-4 / 1
8969	500	13	23,65	1-0-4 / 1
8970	600	20	44,99	1-0-4 / 1
10937	650	25	61,10	1-0-0 / 1
10938	700	30	80,36	1-0-0 / 1
10939	800	40	110,15	1-0-0 / 1
10940	900	50	152,49	1-0-0 / 1



Paellera grande acero pulido
Polished steel spanish paella pan
Plat à paella tole acier
Padella valenciana lucida
Paellapfanne aus poliertem Stahl

BAJO PEDIDO
ON DEMAND

REF.	Ø(mm)	RACIONES	€	UE / MOQ
10941	1000	85	287,38	1-0-0 / 1
10942	1150	120	357,87	1-0-0 / 1
10943	1300	200	717,09	1-0-0 / 1



Paellera ración
Paella pan
Poêle à paella
Padella
Paella-pfannen

REF.	Ø(mm)	H(mm)	€	UE / MOQ
7792	100	20	4,76	1-10-100 / 1
7793	120	22	5,21	1-10-100 / 1
7794	150	24	6,26	1-10-80 / 1
7795	200	26	8,06	1-6-36 / 1



Sartén honda ración
Deep frying pan
Poêle profonde
Padella
Mini-pfannen

REF.	Ø(mm)	H(mm)	€	UE / MOQ
7826	140	38	5,81	1-10-60 / 1
7827	160	43	6,34	1-10-50 / 1
7828	180	48	7,16	1-6-36 / 1
7829	200	53	7,69	1-6-42 / 1

Quemador de cocción para uso doméstico y/o profesional. Fabricado en acero y recubierto de una capa de esmalte. Diseñado para ser utilizado en el exterior.

Burner for domestic or professional use. Made of enameled steel. Designed for outdoor use.



Fuente acero esmaltada con asas
Deep enamelled fry pan with handles
Poele haute avec anses
Padella smaltata con manici
Emaillierte platte mit griffen

REF.	Ø(mm)	€	UE / MOQ
10934	120	5,25	1-6-48 / 1
10935	160	6,41	1-6-48 / 1
10936	200	7,46	1-6-48 / 1



Quemador paellero a gas
Enamelled gas burner
Brulleur émaillé
Bruciatore smaltato padella
Emailliertes Gasbrenner



REF.	Ø(mm)	COMPATIBLE CON	€	UE / MOQ
8985	30	36 - 42cm	38,30	1-0-1 / 1
8986	40	26 - 60CM	67,52	1-0-1 / 1
8987	50	36 - 70CM	79,52	1-0-1 / 1



ENAMELLED
IRON



RIBA ROJA

Paellera acero esmaltado
Enamelled steel paella pan
Plat à paella acier émaillé
Padella valenciana smaltata
Paellapfanne aus emailliertem Stahl

REF.	Ø(mm)	RACIONES	€	UE / MOQ
8971	300	4	13,67	1-0-6 / 1
8972	340	6	16,43	1-0-6 / 1
8973	380	8	20,27	1-0-6 / 1
8974	420	10	26,90	1-0-6 / 1
8975	460	12	31,44	1-0-4 / 1
8976	500	13	36,68	1-0-4 / 1
8977	600	20	59,74	1-0-4 / 1



ALBUFERA

Sartén honda acero esmaltado
Deep enamelled fry pan with handles.
Poele haute avec anses.
Padella smaltata con manici.
Tiefe Paellapfanne aus emailliertem Stahl mit Griffen.

REF.	Ø(mm)	RACIONES	€	UE / MOQ
8978	280		13,60	1-0-6 / 1
8979	320		16,39	1-0-6 / 1
8980	360		20,03	1-0-4 / 1
8981	400		24,90	1-0-4 / 1
8982	450		34,51	1-0-3 / 1
8983	500		45,65	1-0-3 / 1



Tripede regulable para quemador
Base for burner
Pied pour bruleur
Treppiede padella
Dreifussständer für Gasbrenner

REF.	W(mm)	H(mm)	€	UE / MOQ
8984	300	300	44,01	1-0-1 / 1

Paravientos 3 piezas
Windshield
Pare-bris 3 pieces
Paravento 3 pezzi
Windschutzsblech

REF.	W(mm)	H(mm)	€	UE / MOQ
8505	670	160	42,54	1-0-1 / 1



* Tripede no incluido.
Tripod not included.



Quemador paellero a gas grande
Enamelled gas burner
Brulleur émaillé
Bruciatore smaltato padella
Emailliertes Gasbrenner

REF.	Ø(mm)	COMPATIBLE CON	€	UE / MOQ
10944	90		883,05	1-0-1 / 1

Este producto está certificado según la normativa de gas vigente. Conexión roscada especial para Gas Natural.

También disponible bajo demanda para otras conexiones europeas.

This product has been certified under the law relating to gas appliances. Threaded Natural Gas connector.

Available on request to fit other European connectors.

BAJO PEDIDO
ON DEMAND



CORTE, UTENSILIOS, GN Y BRASA

CORTE CUTTING

- 330 130 COLLETION
- 332 MESTRE MAURICI
- 336 ZEN
- 340 MARBLE
- 344 IBÉRICA - GRAFIT
- 348 PUNTILLAS
- 350 TABLAS DE CORTE
- 354 ACCESORIOS CORTE
- 358 MANTENIMIENTO Y CUIDADO
- 360 RALLADORES Y ACCESORIOS

ACCESORIOS ACCESSORIES

- 366 ESPATULAS
- 368 EMPLATADO
- 370 UTENSILIOS

GASTRONORM

- 380 CUBETAS GN 18/10
- 384 CUBETAS GN 18/0
- 389 CARROS

BRASA GRILL

- 392 BBQ
- 394 ACCESORIOS
- 395 ROBATA YAKI
- 397 KITS
- 398 LLAUNES
- 398 CARACOLERAS
- 398 IGNIS
- 400 PLATO HIERRO FUNDIDO
- 401 PLATO PIEDRA BASALTO
- 402 ACCESORIOS
- 404 CARBÓN

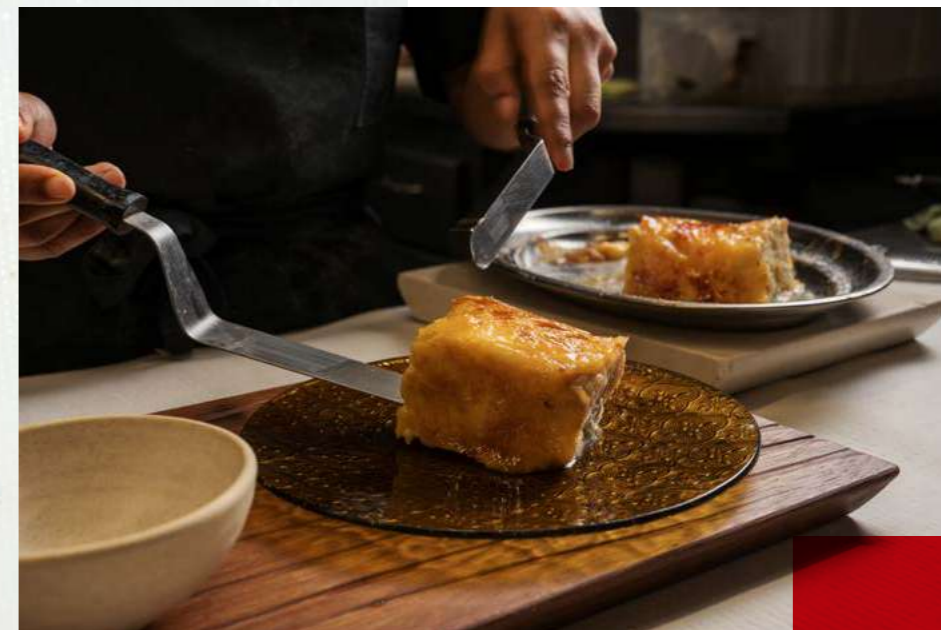

Soluciones profesionales de corte

En las cocinas, junto a los profesionales más exigentes, dando respuestas a las precisas y variadas necesidades de corte. Desde Comas ofrecemos un conjunto amplio de soluciones de corte creadas para ofrecer a cocineros, jefes de cocina y sus equipos, opciones de calidad, durabilidad, versatilidad y adecuación a cada preparación, a cada creación.

Nuestra extensa gama de cuchillos en sus diversos acabados y materiales, junto a las tablas de corte, afiladores, tijeras y ralladores, es una muestra más de nuestra vocación de ofrecer herramientas para el profesional experto.

Soluciones profesionales de corte

En las cocinas, junto a los profesionales más exigentes, dando respuestas a las precisas y variadas necesidades de corte. Desde Comas ofrecemos un conjunto amplio de soluciones de corte creadas para ofrecer a cocineros, jefes de cocina y sus equipos, opciones de calidad, durabilidad, versatilidad y adecuación a cada preparación, a cada creación.

Nuestra extensa gama de cuchillos en sus diversos acabados y materiales, junto a las tablas de corte, afiladores, tijeras y ralladores, es una muestra más de nuestra vocación de ofrecer herramientas para el profesional experto.



PUNTILLA / MONDADOR / UTILITY

Versátil, tanto para fruta y verdura, como para piezas pequeñas de carne. Versatile, both for fruit and vegetables, as well as for small pieces of meat.



PELADOR / VERDURAS / PEELING

Para trabajos pequeños y delicados. For small and delicate jobs.



DESHUESADOR / WRECKER

Su forma permite acceder a la carne y retirar huesos y tendones sin perder la forma. Its shape allows access to the flesh and the removal of bones and tendons without losing its shape.



JAMONERO / SLICER

Indicado para cortar jamón y carnes curadas. Suitable for cutting ham and cured meats.



SALMÓN / SALMON KNIFE

Hoja fina y alargada, con alvéolos para evitar que la carne se adhiera a la hoja. Thin, elongated blade, with sockets to prevent meat from sticking to the blade.



PANERO / BREAD KNIFE

Hoja dura y dentada que permite cortar alimentos con el exterior rígido con facilidad. Hard, serrated blade for easy cutting of food with a rigid exterior.



HACHA / CLEAVER

Hoja grande y gruesa que se utiliza para cortar y desosar carne cruda o cocinada. A large, thick blade used for cutting and boning raw or cooked meat.



FILETADOR / SLICER

Hoja larga y flexible que permite preparar carne y pescado con precisión. Long, flexible blade for precise meat and fish preparation.



SANTOKU / SANTOKU

Versión japonesa del cuchillo chef, ideal para preparar carne, pesca y verduras. Japanese version of the chef's knife, ideal for preparing meat, fish and vegetables.



CHEF / CHEF

El más popular de los cuchillos, con hoja grande y resistente sirve para todo tipo de cortes. The most popular of the knives, with a large, sturdy blade for all types of cutting.

La gama de productos de corte Comas, ha sido creada y mejorada para ofrecer a los cocineros y jefes de cocina, una amplia variedad de utensilios y cuchillos para corte que garantizan la calidad y durabilidad necesaria para el día a día de las cocinas profesionales.

The Comas range of cutting products has been created and improved to offer chefs and wide variety of cutting utensils and knives that guarantee the quality and durability necessary for everyday use in professional kitchens.



COLECCIÓN
COLLECTION

GRANITE	IBERICA	MARBLE	ZEN	130	MAURICI
---------	---------	--------	-----	-----	---------



MATERIAL	X50 Cr Mo V15	X50 Cr Mo V15	DIN 1.4116	AUS 8 SANMAI	AUS 10 SANMAI	CARBON STEEL 52100
DUREZA DE LA HOJA BLADE HARDNESS	HRC55 ± 57	HRC55 ± 57	HRC55 ± 2	HRC58 ± 2	HRC60 ± 1	HRC62 ± 2
MANGO HANDLE	POLIPROPILENO	POLIPROPILENO	ABS	POM	MADERA DE ÉBANO EBONY WOOD	ABEDUL ESTABILIZADO ABEDUL ESTABILIZADO
ORIGEN MATERIA PRIMA RAW MATERIAL ORIGIN	ALEMANIA GERMANY	ALEMANIA GERMANY	ALEMANIA GERMANY	JAPÓN JAPAN	JAPÓN JAPAN	JAPÓN JAPAN
LAVAVAJILLAS DISHWASHER	✓	✓	✗	✗	✗	✗

ACERO:
SANMAI AUS10

DUREZA:
HARDNESS 60 ± 1 HRC



NEW

Cuchillo fileteador
Carving knife
Couteau à filet
Coltello sfilettatore
Filetirmesser



REF.	HOJA(mm)	L(mm)	€	UE / MOQ
11605	235	385	141,40	1-0-0 / 1

Cuchillo Fileteador
Carving Knife
Couteau À Filet
Coltello Sfilettatore
Filetirmesser



REF.	HOJA(mm)	L(mm)	€	UE / MOQ
11023	180	320	138,20	1-0-0 / 1

Cuchillo Puntilla
Paring Knife
Couteau À Pointe
Coltello Da Cucina Professionale
Ausbeinmesser



REF.	HOJA(mm)	L(mm)	€	UE / MOQ
11024	100	213	88,21	1-0-0 / 1

Cuchillo chef
Chef's knife
Couteau chef
Coltello chef
Küchenmesser



REF.	HOJA(mm)	L(mm)	€	UE / MOQ
11022	210	365	151,59	1-0-0 / 1

NEW

Cuchillo Kiritsuke
Kiritsuke Knife
Couteau Kiritsuke
Coltello Kiritsuke
Kiritsuke-Messer



REF.	HOJA(mm)	L(mm)	€	UE / MOQ
11606	170	313	151,59	1-0-0 / 1

Exterior:
Acero inoxidable AISI 430

Outer layers:
AISI 430 stainless steel.

Núcleo:
Acero de aleación (AUS10)

Core: Alloy steel (AUS10)



PIN
Mosaico de la familia UTSET con sus cuatro puntos generacionales.

Mosaic of the UTSET family with its four generational points.



HOJA / BLADE

Acero japonés
SANMAI AUS10
Dureza 60 1 HRC

Japanese steel
SANMAI AUS10
Hardness 60 1 HRC

VIROL / FERRULE

Diseñada para distintos agarres.
Anillo de raíz estabilizada.

Designed for different grips.stabili-
sed root ring.

MANGO / HANDLE

Cuerpo de madera
de ébano.

Ebony wood body.

El acero japonés AUS10 destaca como una opción versátil y de alta calidad entre los aceros japoneses para cuchillos.

Con una dureza notable que oscila entre 58 y 60 HRC y un contenido en cromo de aproximadamente el 13%, este acero ofrece una excelente resistencia a la corrosión, garantizando una larga durabilidad y rendimiento.

Japanese AUS10 stands out as a versatile and high quality choice among Japanese knife steels.

With a remarkable hardness ranging from 58 to 60 HRC and a chromium content of approximately 13%, this steel offers excellent corrosion resistance, ensuring long durability and performance.

NEW

Cuchillo Panero
Bread knife
Couteau à pain
Coltello da pane
Brotmesser



REF.	HOJA(mm)	L(mm)	€	UE / MOQ
12020	210	360	113,35	1-0-0 / 1

NEW



Tenedor Trinchador
Carving fork
Fourchette à découper
Forchetta da intaglio
Tranchiergabel



REF.	HOJA(mm)	L(mm)	€	UE / MOQ
12021	160	306	47,83	1-0-0 / 1

ACERO DE CARBONO

El 52100 es un acero al cromo con alto contenido en carbono que ha ganado popularidad en el mundo de la cuchillería para hojas de alto rendimiento.

Conocido por su excepcional dureza, resistencia al desgaste y retención del filo, se utiliza a menudo en cuchillos personalizados de gama alta que requieren una durabilidad superior.

Al ser un cuchillo no inoxidable, se le ha aplicado una pátina negra en toda la hoja para evitar que se oxide fácilmente. Aún así aconsejamos lavarlo siempre a mano y secarlo rápido.

Si se guarda durante tiempo es aconsejable untar de aceite mineral la hoja y la espiga así como guardarlo protegido con funda o saya.

CARBON STEEL

52100 is a high-carbon chrome steel that has gained popularity in the world of high-performance knife making.

Known for its exceptional hardness, wear resistance and edge retention, it is often used in high-end custom knives that require superior durability.

As a non-stainless knife, a black patina has been applied to the entire blade to prevent it from rusting easily. Even so, we advise to always wash it by hand and dry it quickly.

If it is stored for a long time, it is advisable to smear mineral oil on the blade and tang and to keep it protected with a saya.



PACKAGING BOX

RAÍZ DE ABEDUL ESTABILIZADA

El mango, de raíz de abedul estabilizada proporciona a la colección la elegancia de una madera noble.

El proceso de estabilización protege y sella la porosidad de la madera para garantizar una mayor durabilidad y resistencia, además de resultar muy agradable al tacto.

Aún siendo un material duradero y resistente es importante evitar el lavavajillas y mantener siempre el cuchillo seco.

STABILISED BIRCH ROOT

The handle, made of stabilised birch root, gives the collection the elegance of a noble wood.

The stabilisation process protects and seals the porosity of the wood to ensure greater durability and strength, as well as being very pleasant to the touch.

Yet being a durable and resistant material, it is important to avoid dishwashing and to always keep the knife dry.

HASAKI

Parte afilada que se convierte en el filo del cuchillo.

The sharp part that becomes the cutting edge of the knife.

Hoja fabricada con acero al carbono, conocido por su capacidad de mantener un filo excepcional y su facilidad para ser afilados.

Blade made of carbon steel, known for its ability to maintain an exceptional sharpness and ease of sharpening.

HAMOTO

Parte del filo cerca del mango. Al cortar pescado crudo para hacer sashimi, normalmente se corta desde el hamoto.

Part of the blade near the handle. When cutting raw fish for sashimi, it is usually cut from the hamoto.

KIREHA

Parte final de la hoja, normalmente con forma curva para facilitar el agarre del cuchillo.

The end of the blade, usually curved to make it easier to grip the knife.

PASADOR PIN MOSAICO

Con 4 puntos de acero que representan las 4 generaciones con 130 años de experiencia y pasión por los cuchillos

With 4 steel points representing the 4 generations with 130 years of experience and passion for knives.

KISSAKI

La punta de la hoja. Puede variar de forma según el tipo de cuchillo. Se utiliza el realizar cortes en carnes y pescado o en esculpir verduras.

The tip of the blade. It can vary in shape depending on the type of knife. Used for cutting meat and fish or carving vegetables.

MINE

Columna vertebral de la hoja. Parte opuesta al filo.

Spine of the blade. The part opposite the blade.

AGO

Parte más ancha y gruesa de la hoja. Se usa para tareas que requieren más precisión, como cortar alimentos más duros.

The wider, thicker part of the blade. Used for tasks requiring more precision, such as cutting harder foods.

E

Cuerpo principal del mango.

Main body of the handle.

Mango fabricado con raíz de abedul estabilizada. Muy agradable al tacto y mucho más resistente al lavado.

Handle made of stabilised birch root. Very pleasant to the touch and much more resistant to washing.



Cuchillo Fileteador
Slicer
Couteau à filet
Coltello sfilettatore
Filetierre



REF.	HOJA(mm)	L(mm)	€	UE / MOQ
11657	235	367	101,39	1-0-0 / 1

Cuchillo Fileteador
Slicer
Couteau à filet
Coltello sfilettatore
Filetierre



REF.	HOJA(mm)	L(mm)	€	UE / MOQ
11609	185	312	88,92	1-0-0 / 1

Cuchillo Verduras
Petty knife
Couteau à légumes
Coltello per verdure
Gemüsemesser



REF.	HOJA(mm)	L(mm)	€	UE / MOQ
11659	150	265	82,79	1-0-0 / 1

Cuchillo Puntilla
Utility knife
Couteau à pointe
Coltello da cucina
Ausbeinmesser



REF.	HOJA(mm)	L(mm)	€	UE / MOQ
11610	100	212	70,32	1-0-0 / 1

Cuchillo Chef
Chef's knife
Couteau chef
Coltello chef
Küchenmesser



REF.	HOJA(mm)	L(mm)	€	UE / MOQ
11608	215	351	101,93	1-0-0 / 1

Cuchillo Kiritsuke
Kiritsuke knife
Couteau Kiritsuke
Coltello Kiritsuke
Kiritsuke-Messer



REF.	HOJA(mm)	L(mm)	€	UE / MOQ
11658	170	300	91,09	1-0-0 / 1

Cuchillo Santoku
Santoku Knife
Couteau Santoku
Coltello Santoku
Santoku-Messer



REF.	HOJA(mm)	L(mm)	€	UE / MOQ
11660	170	302	64,59	1-0-0 / 1



Funda Saya Madera
Saya wooden sheath
Étui en bois saya
Custodia saya in legno
Holzkiste saya



REF.	HOJA(mm)	L(mm)	€	UE / MOQ
11083	CHEF	215	18,05	1-12-120 / 1
11084	FILETEADOR	185	16,30	1-12-120 / 1
11085	PUNTILLA	100	12,93	1-12-120 / 1
11086	FILETEADOR	235	18,05	1-12-120 / 1
11087	KIRITSUKE	170	16,59	1-12-120 / 1
11088	VERDURAS	150	13,86	1-12-120 / 1
11661	SANTOKU	170	11,22	1-12-120 / 1



La colección de cuchillos ZEN está diseñada para perdurar en el tiempo. Se caracteriza por su diseño elegante y minimalista que refleja la estética japonesa convirtiéndola en una pieza tradicional, innovadora e imprescindible para complementar cualquier cocina.

Esta colección es ideal para aquellos que buscan calidad, rendimiento y belleza en una sola herramienta. El filo tiene un excelente afilado que facilita el corte preciso de cualquier ingrediente.

The ZEN knife collection is designed to last over time. It is characterised by its elegant and minimalist design that reflects Japanese aesthetics, making it a traditional, innovative and essential piece to complement any kitchen.

This collection is ideal for those looking for quality, performance and beauty in a single tool. The cutting edge has an excellent sharpness that facilitates the precise cutting of any ingredient.



PACKAGING BOX

ACERO:
AUS8

DUREZA:
HRC 58 ± 2



ACERO SAN MAI 3 CAPAS
SAN MAI STEEL 3 LAYERS

Exterior:
Acero inoxidable SUS 1A-1

Outer layers:
SUS 1A-1 stainless steel.

Núcleo:
Acero de aleación (AUS8)

Core: Alloy steel (AUS8)

Diseño ergonómico para un mejor agarre. Acabado suave y satinado.

Ergonomic design for a better grip.

CUCHILLOS DE COCINA
KITCHEN KNIVES

Afilado en "V" para una mejor precisión en el corte.

With V-grind for a finer cut.

Virola 18/0 con estructura de espiga completa.

18/10 Ferrule full tang structure.

Cuchillo chef
Chef knife
Couteau chef
Coltello chef
Chef messer

REF.	HOJA(mm)	L(mm)	€	UE / MOQ
10967	210	335	70,73	1-6-36 / 1

SAN MAI, significa "3 capas" en japonés y es una técnica tradicional de forjado de cuchillos que consiste en la combinación de diferentes tipos de acero con una estructura laminada, con el fin de aprovechar las mejores características de cada material.

NÚCLEO: El AUS-8 es una opción versátil para los cuchillos de acero inoxidable. Es un acero con un rendimiento sólido.

EXTERIOR: A ambos lados del núcleo encontramos un acero más suave y resistente a la corrosión, protegiendo el núcleo de impactos y roturas.

SAN MAI, which means '3 layers' in Japanese, is a traditional knife forging technique that consists of combining different types of steel in a laminated structure, in order to take advantage of the best characteristics of each material.

CORE: AUS-8 is a versatile choice for stainless steel knives. It is a steel with a solid performance.

EXTERIOR: On both sides of the core is a softer, corrosion resistant steel, protecting the core from impact and breakage.

ACERO:
AUS8DUREZA:
HRC 58 ± 2CUCHILLOS DE COCINA
KITCHEN KNIVES

Cuchillo fileteador
Sharpening steel
Fusil
Acciaini
Tranchiermesser

REF.	HOJA(mm)	L(mm)	€	UE / MOQ
10970	240	365	90,35	1-6-36 / 1

Cuchillo fileteador
Slice knife
Couteau tranche
Coltello fetta
Tranchiermesser

REF.	HOJA(mm)	L(mm)	€	UE / MOQ
10966	180	290	62,01	1-6-36 / 1

Cuchillo verduras
Vegetable knife
Couteau à légumes
Coltello per verdure
Gemüsemesser

REF.	HOJA(mm)	L(mm)	€	UE / MOQ
10965	145	275	40,42	1-6-36 / 1

Cuchillo puntilla
Peeling knife
Couteau éplucheur
Coltello da cucina professionale
Schälmesser

REF.	HOJA(mm)	L(mm)	€	UE / MOQ
10964	90	205	35,54	1-6-36 / 1

Cuchillo nakiri
Nakiri knife
Couteau nakiri
Coltello nakiri
Nakiri messer

REF.	HOJA(mm)	L(mm)	€	UE / MOQ
10969	165	295	70,58	1-6-36 / 1

Cuchillo santoku
Santoku zen knife
Couteau santoku
Coltello santoku
Santoku-Messer

REF.	HOJA(mm)	L(mm)	€	UE / MOQ
10968	165	295	64,91	1-6-36 / 1

NEW

Cuchillo pan
Chef's knife
Couteau chef
Coltello chef
Küchenmesser

REF.	HOJA(mm)	L(mm)	€	UE / MOQ
12319	200	330	55,93	1-6-36 / 1

NEW

Chaira
Nakiri knife
Couteau nakiri
Coltello nakiri
Nakiri messer

REF.	HOJA(mm)	L(mm)	€	UE / MOQ
12320	200	325	31,47	1-6-36 / 1



La colección Marble está creada por 12 cuchillos exclusivos. Están realizados en acero alemán que garantiza la calidad por su alta resistencia. Este conjunto, caracterizado por su diseño funcional, destaca por su elegante color blanco. El aliado perfecto para cualquier profesional de la cocina

The Marble collection consists of 12 exclusive knives. They are made of German steel, which guarantees quality and high resistance. This set, characterised by its functional design, stands out for its elegant white colour. The perfect ally for any kitchen professional.

El acero alemán DIN 1.4116 es reconocido por su calidad excepcional y versatilidad, que lo convierte en uno de los materiales preferidos en la fabricación de cuchillos.

Su composición equilibrada ofrece una resistencia superior al desgaste y la oxidación, esto significa que mantienen el filo durante más tiempo y resisten un uso intensivo, algo esencial para los chefs.

German DIN 1.4116 steel is renowned for its exceptional quality and versatility, making it one of the preferred materials in knife making.

Its balanced composition offers superior resistance to wear and oxidation, which means it holds its edge longer and withstands intensive use - essential for chefs.



PACKAGING BOX

ACERO:
GERMAN STEEL
DIN 1.4116

DUREZA:
HRC55 ± 2



FILO: Afilado en "V" para una mejor precisión en el corte.

EDGE: With "V"-grind for a finer cut.

HOJA: Fabricado con acero alemán de alta calidad: DIN1.4116 HRC55 ± 2.

BLADE: Made with high-quality German steel: DIN1.4116 HRC55 ± 2.

REFUERZO: Cabezal cónico para un agarre cómodo y seguro.

REINFORCEMENT: Cone-shaped bolster for a comfortable, secure grip.

MANGO: Diseño ergonómico para un mejor agarre, proporcionando el equilibrio perfecto en la sujeción del cuchillo.

HANDLE: Ergonomically designed for better grip, giving perfect balance in the hand.

Proceso de endurecimiento de la hoja en frío para un afilado duradero y resistente al óxido.

Cold-hardened blade for a long-lasting, rust-free grind.

Remaches resistentes a la corrosión. Fabricado en ABS, le proporciona una mayor dureza y una alta resistencia al calor.

Rust-resistant rivets. Made from boron steel which makes it tougher and more heat resistant.

Talón acabado en acero inoxidable que proporciona protección y mayor robustez al mango.

Butt finished in stainless steel to provide protection and make the handle more durable.



MARBLE COLLECTION



Cuchillo chef 20
 Chef knife 20
 Couteau de cuisine 20
 Coltello chef 20
 Kochmesser 20

REF.	HOJA(mm)	L(mm)	€	UE / MOQ
8108	200/8"	320	30,16	1-6-36 / 1



Cuchillo chef 25
 Chef knife 25
 Couteau de cuisine 25
 Coltello chef 25
 Kochmesser 25

REF.	HOJA(mm)	L(mm)	€	UE / MOQ
8117	250/10"	380	31,68	1-6-36 / 1



Cuchillo fileteador
 Carving knife
 Couteau à filet
 Coltello per affettare
 Tranchiermesser

REF.	HOJA(mm)	L(mm)	€	UE / MOQ
8109	200/8"	320	23,84	1-6-36 / 1



Cuchillo panero
 Bread knife
 Couteau à pain
 Coltello pane
 Brotmesser

REF.	HOJA(mm)	L(mm)	€	UE / MOQ
8110	200/8"	320	24,28	1-6-36 / 1



Cuchillo Santoku
 Santoku knife
 Couteau Santoku
 Coltello Santoku
 Santoku-Messer

REF.	HOJA(mm)	L(mm)	€	UE / MOQ
8111	180/7"	300	30,31	1-6-36 / 1



Cuchillo jamonero
 Slicing knife
 Couteau à jambon
 Coltello da prosciutto
 Schinkenmesser

REF.	HOJA(mm)	L(mm)	€	UE / MOQ
8116	260/8"	385	19,02	1-6-36 / 1

ACERO:
 GERMAN STEEL
 DIN 1.4116

DUREZA:
 HRC55 2



Cuchillo mini Santoku
 Mini Santoku knife
 Couteau mini Santoku
 Coltello mini Santoku
 Mini Santoku-Messer

REF.	HOJA(mm)	L(mm)	€	UE / MOQ
8112	125/5"	230	18,79	1-6-48 / 1



Cuchillo chuletero
 Steak knife
 Couteau à steak
 Coltello per bistecca
 Steakmesser

REF.	HOJA(mm)	L(mm)	€	UE / MOQ
8114	115/4,5"	220	12,27	1-6-48 / 1



Cuchillo deshuesador
 Boning knife
 Couteau de désossage
 Coltello disossato
 Ausbeinmesser

REF.	HOJA(mm)	L(mm)	€	UE / MOQ
8118	155/7,8"	280	20,85	1-6-36 / 1

CUCHILLOS DE COCINA
 KITCHEN KNIVES



Cuchillo verduras
 Utility knife
 Couteau à légumes
 Coltello multiuso
 Universalmesser

REF.	HOJA(mm)	L(mm)	€	UE / MOQ
8113	125/5"	230	16,33	1-6-48 / 1



Cuchillo Mondador
 Paring knife
 Couteau d'office
 Coltello sbucciatore
 Schälmesser

REF.	HOJA(mm)	L(mm)	€	UE / MOQ
8115	80/3,5"	190	16,33	1-6-48 / 1



Chaira
 Sharpening stiel
 Fusil
 Acciaini
 Wetzstahl

REF.	HOJA(mm)	L(mm)	€	UE / MOQ
8119	205/7,8"	325	12,74	1-6-36 / 1

El afilado de las hojas hecho manualmente. Garantiza un afilado perfecto y duradero.

Blades sharpening is carried out manually. Guarantee a perfect and durable sharpening.

La forma convexa de la hoja en ambas caras otorga a la hoja un grosor más continuado hasta el filo, garantizando una mayor firmeza en el corte. El pulido asegura un acabado liso e impecable.

The convex line of the blade on both sides grants the blade a more skiving continuing thickness up to the edge, ensuring a steadfast cutting. The polishing ensures a flawless flatening and finishing.



Alta calidad en el corte Resistencia a la corrosión

Strong cutting ability Resistant to corrosion.



Sello de calidad del fabricante y su compromiso de durabilidad y fiabilidad del producto.

Manufacturer's seal of quality and commitment to product durability and reliability.

TechFlex: Polímeros de PP con EVA para más sensibilidad, adherencia, confort y disminución de fatiga.

TechFlex: Polymers of PP with EVA for a more sensitivity, adhesion, comfort and decreased fatigue

Mangos ergonómicos y antideslizantes para una mayor sujeción.

Ergonomic, non-slip handles for a better grip.

ACERO: X50 CRMO V15 | **DUREZA:** 55-57 HRC



CUCHILLOS DE COCINA
KITCHEN KNIVES

	● 10088	Macheta 180 Cleaver 180 Couperet 180 Mannaietta 180 Hackmesser 180	46,08 €	UE / MOQ: 1-12-12 / 1
	● 10089	Hachuela 250 Cleaver 250 Couperet 250 Mannaietta 250 Hackmesser 250	71,26 €	UE / MOQ: 1-12-12 / 1
	● 10090	Macheta filetera 220 Fillets cleaver 220 Couperet filet 220 Mannaietta per affettare 220 Filetirmesser 220	31,30 €	UE / MOQ: 1-12-12 / 1
	● 10091	Macheta filetera 280 Fillets cleaver 280 Couperet filet 280 Mannaietta per affettare 280 Filetirmesser 280	36,15 €	UE / MOQ: 1-12-12 / 1
	● 10074 ● 10093 ● 10104 ● 10114 ● 10128	Cuchillo chef 180 Chef knife 180 Couteau de cuisine 180 Coltello chef 180 Kochmesser 180	18,39 €	UE / MOQ: 1-12-72 / 11
	● 10075 ● 10094 ● 10105 ● 10115 ● 10129	Cuchillo chef 200 Chef knife 200 Couteau de cuisine 200 Coltello chef 200 Kochmesser 200	22,44 €	UE / MOQ: 1-12-72 / 11
	● 10076 ● 10095 ● 10106 ● 10116 ● 10130	Cuchillo chef 250 Chef knife 250 Couteau de cuisine 250 Coltello chef 250 Kochmesser 250	24,67 €	UE / MOQ: 1-12-72 / 11
	● 10077 ● 10096 ● 10107 ● 10117 ● 10131	Cuchillo chef 300 Chef knife 300 Couteau de cuisine 300 Coltello chef 300 Kochmesser 300	29,87 €	UE / MOQ: 1-6-48 / 6

ACERO:
X50 CRMO V15

DUREZA:
55-57 HRC



● 10079 Cuchillo carnicero 160
● 10098 Butcher knife 160
● 10109 Couteau boucher 160
● 10119 Coltello scannare 160
● 10119 Fleischermesser 180

14,02 €

UE / MOQ:
1-12-72 / 1



● 10080 Cuchillo carnicero 180
● 10099 Butcher knife 180
● 10110 Couteau boucher 180
● 10120 Coltello scannare 180
● 10120 Fleischermesser 180

16,01 €

UE / MOQ:
1-12-172 / 1



● 10081 Cuchillo carnicero 200
● 10100 Butcher knife 200
● 10111 Couteau boucher 200
● 10121 Coltello scannare 200
● 10121 Fleischermesser 200

19,03 €

UE / MOQ:
1-12-72 / 1



● 10082 Cuchillo carnicero 240
● 10101 Butcher knife 240
● 10112 Couteau boucher 240
● 10122 Coltello scannare 240
● 10122 Fleischermesser 240

23,83 €

UE / MOQ:
1-12-72 / 1



● 10083 Cuchillo carnicero 300
● 10102 Butcher knife 300
● 10113 Couteau boucher 300
● 10123 Coltello scannare 300
● 10123 Fleischermesser 300

27,81 €

UE / MOQ:
1-6-48 / 1



● 10092 Cuchillo chuletero 130
Steak knife 130
Couteau à steak 130
Coltello per bistecca 130
Steakmesser 130

7,07 €

UE / MOQ:
1-12-60 / 1



● 10078 Cuchillo deshuesador 140
● 10097 Wrecker knife 140
● 10108 Couteau de desossage 140
● 10118 Coltello disossato 140
● 10118 Ausbeinmesser 140

12,19 €

UE / MOQ:
1-12-72 / 1



● 10084 Cuchillo pan y pastelero 250
● 10127 Bread and pastry knife 250
● 10127 Couteau à pain et pâtisserie 250
● 10127 Coltello pane 250
● 10127 Brotmesser 250

17,36 €

UE / MOQ:
1-12-72 / 1



● 10085 Cuchillo para fiambres 300
● 10124 Slicing knife 300
● 10124 Couteau à charcuterie 300
● 10124 Coltello affettati 300
● 10124 Tranchiermesser 300

21,53 €

UE / MOQ:
1-6-48 / 1



● 10086 Cuchillo salmón 300
● 10103 Salmon knife 300
● 10125 Couteau saumon 300
● 10125 Coltello salmone 300
● 10125 Lachsmesser 300

29,08 €

UE / MOQ:
1-6-48 / 1



● 10087 Cuchillo jamonero 280
● 10126 Ham knife 280
● 10126 Couteau à jambon 280
● 10126 Coltello prosciutto 280
● 10126 Schinkenmesser 280

19,42 €

UE / MOQ:
1-6-48 / 1



**Cuchillo fruta micro.**

Micro serrated fruit knife.

**Cuchillo chuletero.**

Steak knife.

**Cuchillo pelador.**

Peeling knife.

**Cuchillo multiusos.**

Micro serrated knife.

El 3Cr13MoV es un acero inoxidable sólido que ofrece una buena resistencia a la corrosión, dureza y de fácil afilado. Es ideal para aquellos que quieren un cuchillo de bajo mantenimiento y uso general. Se desempeña de manera óptima en las tareas típicas de corte.

3Cr13MoV is a solid stainless steel that offers good corrosion resistance, hardness and easy sharpening. It is ideal for those who want a low-maintenance, general-purpose knife. It performs optimally in typical cutting tasks.

ACERO:
3CR13

MANGO

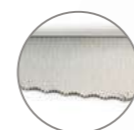
PUNTILLAS
PUNTILLAS

Cuchillo chuletero
Steak knife
Couteau steak
Coltello bistecca
Steakmesser

REF.	HOJA(mm)	L(mm)	€	UE / MOQ
7535	120	218	3,18	1-24-240 / 24
8301	BLISTER 2 U.		7,19	1-0-24 / 24

sierra microdentada
micro toothed saw

Cuchillo fruta micro
Micro serrated fruit knife
Couteau à fruits micro
Coltello fruta micro
Universalmesser Obst micr

REF.	HOJA(mm)	L(mm)	€	UE / MOQ
7538	88	199	3,18	1-24-240 / 24
8304	BLISTER 2 U.		7,19	1-0-24 / 24



Cuchillo chuletero
Steak knife
Couteau steak
Coltello bistecca
Steakmesser

REF.	HOJA(mm)	L(mm)	€	UE / MOQ
11585	120	218	3,18	1-0-240 / 24



Cuchillo pelador
Peeling knife
Couteau à éplucher
Coltello spellucchino
Schälmesser

REF.	HOJA(mm)	L(mm)	€	UE / MOQ
11586	80	199	3,04	1-0-240 / 24

sierra microdentada
micro toothed saw

Cuchillo multiusos micro
Micro serrated utility knife
Couteau multi-usage micro
Coltello multiuso micro
Universalmesser micro

REF.	HOJA(mm)	L(mm)	€	UE / MOQ
7537	100	209	3,28	1-24-240 / 24
8303	BLISTER 2 U.		7,38	1-0-24 / 24



Cuchillo pelador
Paring knife
Couteau à éplucher
Coltello spellucchino
Schälmesser

REF.	HOJA(mm)	L(mm)	€	UE / MOQ
7536	80	199	3,04	1-24-240 / 24
8302	BLISTER 2 U.		6,89	1-0-24 / 24



Cuchillo multiusos micro
Micro serrated utility knife
Couteau multi-usage micro
Coltello multiuso micro
Universalmesser micro

REF.	HOJA(mm)	L(mm)	€	UE / MOQ
11587	100	209	3,28	1-0-240 / 24



Cuchillo chuletero punta redonda
Micro serrated utility knife
Couteau multi-usage micro
Coltello multiuso micro
Universalmesser micro

REF.	HOJA(mm)	L(mm)	€	UE / MOQ
12039	100	230	2,82	1-0-240 / 24



Espesores de 2cm y 3cm.
2cm and 3cm Thicknesses.



Tacos antideslizantes de silicona para un mejor agarre en la superficie.

Silicone anti-slip pads for better grip on the surface.



Mayor rigidez. No se deforma con las altas temperaturas. Máx. 70°C

Higher rigidity, no deformation at high temperatures. Max. 70°C



Apto para contacto con alimentos.

Suitable for food contact.



Apto para lavavajillas.
Dishwasher safe.



Impermeable. No absorbe los líquidos.

SUPERFICIE AUTOCICATRIZANTE
Más higiénica. Evita que se acumule suciedad y bacterias en los cortes.

Waterproof, does not absorb liquids.

AUTOHEAL SURFACE
More hygienic, prevents dirt and bacteria from accumulating in the cuts.



POLIETILENO 500 DE ALTA DENSIDAD DE ALTO PESO MOLECULAR(HD-HMW)

HIGH MOLECULAR WEIGHT HIGH DENSITY POLYETHYLENE 500 (HD-HMW)

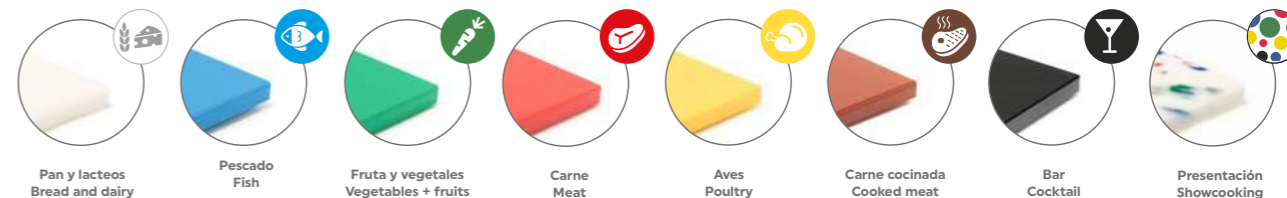

GN 1/1 GN 1/2 20x30cm 30x40cm 40x50cm 40x60cm



Tabla corte pan y lacteos blanca
White cutting board
Planche à découper blanche
Tagliere bianco
Wibes schneidebrett

REF.	W(mm)	L(mm)	ESPEJOR	TACOS	€	UE / MOQ
11756	GN 1/1	GN 1/1	3	6	55,80	1-0-4 / 1
8523	GN 1/2	GN 1/2	2	6	20,71	1-0-10 / 1
8525	300	200	2	4	14,00	1-0-8 / 1
8526	400	300	2	6	26,22	1-0-6 / 1
8527	500	300	2	6	32,41	1-0-6 / 1
11758	600	400	3	6	77,06	1-0-2 / 1

Tabla corte bar
Black cutting board
Planche à découper noir
Tagliere nero
Schwarzes schneinebrett

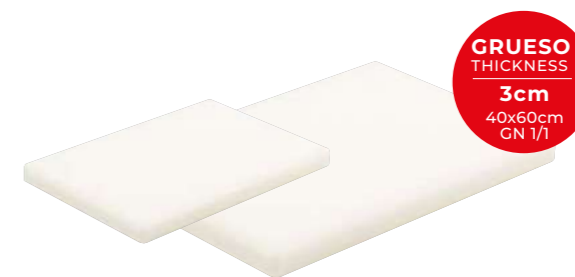
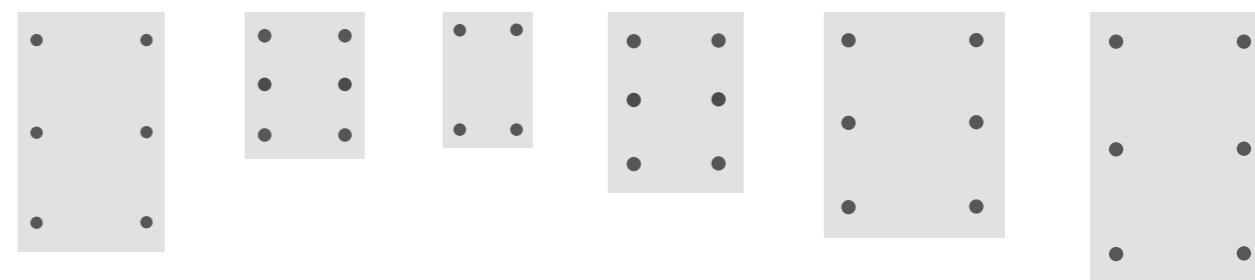

REF.	WxL(mm)	ESPEJOR	TACOS	€	UE / MOQ
11760	300x200	2	4	14,00	1-0-8 / 1
11759	400x300	2	6	26,10	1-0-6 / 1

**Tabla corte presentación**

Cutting board presentation
Présentation de la planche à découper
Presentazione del tagliere
Präsentation des schneidebrett



REF.	W(mm)	L(mm)	ESPEJOR	TACOS	€	UE / MOQ
11998	300	200	2	4	25,71	1-0-8 / 1

Tabla corte pescado azul

Blue cutting board
Planche à découper bleu
Tagliere blue
Blau schneidebrett



REF.	W(mm)	L(mm)	ESPEJOR	TACOS	€	UE / MOQ
8529	GN 1/1	GN 1/1	2	6	36,07	1-0-5 / 1
8532	300	200	2	4	14,00	1-0-8 / 1
8533	400	300	2	6	26,10	1-0-6 / 1
8534	500	300	2	6	31,87	1-0-6 / 1
8535	600	400	2	6	49,99	1-0-4 / 1

Tabla corte fruta y vegetales verde

Green cutting board
Planche à découper vert
Tagliere verde
Grün schneidebrett



REF.	W(mm)	L(mm)	ESPEJOR	TACOS	€	UE / MOQ
8536	GN 1/1	GN 1/1		6	36,07	1-0-5 / 1
8539	300	200		4	14,00	1-0-8 / 1
8540	400	300		6	26,22	1-0-6 / 1
8541	500	300		6	32,41	1-0-6 / 1
8542	600	400		6	50,98	1-0-4 / 1

Tabla corte carne cruda roja

Red cutting board 2
Planche à découper rouge 2
Tagliere rosso 2
Rot schneidebrett 2



REF.	W(mm)	L(mm)	ESPEJOR	TACOS	€	UE / MOQ
8543	GN 1/1	GN 1/1	2	6	36,07	1-0-5 / 1
8546	300	200	2	4	14,00	1-0-10 / 1
8547	400	300	2	6	26,22	1-0-6 / 1
8548	500	300	2	6	32,41	1-0-6 / 1
8549	600	400	2	6	50,98	1-0-4 / 1

Tabla corte carne cruda aves amarilla

Yellow cutting board
Planche à découper jaune
Tagliere giallo
Gelb schneidebrett



REF.	W(mm)	L(mm)	ESPEJOR	TACOS	€	UE / MOQ
8550	GN 1/1	GN 1/1	2	6	36,07	1-0-5 / 1
8553	300	200	2	4	14,00	1-0-10 / 1
8554	400	300	2	6	26,22	1-0-6 / 1
8555	500	300	2	6	32,41	1-0-6 / 1
8556	600	400	2	6	50,98	1-0-4 / 1

Tabla corte carnes cocidas marrón

Brown cutting board
Planche à découper marron
Tagliere marrone
Braun schneidebrett



REF.	W(mm)	L(mm)	ESPEJOR	TACOS	€	UE / MOQ
8557	GN 1/1	GN 1/1	2	6	36,07	1-0-5 / 1
8560	300	200	2	4	14,00	1-0-10 / 1
8561	400	300	2	6	26,22	1-0-6 / 1
8562	500	300	2	6	32,41	1-0-6 / 1
8563	600	400	2	6	50,98	1-0-4 / 1

Soporte inox para tablas

Cutting board support
Support planche à découper
Supporto tagliere
Schneidebretthalterung



REF.	W(mm)	L(mm)	H(mm)	€	UE / MOQ
11640	265	310	280	21,23	1-0-20 / 1

Rascador para tabla

Cutting board scraper
Brosse pour planche à découper
Spazzola per tagliere
Reinigungsbürste für schneidebrett



REF.	W(mm)	L(mm)	H(mm)	€	UE / MOQ
11761	60	170	90	39,40	1-0-36 / 1

Pack 6 tacos silicona

6 Pack rubber stoppers
Pack 6 tacos silicone
Confezione di 6 tacos in silicone
Pack 6 taco-ständer silikon



REF.	TACOS	€	UE / MOQ
11941	6	3,34	1-0-1000 / 1

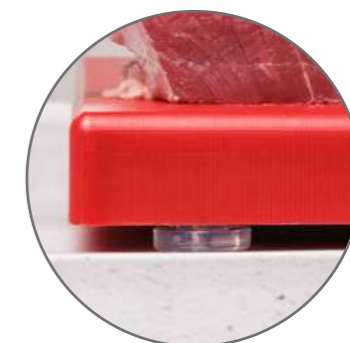



Madera de acacia de alta calidad.
High quality acacia wood.

Tratada con aceites naturales para resaltar su color y protegerla de la humedad.

Treated with natural oils to enhance its colour and protect it from moisture.

El patrón de bolques END GRAIN ofrece mayor resistencia al desgaste.

The END GRAIN bolt pattern offers greater wear resistance.



Hendiduras laterales para facilitar el agarre.

Side grooves for gripping and easy lifting.

Tacos de goma anti-deslizantes para mayor estabilidad.

Non-slip rubber pads on the corners for more stability.



Tabla madera acacia

Acacia cutting board
Planche à découper acacia
Tagliere acacia
Akazie schneidebrett

REF.	W(mm)	L(mm)	H(mm)	€	UE / MOQ
12034	400	320	38	56,38	1-0-0 / 1



Imán pared madera

Wooden wall magnet
Porte-couteaux magnetic
Barra magnetica legno
Magnetleiste für Messer Holz



REF.	L(mm)	H(mm)	€	UE / MOQ
8471	450	65	40,17	1-0-8 / 1



Imán pared inox

Magnetic bar inox
Porte-couteaux magnetic inox
Barra magnetica inox
Magnetleiste für Messer inox



REF.	L(mm)	H(mm)	€	UE / MOQ
8470	360	47	36,79	1-6-8 / 1



NEW

Expositor magnetico cuchillo

Magnetic knife holder
Support magnétique pour couteaux
Espositore magnetico per coltelli
Magnetischer Messerhalter



REF.	W(mm)	L(mm)	H(mm)	€	UE / MOQ
12182	120	60	75	22,31	1-0-10 / 1

* Para un uso optimo de este articulo, se recomienda usar cuchillos con una hoja inferior a los 20cm de largo.
For optimal use of this item, it is recommended to use knives with a blade length of less than 20 cm.



Imán pared PP

PP magnetic bar
Porte-couteaux magnetic PP
Barra magnetica PP
Magnetleiste für Messer PP



REF.	L(mm)	H(mm)	€	UE / MOQ
8472	555	50	13,70	1-6-12 / 1

Madera de acacia de alta calidad.

High quality acacia wood.

4 lados magnéticos.

4 magnetic sides.

Base de acero inoxidable con almohadillas antideslizantes.

Stainless steel base with non-slip pads.

Giratorio 360°

360° rotatable



Iman Taco Rotable Cuchillos

Rotating Magnet Knife Display
Aimant Taco Rotatif Pour Couteaux
Barra Magnetica Taco Rotabile Coltelli
Drehbarer Tischmagnet für Messer



REF.	W(mm)	L(mm)	H(mm)	€	UE / MOQ
11636	105	105	280	57,09	1-0-4 / 1



Iman Sobremesa Cuchillos

Tabletop Magnet Knife Display
Aimant De Table Pour Couteaux
Barra Magnetica Portacoltelli
Tischmagnet für Messer



REF.	W(mm)	L(mm)	H(mm)	€	UE / MOQ
11038	280	90	245	52,85	1-0-5 / 1



Expositor Madera Cuchillo Chef

Wooden Chef'S Knives Display
Présentoir En Bois Pour Couteau De Chef
Espositore In Legno Coltelli Chef
Messerhalter für Küchenmesser



REF.	W(mm)	L(mm)	H(mm)	€	UE / MOQ
11637	80	340	180	19,73	1-0-10 / 1

Ideal para mantener la piedra fija durante el proceso de afilado.

Ideal for holding the stone in place during the sharpening process.

Soporte de caucho ajustable a distintos tamaños de piedras.

Adjustable rubber support for different stone sizes.

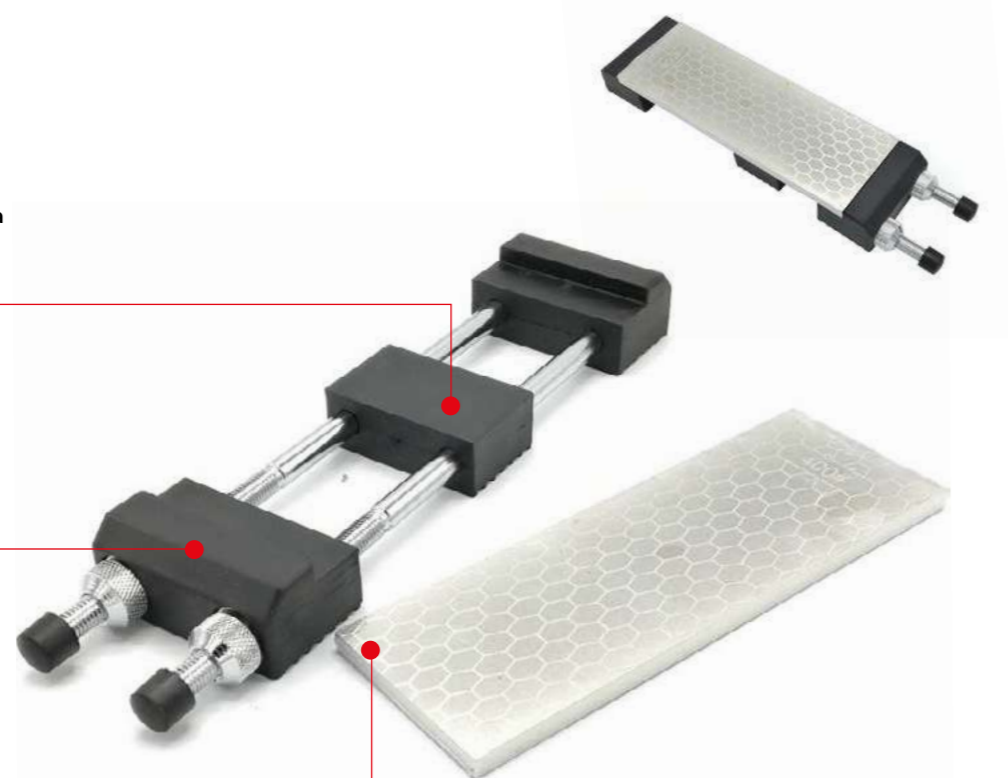

Placa diamantada de doble cara (grano 400 / 1000) y doble función: reparación de hojas dañadas y realizar un filo completamente nuevo. También la podemos usar para aplanar y limpiar las piedras de afilar usadas.

Double-sided diamond plate (grit 400 / 1000) with double function: repairing damaged blades and making a completely new cutting edge. It can also be used to flatten and clean used whetstones.

Placa diamantada para afilado con soporte

Diamond encrusted sharpening and levelling stone with stand
Plaque diamantée pour affûtage et aplatissage avec support
Piastra diamantata per affilare e appiattare con supporto
Diamantschleifstein mit Haltern

REF.	W(mm)	L(mm)	H(mm)	€	UE / MOQ
11939	286	70	30	42,84	1-0-10 / 1



Piedra afilar
Whetstone
Pierre à aiguiser
Cote
Schärfstein Messer

REF.	L(mm)	€	UE / MOQ
6958	180	30,54	1-0-16 / 1



Afilador mango
Two stage knife sharpener
Affûteur couteau
Arrotino
Messerschärfer mit Griff

REF.	W(mm)	€	UE / MOQ
6957	190	11,00	1-0-36 / 1



Puente bambú piedra afiladora

Bamboo sharpening stone
Pierre à aiguiser en bambou
Pietra per affilare in bambù
Schärfstein aus bambus

* No incluye
piedra de afilar
Sharpening stone
not includes

REF.	W(mm)	L(mm)	H(mm)	€	UE / MOQ
11029	100	430	90	58,32	1-0-0 / 1



Piedra de afilar 400

Sharpening stone 400
Pierre a aiguiser 400
Pietra per affilare 400
Schärfstein 400



REF.	W(mm)	L(mm)	H(mm)	€	UE / MOQ
11030	70	210	25	132,36	1-0-0 / 1



Piedra de afilar 1000

Sharpening stone 1000
Pierre a aiguiser 1000
Pietra per affilare 1000
Schärfstein 1000



REF.	W(mm)	L(mm)	H(mm)	€	UE / MOQ
11031	70	210	25	164,75	1-0-0 / 1



Piedra de afilar 3000

Sharpening stone 3000
Pierre a aiguiser 3000
Pietra per affilare 3000
Schärfstein 3000



REF.	W(mm)	L(mm)	H(mm)	€	UE / MOQ
11032	70	210	25	193,50	1-0-0 / 1



Piedra de afilar 5000

Sharpening stone 5000
Pierre a aiguiser 5000
Pietra per affilare 5000
Schärfstein 5000



REF.	W(mm)	L(mm)	H(mm)	€	UE / MOQ
11033	70	210	25	263,79	1-0-0 / 1

Placa acero diamantada

Diamond steel plate
Plaque en acier diamant
Piastra in acciaio diamantato
Diamant-stahlplatte



REF.	W(mm)	L(mm)	H(mm)	€	UE / MOQ
11034	203	76	10	155,71	1-0-0 / 1

El maletín es la mejor opción para mantener tus cuchillos organizados y con el filo protegido para un afilado duradero.

La manera más segura de transportar tu selección de cuchillos donde necesites.

The Knife roll is the best option to keep your knives organised and edge protected for long-lasting sharpness

The safest way to transport your knife selection wherever you need it.

2 cierres de plástico de alta seguridad

2 high-security plastic closures

Tela adicional con cremallera para proteger los cuchillos

The long cuffs provide extra protection for your forearms.

Bolsillos con banda elástica para sujetar los cuchillos con seguridad.

Pockets with elastic band to hold knives securely.

Asa de mano + tira ajustable para colgar para un transporte más práctico.

Hand grip handle + adjustable hanging strap for convenient carrying.

Bolsa Porta Cuchillos
Knife roll
Sac porte-couteaux
Borsa portacoltelli
Tragebeutel für messer

REF.	W(mm)	L(mm)	H(mm)	€	UE / MOQ
11035	210	520	55	71,25	1-0-10 / 1



Funda Protectora Abs

Abs protective sheath
Étui de protection abs
Custodia protettiva In plastica Schutzhülle abs

REF.	MEDIDAS / SIZES (mm)	€	UE / MOQ
11734	120 x 35 mm	4,45	1-30-240 / 1
11735	160 x 35 mm	4,60	1-30-240 / 1
11736	200 x 55 mm	5,23	1-30-240 / 1
11737	240 x 65 mm	5,91	1-30-240 / 1
11738	270 x 55 mm	5,86	1-30-240 / 1

Tejido de Nylon resistente que protege los cuchillos de golpes y evita pinchazos y cortes.

Durable nylon fabric protects knives from knocks and prevents punctures and cuts.

Incluye maletín con compartimentos específicos para utensilios de cocina.

Includes case with specific compartments for kitchen utensils.



Mochila chef con maletín portacuchillos

Chef backpack with knife holder case
Sac à dos de chef avec étui porte-couteaux
Zaino da chef con custodia portacoltelli
Kochrucksack mit Messerhalteretui

REF.	W(mm)	L(mm)	H(mm)	€	UE / MOQ
12022	140	320	460	154,42	1-0-6 / 1

Delantal cocina

Kitchen apron
Tablier de cuisine
Grembiule da cucina
Küchenschürze

REF.	L(mm)	W(mm)	€	UE / MOQ
12023	850	690	64,06	1-0-12 / 1





Regulador de grueso del corte.
Cutting thickness regulator.

Pies plegables y antideslizantes.
Foldable, non-slip feet.

SopORTE para sujeción de verduras y frutas con protección para los dedos.
Vegetable and fruit holder with finger protection.

CUCHILLA / BLADE: RODAJAS **CUCHILLA / BLADE: JULIANA 4MM** **CUCHILLA / BLADE: JULIANA 6MM** **CUCHILLA / BLADE: JULIANA 10MM** **CUCHILLA / BLADE: GOFRADO**



Mandolina Inox
Stainless Steel Mandoline
Mandoline Inox
Mandolina Inox
Edelstahl Mandoline

REF.	W(mm)	L(mm)	H(mm)	€	UE / MOQ
11748	123	395	42	83,67	1-0-6 / 1



PACKAGING BOX



Tijera profesional 8"
Scissors prof. Inox 8"
Ciseaux prof. Acier 8"
Forbice prof. Acciaio 8"
Stahl prof Schere 8"

REF.	L(mm)	€	UE / MOQ
5164	200	59,81	1-0-6 / 1



Tijera master 8"
Scissors master Inox 8"
Ciseaux pmaster Acier 8"
Forbice pmaster Acciaio 8"
Stahl master Schere 8"

REF.	L(mm)	€	UE / MOQ
5165	200	46,23	1-0-6 / 1



Tijera cocina inox
Kitchen scissors
Ciseaux de cuisine
Forbici cucina
Küchenschere

REF.	L(mm)	€	UE / MOQ
3910	220	29,03	1-12-48 / 1



Cascañueces
Nut cracker
Case-noix
Rompinoci
Nussknacker

REF.	L(mm)	€	UE / MOQ
3623	190	11,89	1-5-50 / 1



Tenedor marisco
Shellfish fork
Fourchette crustacé
Forchetta crostacei
Fischgabel

REF.	L(mm)	€	UE / MOQ
5099	220	2,92	0-12-120 / 12



Tijera para aves
Poultry shears
Coupe volailles
Trincipollo
Geflügelschere

REF.	L(mm)	€	UE / MOQ
8989	200	18,76	1-0-36 / 1



Tijera cocina 8,5
Kitchen scissors 8,5
Ciseaux cuisine 8,5
Forbice multiuso 8,5
Küchenschere 8,5

REF.	L(mm)	€	UE / MOQ
8988	210	7,59	1-12-96 / 1



Pinza rompe marisco
Lobster cracker
Pince homard
Pinza per aragosta
Hummerkuacker



REF.	L(mm)	€	UE / MOQ
0738	190	13,21	1-5-50 / 1



Pinza marisco
Shellfish cracker
Pince à fruits de mer
Pinza per frutti di mare
Schalentier-pinzette



REF.	L(mm)	€	UE / MOQ
11827	190	15,00	1-12-96 / 1



INOX
STAINLESS
STEEL
304

RUBBER



Rallador WIDE extra fino
St. Steel "wide" grater extra-thin
Râpe en inox coupe ultra fine
Grattugia taglio superfine
Breit rostfreie Reibe extra fein



REF.	L HOJA	L TOTAL	€	UE / MOQ
8946	135	320	7,70	1-6-96 / 6

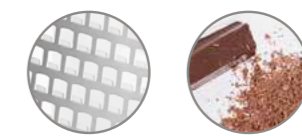

Rallador WIDE fino
St. Steel "wide" grater thin
Râpe en inox coupe fine
Grattugia taglio fine
Breit rostfreie Reibe fein



REF.	L HOJA	L TOTAL	€	UE / MOQ
8947	135	320	7,70	1-6-96 / 6



Rallador WIDE grueso
St. Steel "wide" grater extra coarse
Râpe en inox coupe épaisse
Grattugia taglio spesso
Breit rostfreie Reibe grob



REF.	L HOJA	L TOTAL	€	UE / MOQ
8948	135	320	7,70	1-6-96 / 6

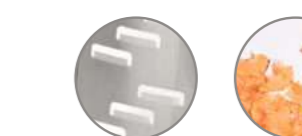

Rallador WIDE tiras largas
St. Steel "wide" grater large shaver
Râpe en inox coupe julienne
Grattugia taglio julienne
Breit rostfreie Reibe mit lange



REF.	L HOJA	L TOTAL	€	UE / MOQ
8949	135	320	7,89	1-6-96 / 6



Rallador SLIM fino
St. Steel lengthways grater thin
Râpe longue en inox coupe fine
Grattugia lunga taglio fine
Schmal rostfreie Reibe fein



REF.	L HOJA	L TOTAL	€	UE / MOQ
8950	220	410	7,89	1-6-96 / 6

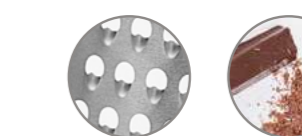

Rallador SLIM medio redondo
St. Steel lengthways grater medium
Râpe longue en inox coupe redondo moyen
Grattugia lunga taglio mezzo giro
Schmal rostfreie Reibe medium



REF.	L HOJA	L TOTAL	€	UE / MOQ
8951	220	410	7,89	1-6-96 / 6



Rallador SLIM grueso
St. Steel lengthways grater extra coarse
Râpe longue en inox coupe épaisse
Grattugia lunga taglio spesso
Schmal rostfreie Reibe grob



REF.	L HOJA	L TOTAL	€	UE / MOQ
8952	220	410	7,89	1-6-96 / 6



Rallador SLIM dual
St. Steel lengthways grater dual
Râpe longue en inox coupe dual
Grattugia lunga taglio dual
Duale schmal rostfreie Reibe



REF.	L HOJA	L TOTAL	€	UE / MOQ
8953	220	410	7,89	1-6-96 / 6

Se presenta con una funda de plástico para proteger la zona de corte
Comes with a plastic sheath to protect the cutting edge

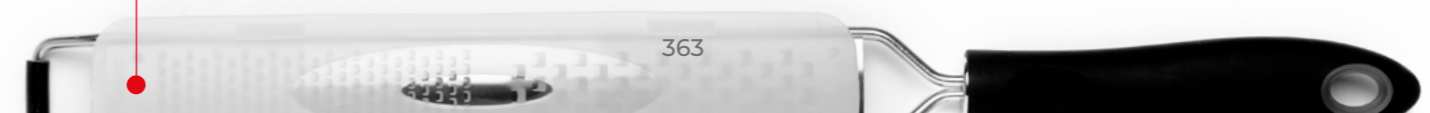

INOX
STAINLESS
STEEL
430

Rallador 4 caras HQ
4 side grater HQ
Rape 4 cotés HQ
Grattugia 4 facce HQ
Vierkantreibe HQ

REF.	H(mm)	€	UE / MOQ
7448	240	7,68	1-12-72 / 1

Mango ergonómico

Ergonomic handle

Acero inoxidable resistente al desgaste y la corrosión.

Wear and corrosion resistant stainless steel.



Grueso
Coarse



Fino
Fine

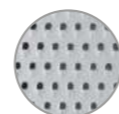

Medio
Medium



Rebanador
Slicer

INOX
STAINLESS
STEEL
201

Rallador 4 caras
4 side grater
Rape 4 cotés
Grattugia 4 facce
Vierkantreibe

REF.	H(mm)	€	UE / MOQ
1150	210	5,80	1-0-60t / 1



INOX
STAINLESS
STEEL
430

Pelapatatas
Potato-peeler
Économe acier inox
Pelapatate
Kartoffelschäler



REF.	L(mm)	€	UE / MOQ
3455	110	2,13	1-12-72 / 1



Abrelatas Inox
Stainless Steel Tin Opener
Ouvre-Boîte Inox
Apriscatole In Acciaio Inox
Dosenöffner Edelstahl

REF.	W(mm)	L(mm)	H(mm)	€	UE / MOQ
11818	45	65	28	3,02	1-0-96 / 1

Rasqueta plancha profesional 30cm
Professional scraper
Racleur professionnelle
Raschietti
Schaber glatt



REF.	L(mm)	€	UE / MOQ
8474	300	11,23	1-12-24 / 1

Recambio 10 cuchillas
Blister 10 blades
Blister 10 lames
Blister 10 lame
Blister 10 messer



REF.	€	UE / MOQ
8507	4,30	1-50-100 / 1

Rodillo de recambio
Wheel (spare part)
Rouleau (pièce de rechange)
Rullo
Austauschrad

REF.	€	UE / MOQ
8566	22,01	1-0-200 / 1

Cuchilla de recambio
Knife (spare part)
Couteau (pièce de rechange)
Lame
Austauschklinge

REF.	€	UE / MOQ
8565	8,25	1-0-200 / 1

Cepillo
Scraper
Brosse À Gratter
Raschietto
Schaber



REF.	W(mm)	L(mm)	H(mm)	€	UE / MOQ
11946	125	470	55	53,94	1-0-6 / 1

Recambio Cepillo
Replacement Scraper Brush
Pièce De Recharge Brosse À Gratter
Ricambio Spazzola Raschietto
Ersatzbürste Schaber

REF.	W(mm)	L(mm)	H(mm)	€	UE / MOQ
11947	70	125	17	12,47	1-0-24 / 1



Abrelatas industrial
Can opener
Ouvre-boîtes professionnel
Apriscatole
Industrieller edelstahl dosenöffner

REF.	H(mm)	€	UE / MOQ
8564	600	162,33	1-0-8 / 1



Pala repostería
Cake server
Pelle à gâteau
Spatola dolci
Kekss-Spachtel

REF.	W (mm)	€	UE / MOQ
8941	120	2,15	1-12-48 / 1



Espátula pastelera
Baker spatula
Palette
Spatola cuoco
Kuchenspachtel

REF.	SIZE	HOJA (mm)	€	UE / MOQ
8932	S	135	1,74	1-12-48 / 1
8933	M	225	1,96	1-12-48 / 1
8934	L	300	2,45	1-12-48 / 1



Paleta plancha triangular
Cleaning spatula
Palette triangle
Spatola triangolare
Dreieckige Bratenspachtel

REF.	SIZE	HOJA (mm)	€	UE / MOQ
8939	S	80	2,30	1-12-48 / 1
8940	L	100	2,38	1-12-48 / 1



Mango de polipropileno (PP) de forma redondeada para una sujeción más cómoda.

Rounded polypropylene (PP) handle for a more comfortable grip.

Alta resistencia a la corrosión.

Highly rust-resistant.

Pala fabricada en Acero inoxidable endurecido de alta calidad.

Spatula in high-quality hardened stainless steel.

Acabado satinado.

Satin finished.

Resistencia y flexibilidad para facilitar el trabajo en la cocina.

Hard-wearing and versatile round the kitchen.



Espátula flexible acodada
Angular spatula
Palette coudée
Spatola cuoco con scalino
Winkelpalette

REF.	SIZE	HOJA (mm)	€	UE / MOQ
8938	S	140	2,15	1-12-48 / 1
8937	L	200	2,38	1-12-48 / 1



Espátula plancha rectangular biselada
Solid, beveled turner
Palette pleine, biseautée
Spatola hamburger
Bratenspachtel Rechtechige

REF.	W (mm)	H (mm)	€	UE / MOQ
8935	80	120	2,90	1-12-48 / 1



Espátula pescado
Fish spatula
Spatule poisson
Pesce spatola
Fischpachtel

REF.	W (mm)	L (mm)	€	UE / MOQ
9996	80	290	2,45	1-12-48 / 1



Espátula angular emplatado
Angular spatula
Mini spatule
Spatola
Kleine Winhpalette

REF.	L (mm)	Paleta (mm)	€	UE / MOQ
8476	220	95	2,77	1-48-288 / 1



Molde redondo
Round ring
Moulage rond
Teglia tondo
Runcle Kochringe

REF.	Ø (mm)	H (mm)	€	UE / MOQ
7461	60	45	1,40	1-32-128 / 1
7462	70	45	1,40	1-32-128 / 1
7463	80	45	1,63	1-32-128 / 1
7464	90	45	1,75	1-32-128 / 1
7465	100	45	1,88	1-32-128 / 1
7466	120	45	2,00	1-32-128 / 1



REF.	SET	€	UE / MOQ
7449	PACK 6	10,50	1-24-48 / 1



Espátula pescado biselada
Fish turner
Palette poisson
Spatola pesce
Fischschaufel

REF.	W (mm)	H (mm)	€	UE / MOQ
8936	75	165	3,02	1-12-48 / 1



Mini lengua de silicona
Silicone spoon
Cuillère silicone
Spatola silicone
Silikonlöffel

REF.	L (mm)	COLOR	€	UE / MOQ
5161	170	ROJA	4,06	1-24-96 / 1



Molde cuadrado
Square ring
Moulage carre
Teglia quadrato
Quadratische Kochringe

REF.	W (mm)	L (mm)	H (mm)	€	UE / MOQ
7467	60	60	45	1,53	1-32-128 / 1
7468	70	70	45	1,75	1-32-128 / 1
7469	80	80	45	1,98	1-32-128 / 1
7470	90	90	45	2,23	1-32-128 / 1
7471	100	100	45	2,50	1-32-128 / 1
7472	120	120	45	2,33	1-32-128 / 1



REF.	SET	€	UE / MOQ
7450	PACK 6	12,75	1-24-48 / 1



Punta estriada para un mejor agarre de los alimentos

Grooved tip for a better grip of the foods.



Pinza chef recta
Straight chef tong
Pince chef droite
Pinze chef diritta
Pinzettenzange

INOX
STAINLESS
STEEL
430

REF.	L(mm)	€	UE / MOQ
7477	210	7,00	1-24-96 / 1
7478	300	5,00	1-24-96 / 1



Pinza chef precisión
Precision chef tong
Pince chef précision
Pinze chef precisione
Präzisions-Kochpinzette

INOX
STAINLESS
STEEL
430

REF.	L(mm)	€	UE / MOQ
7475	160	4,70	1-24-96 / 1
7476	240	5,70	1-24-96 / 1

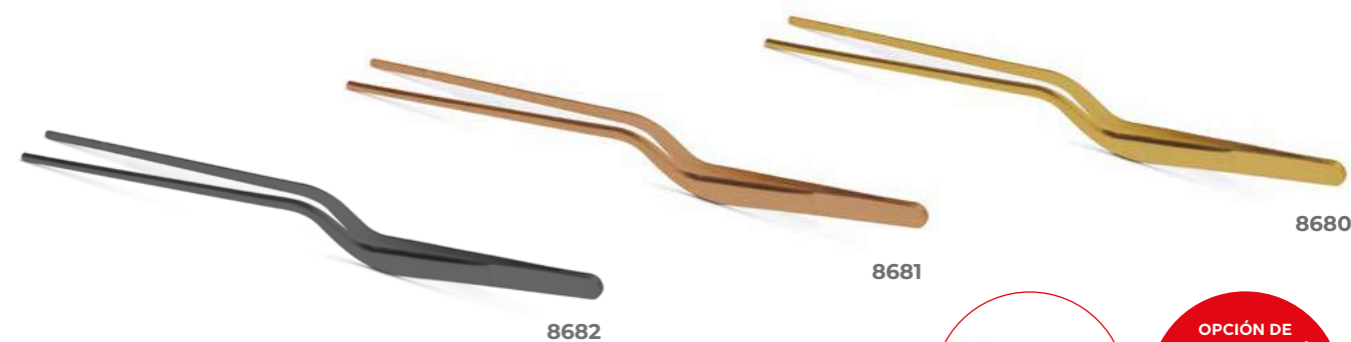

Pinza chef curva
Curved chef tong
Pince chef courbée
Pinze chef curve
Gebogene Pinzette

REF.	L(mm)	COLOR	€	UE / MOQ
7473	145	INOX	4,88	1-24-96 / 1
7474	200	INOX	5,13	1-24-96 / 1
8680	200	ORO	7,58	1-24-96 / 1
8681	200	COBRE	7,58	1-24-96 / 1
8682	200	NEGRO	7,58	1-24-96 / 1



OPCIÓN DE
PERSONALIZACIÓN
CON LASER.

LASER
PERSONALISATION
OPTION

INOX
STAINLESS
STEEL
430

Pinza quitaespinas
Fish bone tong
Pince à désarêter
Pinze lisca del pesce
Frischgräten pinzette

REF.	W(mm)	L(mm)	H(mm)	€	UE / MOQ
11819	19	135	20	3,25	1-0-72 / 1

Acabado brillo. Menos poroso, facilita la limpieza.

Mirror finish..
Less porous, easier to clean.

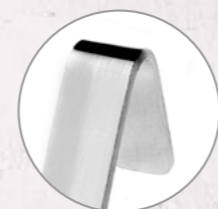

Mango con gancho para un fácil almacenamiento.

Hook handle for easy storage



Capacidad grabada en el mango.

Capacity engraved on the handle

Mango más grueso con nervio central que le proporciona más rigidez y resistencia.

Thicker handle with a central rib for more rigidity and stiffens and strengthens the handle.

INOX
STAINLESS
STEEL
201

Espumadera con malla
Mesh skimmer
Écumoire maillé
Schiumarola a rete passabrodo
Draht Schaumlöffel

REF.	L(mm)	€	UE / MOQ
9735	140	14,08	1-0-50 / 1
9736	160	15,79	1-0-30 / 1
9737	180	17,89	1-0-30 / 1
9738	200	19,73	1-0-30 / 1
9739	240	22,22	1-0-30 / 1

INOX
STAINLESS
STEEL
201

Cazo Monoblock
One piece laddle
Louche monoblock
Mestolo monoblock
Schöpfhelle monoblock

REF.	Ø(mm)	L(mm)	ml	€	UE / MOQ
9712	65	300	70	8,25	1-10-24 / 1
9713	80	320	125	9,45	1-6-60 / 1
9714	90	330	200	10,88	1-10-40 / 1
9715	100	370	250	12,33	1-10-40 / 1
9716	120	430	430	13,63	1-10-40 / 1
9717	140	440	650	16,00	1-10-40 / 1
9718	160	470	950	18,55	1-10-20 / 1

INOX
STAINLESS
STEEL
201

Cuchara servir monoblock
One piece spoon
Coulliere monoblock
Cucchiaio monoblock
Servierlöffel

REF.	L(mm)	€	UE / MOQ
9726	330	10,00	1-10-60 / 1

INOX
STAINLESS
STEEL
201

Tenedor 2 púas monoblock
One piece meat fork
Fourchette monoblock
Forchetta monoblock
Fleischgabel monoblock

REF.	L(mm)	€	UE / MOQ
9728	520	9,85	1-20-60 / 1

INOX
STAINLESS
STEEL
201

Araña
Tinned skimer
Escumoire etamée
Schiumarola filo
Fritierlöffel

REF.	L(mm)	€	UE / MOQ
9729	140	9,84	1-0-50 / 1
9730	160	10,25	1-0-25 / 1
9731	180	11,02	1-0-25 / 1
9732	200	11,67	1-0-25 / 1
9733	220	12,80	1-0-25 / 1
9734	240	13,92	1-0-25 / 1

INOX
STAINLESS
STEEL
201

Espumadera Monoblock
One piece skimmer
Écumoire monoblock
Schiumarola monoblock
Schäumerlöffel

REF.	Ø(mm)	L(mm)	€	UE / MOQ
9719	80	290	6,88	1-10-60 / 1
9720	100	320	7,95	1-10-60 / 1
9721	120	350	9,83	1-10-40 / 1
9722	140	380	12,88	1-10-40 / 1
9723	160	410	15,33	1-10-40 / 1
9724	180	430	21,05	1-10-40 / 1
9725	200	450	24,99	1-10-40 / 1

INOX
STAINLESS
STEEL
201

Espátula perforada
Perforated spatula
Spatule perforée
Spatola forata
Pfanneschaufel perforiert

REF.	L(mm)	€	UE / MOQ
9727	350	12,10	1-12-48 / 1



Nylon
Fibra de alta calidad.
Poca porosidad mayor dureza.

Nylon
High-quality fibres.
Non-porous, more hard-wearing.

BPA FREE
BPA FREE

Alta resistencia térmica.
Soportan temperatura de hasta 220°C

Strong heat-resistance.
For use in temperatures up to 220 °C

No raya.
Suavidad con las superficies antiadherentes

Non-scratching.
Delicate on non-stick surfaces

Gancho que permite colgar para un práctico almacenaje.

Hanging for convenient storage.



REF.	Descripción	Lmm	Ømm	ml	€	UE/MOQ
A 11809	Cuchara Nylon Spoon, Cuillère, Cucchiaio, Löffel	49			14,69	1-0-75 / 1
B 11810	Cucharón Nylon 10 Spoon, Louche, Mestolo, Schöpflöffel	48	Ø 100	200ml	14,97	1-0-50 / 1
11811	Cucharón Nylon 12 Spoon, Louche Mestolo, Schöpflöffel	50	Ø 120	350ml	16,85	1-0-75 / 1
11812	Cucharón Nylon 14 Spoon, Louche, Mestolo, Schöpflöffel	51	Ø 140	500ml	17,91	1-0-50 / 1
C 11813	Espátula Nylon Perforada Slotted, Spatula, Spatule Perforé, Spatola Forata, Schanfel Perforiert	51			16,85	1-0-75 / 1
D 11814	Espátula Nylon Sin Agujeros Spatula W/O, Spatule Sans Trou, Spatola Senza Buchi, Pfannenwender Ohne Löcher	51			16,85	1-0-75 / 1
E 11815	Espumadera Nylon 10 Skimmer, Écumoire, Schiumarola, Schaumlöffel	44	Ø 100		14,97	1-0-75 / 1
11816	Espumadera Nylon 12 Skimmer, Écumoire, Schiumarola, Schaumlöffel	45	Ø 120		16,85	1-0-75 / 1
11817	Espumadera Nylon 14 Skimmer, Écumoire, Schiumarola, Schaumlöffel	47	Ø 140		17,91	1-0-75 / 1



Muesca antivuelco
No tipping

REF.	Descripción	Lmm	€	UE/MOQ
A 8405	Cuchara Spaguetti Spaguetti Server, Cuillère Spaguetti, Servispaguetti, Spaguettilöffel	325	4,70	1-0-12 / 1
B 8407	Pinza Cocina Kitchen Pincers, Pince, Pinza Cucina, Zange	310	4,51	1-0-12 / 1
C 8398	Cazo Ladle, Louche, Mestolo, Schöoflöffel	330	5,46	1-0-24 / 1
D 8400	Espátula Perforada Slotted Spatula, Spatule Perforé, Spatola Forata, Pfannenwender Mit Schlitzen	345	4,08	1-0-12 / 1
E 8399	Espumadera Skimmer Écumoire Schiumarola Schaumlöffel	335	4,61	1-0-12 / 1
F 8402	Pala Lasaña Lasagna Shovel, Palette À Lasagne, Pala Lasagna, Lasagneheber	290	4,32	1-0-12 / 1
G 8404	Pala Freir	290	4,57	1-0-12 / 1
H 8403	Cuchara Servir Rice Shovel, Cuillère De Service, Cucchiaione Riso, Servierlöffel	285	4,13	1-0-12 / 1
I 8406	Espátula Crepes Crepes Spatula, Palette, Spatola Creppes, Kuchenheber	335	4,01	1-0-12 / 1
J 8401	Paleta Pescado Universal Shovel, Pelle À Poison, Pala Multiuso, Fischheber	335	4,10	1-0-12 / 1

INOX
STAINLESS
STEEL
304MEDIDA MALLA
MESH SIZE:
1,5 x 1 mm

Cedazo Velo
Sieve velo
Tamis velo
Setaccio velo
Mehlsieb

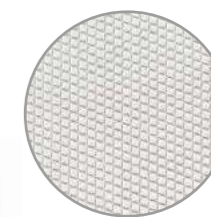

REF.	Ø(mm)	€	UE / MOQ
10650	250	13,87	1-6-12 / 1
10651	300	17,38	1-6-12 / 1
10652	350	21,92	1-4-8 / 1

INOX
STAINLESS
STEEL
304MEDIDA MALLA
MESH SIZE:
2,5 x 1,4 mm

Cedazo Harina
Flour sieve
Tamis farine
Setaccio farina
Mehlsieb

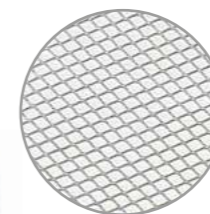

REF.	Ø(mm)	€	UE / MOQ
10653	250	13,87	1-6-12 / 1
10654	300	17,38	1-6-12 / 1
10655	350	21,92	1-4-8 / 1

INOX
STAINLESS
STEEL
304MEDIDA MALLA
MESH SIZE:
4 x 3 mm

Cedazo Pan
Bread Sieve
Tamis pain
Setaccio pane
Brotsieb



REF.	Ø(mm)	€	UE / MOQ
10656	300	17,38	1-6-12 / 1
10657	350	21,92	1-4-8 / 1

INOX
STAINLESS
STEEL
304MEDIDA MALLA
MESH SIZE:
11 x 9 mm

Cedazo Pescado
Fish sieve
Tamis poisson
Setaccio peixe
Fischsieb



REF.	Ø(mm)	€	UE / MOQ
10658	300	17,38	1-6-12 / 1
10659	350	21,92	1-4-8 / 1

Colador Chino Piston
Piston Funnel
Passoire Chinois Piston
Colino Chineso A Pistone
Passiersieb



REF.	W(mm)	L(mm)	H(mm)	€	UE / MOQ
11777	200	280	240	61,17	1-0-8 / 1

INOX
STAINLESS
STEEL
201

Colador Malla
Mesh Sieve
Passoire Maille
Colino A Maglia
Küchensieb



REF.	Ø(mm)	H(mm)	€	UE / MOQ
11950	200	220	19,41	1-0-6 / 1
11949	250	270	24,60	1-0-6 / 1

INOX
STAINLESS
STEEL
201

Colador chino con clip
Conical soup strainer with clip
Passoire chinois
Cornetto cinese
Spitzsieb



REF.	Ø(mm)	€	UE / MOQ
9764	160	4,35	1-0-60 / 1
9765	180	5,67	1-0-60 / 1
9766	200	6,34	1-0-60 / 1
9767	220	7,22	1-0-60 / 1
9768	240	7,98	1-0-30 / 1
9769	260	8,86	1-0-30 / 1

INOX
STAINLESS
STEEL
201

Colador fino
Oil strainer
Passoire à huile
Colino per l'olio
Ölsieb



REF.	Ø(mm)	€	UE / MOQ
2884	80	2,12	1-0-24 / 1
2885	100	2,58	1-0-24 / 1
2886	120	3,20	1-0-24 / 1
2887	140	3,59	1-0-24 / 1
2888	160	3,73	1-0-24 / 1
2889	180	4,63	1-0-24 / 1
2890	200	5,13	1-0-24 / 1

CORTE / CUT

INOX STAINLESS STEEL 201



Barra de comandas
Order rack
Porte-fiches à billes
Asta portascotrini
Zettelfeiste

REF.	W(mm)	L(mm)	H(mm)	€	UE / MOQ
9760	24	615	24	13,02	1-6-24 / 1
11776	58	1000	22	21,49	1-0-24 / 1

INOX STAINLESS STEEL 304



Escurre fritos y carr
Fry colander
Passoire à frites
Cesta per friggere
Frittensieb

REF.	W(mm)	L(mm)	€	UE / MOQ
8381	290	400	157,17	1-0-6 / 1
8382	390	500	193,77	1-0-4 / 1
8383	390	600	220,60	1-0-3 / 1

INOX STAINLESS STEEL 201



Rustidera
Lasagna pan
Plat à rôtir
Rostiera
Lasagneform

REF.	W(mm)	L(mm)	H(mm)	€	UE / MOQ
1422	250	180	40	10,25	1-0-24 / 1
1421	300	220	50	13,92	1-0-12 / 1
1420	350	260	50	18,53	1-0-12 / 1
1419	400	300	60	22,51	1-0-12 / 1
5282	450	320	65	29,05	1-0-4 / 1
5283	500	360	70	38,22	1-0-4 / 1
5284	600	400	75	50,11	1-0-4 / 1

INOX STAINLESS STEEL 201



Flanera profesional
Pudding mould
Moule à flan
Crème caramel
Becherförmchen

REF.	Ø(mm)	H(mm)	€	UE / MOQ
9632	75	50	2,71	1-12-120 / 1
9633	85	55	4,06	1-12-120 / 1

INOX STAINLESS STEEL 201



Espolvoreador 3 posiciones
Stainless steel sprinkler 3p
Saupoudreuse acier 3p
Draga acciaio 3p
Strendose 3 pos.

REF.	H(mm)	€	UE / MOQ
8794	110	5,42	1-1-100 / 1

INOX STAINLESS STEEL 304

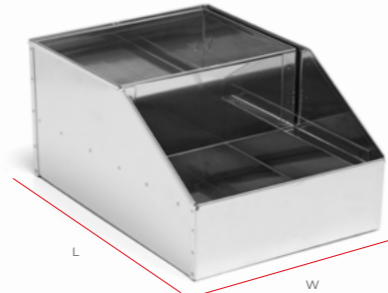

Harinero
Flour bin
Tamis à farine inox
Farinheiro
Mehlsieb

REF.	W(mm)	L(mm)	H(mm)	€	UE / MOQ
8384	265	370	180	134,36	1-0-1 / 1
8385	265	500	180	156,36	1-0-1 / 1
8386	330	500	180	169,71	1-0-1 / 1

INOX STAINLESS STEEL 201



Pinza para rustidera
Lasagna pan tong
Pince plat à rôtir
Molla forno
Ofenzange

REF.	L(mm)	€	UE / MOQ
5656	185	4,50	1-10-100 / 1

INOX STAINLESS STEEL 201



Bol semiesférico
Mixing bowl
Bassine hémispherique
Bastardella semisferica
Schneeschlagkessel

REF.	Ø(mm)	€	UE / MOQ
9748	160	2,25	1-0-100 / 1
9749	220	4,17	1-0-50 / 1
9750	240	4,99	1-0-50 / 1
9751	300	8,34	1-0-50 / 1
9752	340	10,57	1-0-25 / 1
9753	360	11,33	1-0-25 / 1
9754	400	15,51	1-0-25 / 1



Triple boquilla:
ideal para decoraciones.
Triple nozzle:
great for decorations.



Biberón triple
Triple squeeze bottle
Triple distributeur
Garrafa com boquilha triplo
Dosierflasche mit Dreifachdüse

REF.	ml	H(mm)	€	UE / MOQ
8449	360	180	2,14	1-4-24 / 1
8450	720	245	2,51	1-4-24 / 1



Todos los biberones tienen marcas de medición en milímetros.
All bottles have measurement marks in millimeters.

PP POLYPROPYLENE



Jarra medidora
Measuring PP jug
Pichet gradué PP
Caraffa graduata
Messbecher

REF.	H(mm)	ml	€	UE / MOQ
8451	133	500	2,29	1-12-72 / 1
8452	160	1.000	2,79	1-6-6 / 1
8453	215	2.000	4,00	1-6-60 / 1

SILICONE



Cuchara silicona
Silicon spoon
Cuillère silicone
Cucchiaio silicone
Silikonlöffel

REF.	L(mm)	€	UE / MOQ
8484	250	4,40	1-12-7 / 1
8485	350	5,37	1-12-72 / 1
8486	400	6,12	1-12-72 / 1



Todos los biberones tienen marcas de medición en milímetros.
All bottles have measurement marks in millimeters.



Biberón transparente
Clear squeeze bottles
Distributeur à pression transparent
Garrafa trasparente
Dosierflasche transparent

REF.	ml	H(mm)	€	UE / MOQ
8445	240	190	1,61	1-4-24 / 1
8446	360	220	1,79	1-4-24 / 1
8447	720	260	2,09	1-4-24 / 1
8448	1.000	310	3,72	1-4-24 / 1

INOX STAINLESS STEEL 430

NYLON



Batidor 8 varillas Nylon
Whisk 8 wires
Fouet 8 fils
Frusta 8 fili
Rührbesen 8 Drähte

REF.	L(mm)	VARILLAS(mm)	€	UE / MOQ
8480	250	12	8,31	1-12-48 / 1
8481	300	170	9,48	1-12-48 / 1
8482	350	220	11,23	1-12-48 / 1
8483	400	250	11,96	1-6-24 / 1

SILICONE



Espátula silicona
Silicon spatula
Spatule silicone
Spatola silicone
Silikonspachtel

REF.	L(mm)	€	UE / MOQ
8487	250	4,40	1-12-72 / 1
8488	350	5,37	1-12-72 / 1
8489	400	6,12	1-12-72 / 1



Tamaños GN / GN Sizes:

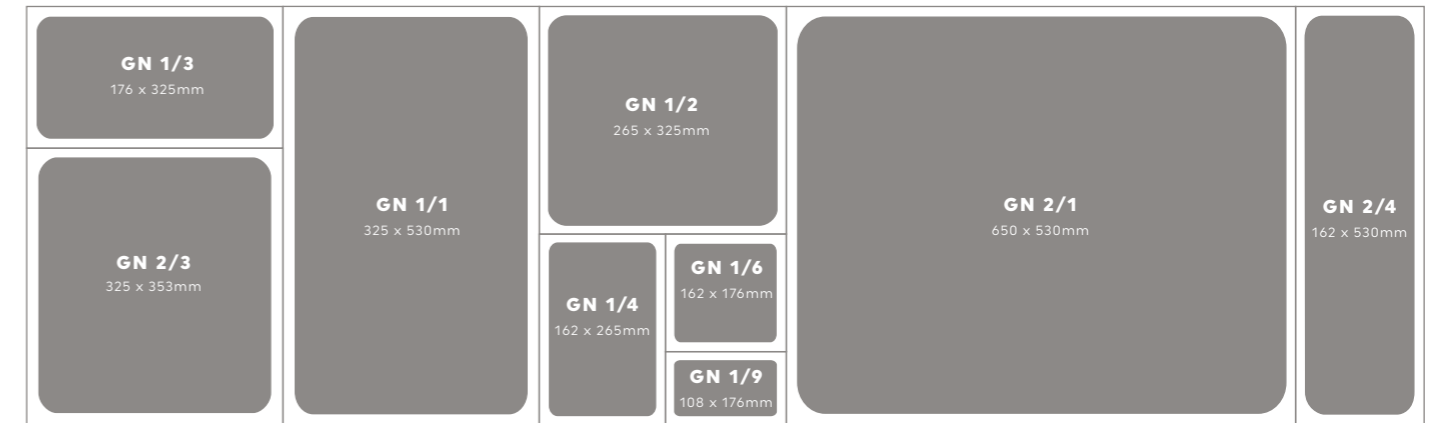

*medidas exteriores / external dimensions

Altura GN / GN High:



**Certificado
contacto
alimentario.**



Alta calidad garantizada.
High quality guaranteed.

Nuestras cubetas GN de acero AISI 304 son compatibles con las principales marcas GASTRONORM.



Resistencia a la corrosión.
Corrosion resistance.

El radio de las esquinas más abierto permite una mejor y más fácil apilabilidad y optimiza la capacidad de las cubetas.

Our AISI 304 steel GN trays are compatible with the main GASTRONORM brands.



Máxima capacidad.
Maximum capacity.

The more open corner radius allows for better and easier stackability and optimises the capacity of the trays.



Apto horno.
Oven save.



Apto lavavajillas.
Dishwasher save.



Apilable.
Stackable.



-20°C
300 °C



**Apto contacto
alimentario.**
Food contact save.



Apto horno.
Oven save.



Apto lavavajillas.
Dishwasher save.



Apilable.
Stackable.



-20°C
300°C



Apto contacto
alimentario.
Food contact save.

COMPATIBLE CON
LAS PRINCIPALES
MARCAS DEL
MERCADO

COMPATIBLE WITH
THE MAIN BRANDS
ON THE MARKET

El radio de las esquinas más abierto permite una mejor y más fácil apilabilidad y optimiza la capacidad de las cubetas.

The more open corner radius allows for better and easier stackability and optimises the capacity of the trays.

GN 1/1 - 325 X 530 mm



REF.	H(mm)	e(mm)	LITROS	€	UE / MOQ
10147	20	0,7		18,10	1-0-6 / 1
10148	40	0,7		21,27	1-0-6 / 1
10149	55	0,7		24,25	1-0-6 / 1
10150	65	0,8	8,8	18,10	1-0-6 / 1
11089	65	0,7	8,8	22,42	1-0-6 / 1
10151	100	0,7	13,7	31,22	1-0-6 / 1
10153	150	0,7	20	41,13	1-0-6 / 1
10154	200	0,7	27,8	48,69	1-0-6 / 1

GN 1/2 - 265 X 325 mm



REF.	H(mm)	e(mm)	LITROS	€	UE / MOQ
10164	20	0,7		9,69	1-0-6 / 1
10166	40	0,7		11,82	1-0-6 / 1
10168	65	0,7	8,8	14,46	1-0-6 / 1
10170	100	0,7	13,7	19,43	1-0-6 / 1
10172	150	0,7	20	25,90	1-0-6 / 1
10173	200	0,7	27,8	36,96	1-0-6 / 1

GN 1/3 - 176 X 325 mm



REF.	H(mm)	e(mm)	LITROS	€	UE / MOQ
10179	20	0,7		7,37	1-6-18 / 1
10181	40	0,7		9,64	1-6-18 / 1
11905	55	0,7		11,13	1-6-18 / 1
10183	65	0,7	2,4	11,34	1-6-18 / 1
10185	100	0,7	3,5	14,37	1-6-18 / 1
10187	150	0,7	5,4	22,59	1-6-18 / 1
10188	200	0,7	7,2	32,38	1-0-6 / 1

GN 1/4 - 162 X 265 mm



REF.	H(mm)	e(mm)	LITROS	€	UE / MOQ
10190	20	0,7		6,29	1-6-24 / 1
10432	40	0,7		7,85	1-6-24 / 1
10192	65	0,7	1,7	9,59	1-6-24 / 1
10194	100	0,7	2,5	12,81	1-6-24 / 1
10195	150	0,7	3,8	18,76	1-6-24 / 1
10196	200	0,7	4,8	29,86	1-6-24 / 1



GN 1/6 - 162 X 176 mm



REF.	H(mm)	e(mm)	LITROS	€	UE / MOQ
10197	65	0,7	1	7,33	1-6-36 / 1
10199	100	0,7	1,5	9,69	1-6-36 / 1
10200	150	0,7	2,3	13,61	1-6-36 / 1
10201	200	0,7	3,3	24,10	1-6-36 / 1



GN 1/9 - 108 X 176 mm



REF.	H(mm)	e(mm)	LITROS	€	UE / MOQ
10203	65	0,7	0,6	5,67	1-6-48 / 1
10205	100	0,7	0,8	8,46	1-6-48 / 1

GN 2/1 - 650 X 530 mm



REF.	H(mm)	e(mm)	LITROS	€	UE / MOQ
10141	20	0,8		44,58	1-0-6 / 1
10142	40	0,8		46,51	1-0-6 / 1
10143	65	0,8	8,8	49,06	1-0-6 / 1
10144	100	0,8	13,7	63,20	1-0-6 / 1
10145	150	0,8	20	94,55	1-0-6 / 1
10146	200	0,8	27,8	107,19	1-0-6 / 1

GN 2/4 - 162 X 530 mm



REF.	H(mm)	e(mm)	LITROS	€	UE / MOQ
10175	65	0,7	0,7	25,53	1-6-24 / 6
10176	100	0,7	0,7	33,93	1-6-24 / 6
10177	150	0,7	0,8	43,27	1-6-24 / 6

GN 2/3 - 325 X 353 mm



REF.	H(mm)	e(mm)	LITROS	€	UE / MOQ
10155	20	0,7	0,7	16,40	1-6-24 / 1
10157	40	0,7	0,7	17,35	1-6-24 / 1
10159	65	0,7	0,8	20,46	1-6-24 / 1
10160	100	0,7		27,50	1-6-24 / 1
10161	150	0,7		40,43	1-6-24 / 1
10162	200	0,7		55,54	1-6-24 / 1

Fondo perforado
Perforated bottom
Egouttoirs pour bacs
Falso fondo forato
Abtropfgitter



Perfil divisorio gastronorm
Adaptable bars
Barrettes de composition
Separatore
Adapter



REF.	W(mm)	L(mm)	e (mm)	LITROS	€	UE / MOQ
10206	470	590	0,7	GN 2/1	56,07	6
10207	469	269	0,7	GN 1/1	21,84	10
10209	271	211	0,7	GN 1/2	21,59	1
10210	266	116	0,7	GN 1/3	19,63	1
10211	118	106	0,7	GN 1/6	13,30	1

REF.	SIZE	e (mm)	€	UE / MOQ
10212	GN 1/1	0,7	7,51	1
10213	GN 1/2	0,7	4,73	1

GN 1/1 Perforada - Perforated - Perforé - Forate - Perforiert - **325 X 530 mm**



REF.	H _(mm)	e _(mm)	LITROS	€	UE / MOQ
10220	20	0,7		21,17	1-0-6 / 1
10221	40	0,7		24,34	1-0-6 / 1
10222	55	0,7		32,92	1-0-6 / 1
10223	65	0,7	8,8	27,32	1-0-6 / 1
10224	100	0,7	13,7	33,13	1-0-6 / 1
10225	150	0,7	20	42,68	1-0-6 / 1
10226	200	0,7	27,8	58,75	1-0-6 / 1

GN 1/2 Perforada - Perforated - Perforé - Forate - Perforier - **265 X 325 mm**



REF.	H _(mm)	e _(mm)	LITROS	€	UE / MOQ
10234	65	0,7	8,8	16,83	1-0-6 / 1
10235	100	0,7	13,7	21,79	1-0-6 / 1
10236	150	0,7	20	28,26	1-0-6 / 1
10237	200	0,7	27,8	39,32	1-0-6 / 1

GN 1/3 Perforada - Perforated - Perforé - Forate - Perforier - **176 X 325 mm**



REF.	H _(mm)	e _(mm)	LITROS	€	UE / MOQ
10238	40	0,7		12,00	1-6-18 / 6
10239	65	0,7	2,4	13,71	1-6-18 / 6
10240	100	0,7	3,5	16,73	1-6-18 / 6
10241	150	0,7	5,4	24,95	1-6-18 / 6
10242	200	0,7	7,2	34,74	1-6-18 / 6

GN 2/1 Perforada - Perforated - Perforé - Forate - Perforier - **650 X 530 mm**



REF.	H _(mm)	e _(mm)	LITROS	€	UE / MOQ
10214	20	0,8		56,66	1-6-24 / 1
10215	40	0,8		58,62	1-6-24 / 1
10216	65	0,8	1,7	70,39	1-6-24 / 1
10217	100	0,8	2,5	88,67	1-6-24 / 1
10218	150	0,8	3,8	129,27	1-6-24 / 1
10219	200	0,8	4,8	147,56	1-6-24 / 1

GN 2/3 Perforada - Perforated - Perforé - Forate - Perforier - **325 X 353 mm**



REF.	H _(mm)	e _(mm)	LITROS	€	UE / MOQ
10227	20	0,7		18,87	1-6-24 / 1
10228	40	0,7		22,28	1-6-24 / 1
10230	65	0,7	1,7	24,63	1-6-24 / 1
10231	100	0,7	2,5	35,16	1-6-24 / 1
10232	150	0,7	3,8	57,09	1-6-24 / 1
10233	200	0,7	4,8	66,98	1-6-24 / 1



Apto para horno.
Oven save.

CUBETAS INOX AISI 304 - 18/10
STAINLESS STEEL 304 - 18/10 CONTAINERS

Tapa GN

GN Lid - Couvercle GN - Coperchio GN - GN-deckel - **162 X 176 mm**



REF.	GN	e _(mm)	€	UE / MOQ
11912	2/1	0,8	32,46	1-0-6 / 6
10245	2/3	0,7	18,72	1-0-6 / 6
10243	1/1	0,7	18,15	1-0-6 / 6
10247	1/2	0,7	10,02	1-0-6 / 6
10249	1/3	0,7	7,80	1-0-6 / 6
10251	1/4	0,7	6,62	1-0-6 / 6
10253	1/6	0,7	4,54	1-0-6 / 6
10255	1/9	0,7	3,54	1-0-6 / 6

Tapa GN cierre hermético

GN hermetic lid - Couvercle étanche GN - Coperchio ermetico GN - GN-steck-deckell



REF.	GN	e _(mm)	€	UE / MOQ
10258	1/1	0,7	36,58	1-0-6 / 1
10259	1/2	0,7	25,59	1-0-6 / 1
10260	1/3	0,7	21,90	1-0-6 / 1
10261	1/4	0,7	19,09	1-0-6 / 1
10262	1/6	0,7	14,91	1-0-6 / 1

Tapa GN orificio asas

GN lid with hole for handles - Couvercle GN avec trou pour poignées - Coperchio GN con foro per maniglie - GN-deckel Lock für Griffe



REF.	GN	e _(mm)	€	UE / MOQ
10263	1/1	0,7	17,97	1-0-6 / 1
10265	1/2	0,7	10,29	1-6-12 / 1
10266	1/3	0,7	8,22	1-6-18 / 1
10267	1/4	0,7	7,13	1-6-24 / 1
10268	1/6	0,7	5,15	1-6-36 / 1
10264	2/3	0,7	20,18	1-6-12 / 1

Tapa GN orificio cucharón

GN lid with ladle hole - Couvercle GN avec trou pour louche - Coperchio GN con foro mestolo - GN-deckel loch kelle 1/1



REF.	GN	e _(mm)	€	UE / MOQ
10269	1/1	0,7	17,56	1-0-6 / 1
10270	1/2	0,7	9,89	1-6-12 / 1
10271	1/3	0,7	7,81	1-6-18 / 1
10272	1/4	0,7	6,68	1-6-24 / 1
10273	1/6	0,7	4,74	1-6-36 / 1

Tapa GN sin asa

GN flat lid without handle - Couvercle plat GN sans poignée - Coperchio piatto GN senza manico - GN-Flachdeckel ohne Griff



REF.	GN	e _(mm)	€	UE / MOQ
10256	1/1	0,7	21,97	1-0-6 / 1
10257	1/2	0,7	12,69	1-0-6 / 1



Apto horno.
Oven save.



Apto lavavajillas.
Dishwasher save.



Apilable.
Stackable.



-20°C
300 °C



Apto contacto
alimentario.
Food contact save.

COMPATIBLE CON
LAS PRINCIPALES
MARCAS DEL
MERCADO

COMPATIBLE WITH ALL
MAJOR BRANDS ON THE
MARKET



USO
RECOMENDADO
EN BUFFET

RECOMMENDED
BUFFET USE



Medida estampada en la esquina

Measurement stamped on the corner

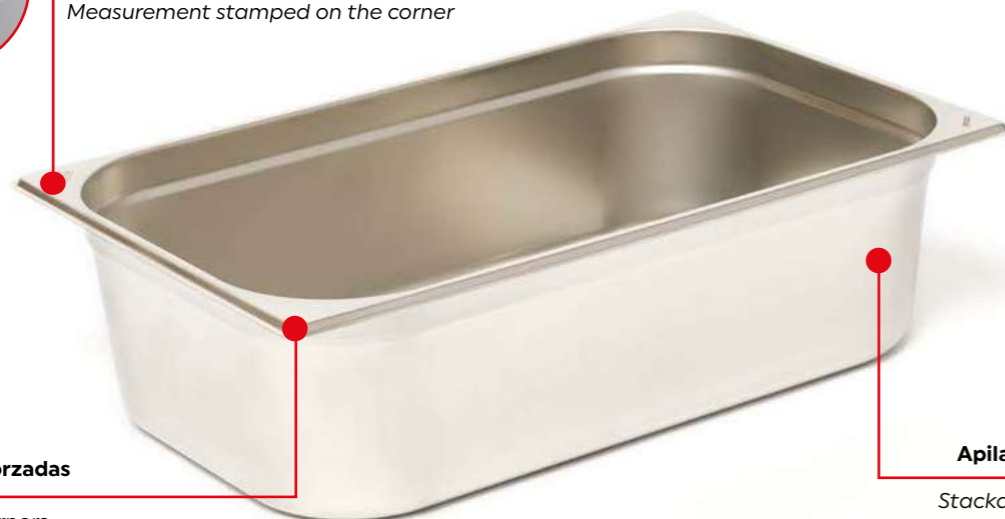

Esquinas reforzadas

reinforced corners

Apilable

Stackable



Modelo perforado perfecto para el
drenaje de líquidos y cocción al va-
por.

Perforated model perfect for drain-
ing liquids and steaming.

GN 1/1 - 325 X 530 mm



REF.	H(mm)	e(mm)	LITROS	€	UE / MOQ
10566	20	0,7		11,97	1-0-6 / 1
10567	40	0,7		13,81	1-0-6 / 1
10568	55	0,7		17,10	1-0-6 / 1
10569	65	0,8	8,8	16,10	1-0-6 / 1
10839	65	0,7	8,8	11,78	1-0-6 / 1
10570	100	0,7	13,7	21,05	1-0-6 / 1
10571	150	0,7	20	31,57	1-0-6 / 1
10572	200	0,7	27,8	38,67	1-0-6 / 1

GN 1/2 - 265 X 325 mm



REF.	H(mm)	e(mm)	LITROS	€	UE / MOQ
10573	20	0,7		5,92	1-6-12 / 1
10574	40	0,7		8,16	1-6-12 / 1
10575	65	0,7	4	9,47	1-6-12 / 1
10576	100	0,7	6,1	12,89	1-6-12 / 1
10577	150	0,7	9,2	19,89	1-6-12 / 1
10578	200	0,7	12	24,07	1-6-12 / 1

GN 1/3 - 176 X 325 mm



REF.	H(mm)	e(mm)	LITROS	€	UE / MOQ
10579	20	0,7		4,95	1-6-18 / 1
10580	40	0,7		6,97	1-6-18 / 1
10581	65	0,7	2,4	7,23	1-6-18 / 1
10582	100	0,7	3,5	10,13	1-6-18 / 1
10583	150	0,7	5,4	13,81	1-6-18 / 1
10584	200	0,7	7,2	18,28	1-6-18 / 1

GN 1/4 - 162 X 265 mm



REF.	H(mm)	e(mm)	LITROS	€	UE / MOQ
10585	20	0,7		4,87	1-6-24 / 1
10586	40	0,7		6,69	1-6-24 / 1
10587	65	0,7	1,7	6,55	1-6-24 / 1
10588	100	0,7	2,5	8,76	1-6-24 / 1
10589	150	0,7	3,8	13,39	1-6-24 / 1
10590	200	0,7	4,8	15,90	1-6-24 / 1



Certificado
contacto
alimentario.



-20°C
300 °C

GN 1/6 - 162 X 176 mm



REF.	H(mm)	e(mm)	LITROS	€	UE / MOQ
10591	65	0,7	1	4,83	1-6-36 / 1
10592	100	0,7	1,5	7,13	1-6-36 / 1
10593	150	0,7	2,3	10,54	1-6-36 / 1
10594	200	0,7	3,3	13,02	1-6-36 / 1

GN 1/9 - 108 X 176 mm



REF.	H(mm)	e(mm)	LITROS	€	UE / MOQ
10595	65	0,7	0,6	4,20	1-6-48 / 1
10596	100	0,7	0,8	6,32	1-6-48 / 1

GN 1/1 Perforada - Perforated - Perforé - Forate - Perforiert - 325 x 530 mm



REF.	H(mm)	e(mm)	€	UE / MOQ
10617	65	0,7	16,59	1-0-6 / 1
10618	100	0,7	22,18	1-0-6 / 1
10619	150	0,7	30,40	1-0-6 / 1
10620	200	0,7	34,27	1-0-6 / 1

GN 1/2 Perforada - Perforated - Perforé - Forate - Perforiert - 265 X 325 mm



REF.	H(mm)	e(mm)	€	UE / MOQ
10621	65	0,7	10,34	1-6-12 / 1
10622	100	0,7	13,72	1-6-12 / 1

Tapa GN inox
GN lid - Couvercle GN - Coperchio GN - GN-deckel



INOX
STAINLESS
STEEL
201

REF.	GN	e _(mm)	€	UE / MOQ
10630	1/1	0,7	11,18	1-0-6 / 1
10632	1/2	0,7	6,97	1-6-12 / 1
10633	1/3	0,7	5,26	1-6-18 / 1
10634	1/4	0,7	4,87	1-6-24 / 1
10635	1/6	0,7	3,02	1-6-36 / 1
10636	1/9	0,7	2,68	1-6-48 / 1

Tapa GN cierre hermético
GN hermetic lid - Couvercle étanche GN - Coperchio ermetico GN - GN-steck-deckel

Válvula para facilitar la apertura.

Valve for easy opening.



INOX
STAINLESS
STEEL
201

REF.	GN	e _(mm)	€	UE / MOQ
10637	1/1	0,7	37,31	1-0-6 / 1
10638	1/2	0,7	25,13	1-6-12 / 1
10639	1/3	0,7	21,97	1-6-18 / 1
10640	1/4	0,7	18,68	1-6-24 / 1
10641	1/6	0,7	15,26	1-6-36 / 1

INOX
STAINLESS
STEEL
201

Doble fondo perforado
Perforated bottom
Egouttoirs pour bacs
Falso fondo forato
Abtropfgitter



REF.	GN	e _(mm)	€	UE / MOQ
10612	1/1	0,7	18,29	1-0-10 / 1

INOX
STAINLESS
STEEL
201

Perfil divisorio GN
Adaptable bars
Barrettes de composition
Separatore
Adapter



REF.	GN	e _(mm)	€	UE / MOQ
10614	GN 1/1	0,7	6,18	1-0-120-0-0 / 1
10615	GN 1/2	0,7	3,81	1-0-120-0-0 / 1

Rueda de untar inox
Stainless steel spread wheel
Roue tartiner en acier inoxydable
Ruota per spalmare in acciaio inossidabile
Butterrad aus Edelstahl



REF.	W _(mm)	L _(mm)	H _(mm)	€
11602	160	175	125	36,27

Parrilla horno pastelera
Pastry oven grill 60x40
Gril au four pâtisserie 60x40
Griglia forno pasticceria 60x40
Backofengrill 60x40

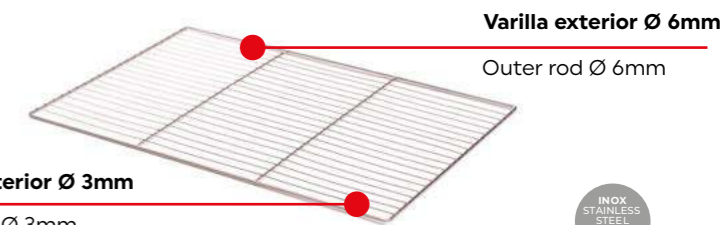

Varilla interior Ø 3mm
Inner rod Ø 3mm

Varilla exterior Ø 6mm
Outer rod Ø 6mm

INOX
STAINLESS
STEEL
430

REF.	W _(mm)	L _(mm)	€	UE / MOQ
11014	600	400	21,95	1-6-12 / 1

Parrilla horno GN 1/1
Oven grill gn 1/1
Gril au four gn 1/1
Griglia forno gn 1/1
Backofengrill gn 1/1

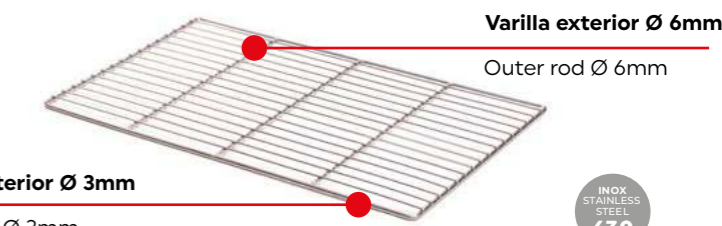

Varilla interior Ø 3mm
Inner rod Ø 3mm

Varilla exterior Ø 6mm
Outer rod Ø 6mm

INOX
STAINLESS
STEEL
430

REF.	W _(mm)	L _(mm)	€	UE / MOQ
11015	325	530	19,59	1-6-12 / 1



Carro Servicio
Serving Trolley
Chariot Service
Carrello Da Servizio
Servierwagen

INOX
STAINLESS
STEEL
201

REF.	LEVELS	Ø _(mm)	L _(mm)	H _(mm)	€	UE / MOQ
11774	2	860	540	940	162,65	0-0-1 / 1
11775	3	860	540	940	192,17	0-0-1 / 1

NEW

Funda carro trolley
Rack Trolley High
Chariot À Rack Élevé
Carrello Rack Alto
Hoher Tablettwagen Für

INOX
STAINLESS
STEEL
201

REF.	CARRO	€	UE / MOQ
12325	GN 1/1 408x575x1560	34,29	1-0-12 / 1
12326	60x40 510x650x1550	34,29	1-0-12 / 1



Ruedas pivotantes con freno en 2 de ellas.

Swivel castors with brakes on 2 of them.



Guía en "S", que permite una doble posición de las bandejas y mayor optimización del espacio.

S' guide, which allows double positioning of the trays and greater optimisation of space.



Varilla de seguridad bilateral para bloquear las bandejas.

Safety rod on the side to lock the trays.



GN
1/1

18 NIVELES
18 LEVELS



GN
1/1

9 NIVELES
9 LEVELS



GN
2/1

18 NIVELES
18 LEVELS



60x40
CM

18 NIVELES
18 LEVELS

● **Ligeros. Fabricados en acero inoxidable AISI 201.**
Lightweight. Made of AISI 201 stainless steel.

● **Resistentes. Soportan hasta 150 kg.**
Resistant. Supports up to 150 kg.

● **Fácil montaje.**
Easy assembly.

Carro Portabandejas Gn
Gn Container Trolley
Chariot Porte-Plateaux Gn
Carrello Portavassoi Gn
Gn-Tablett-/Regalwagen

REF.	SIZE	LAYERS	W(mm)	L(mm)	H(mm)	€	UE / MOQ
11769	GN 1/1	18	380	550	1735	273,47	0-0-1 / 1
11956	GN 1/1	9	380	550	1000	249,64	0-0-1 / 1
11770	GN 2/1	18	590	670	1735	457,74	0-0-1 / 1
11771	60x40	18	470	620	1735	316,63	0-0-1 / 1

INOX
STAINLESS
STEEL
201

Las barbacoas de sobremesa Caliu destacan por su diseño único y minimalista pero también por su versatilidad para trabajar múltiples técnicas y cocciones. El embellecedor reversible te permite elegir dos alturas diferentes con las que cocinar.

Caliu tabletop barbecues stand out for their unique and minimalist design and their versatility to multiple cooking methods and techniques. With the convertible outer house, you may choose between two different cooking heights.

Sin ensamblajes ni partes móviles, producida con pocas piezas para obtener un resultado robusto y duradero.

No assemblies or moving parts, produced with few parts for a robust and durable result.

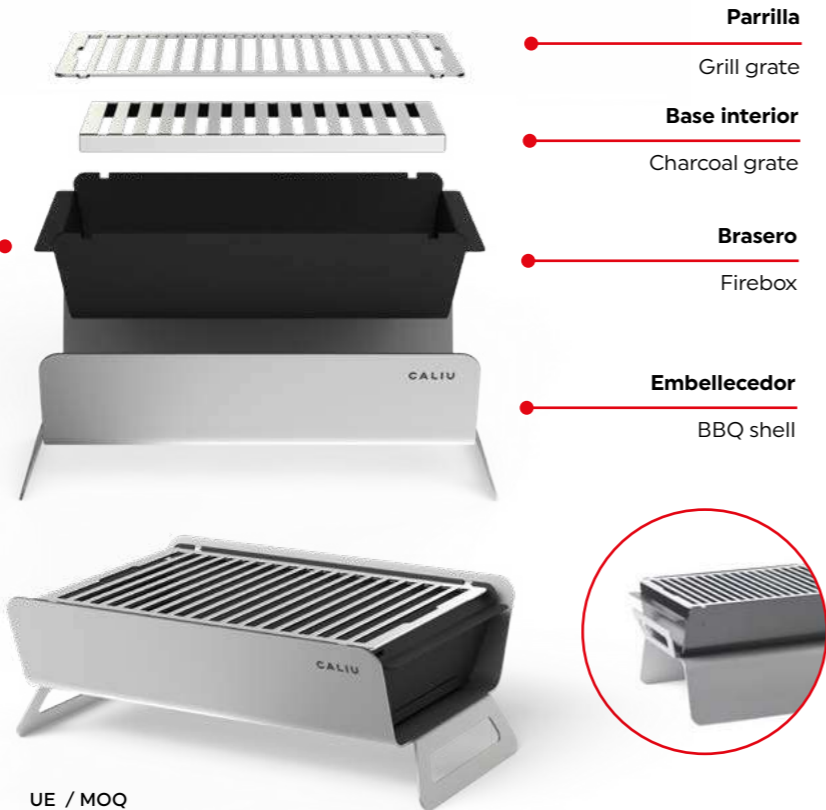

BBQ Caliu Horeca

REF.	W _(mm)	L _(mm)	H _(mm)	€	UE / MOQ
8500	300	452	160	229,81	1-0-1 / 1



BBQ Caliu Catering

REF.	W _(mm)	L _(mm)	H _(mm)	€	UE / MOQ
8684	300	860	160	406,35	1-0-1 / 1

INOX STAINLESS STEEL
430

Tapa BBQ

Bbq lid
Couvercle du bbq
Coperchio del bbq
Grilldeckel

REF.	W _(mm)	L _(mm)	H _(mm)	€	UE / MOQ
9969	260	370	140	77,49	1-0-4 / 1



Efecto horno, potencia los aromas.
Oven effect, enhances the aromas.



Parrilla

Grill grate

Base interior

Charcoal grate

Brasero

Firebox

Embellecedor

BBQ shell



Discover
Caliu's
World

INOX STAINLESS STEEL
304

PARRILLA

INOX STAINLESS STEEL
430

ESTRUCTURA

CALIU

INOX STAINLESS STEEL
430

Chimenea BBQ

Chimney BBQ
Cheminée BBQ
Grigliato camino BBQ
BBQ kamin



REF.	W _(mm)	L _(mm)	H _(mm)	€	UE / MOQ
8686	80	125	300	58,60	1-0-4 / 1

INOX STAINLESS STEEL
430

Pinza BBQ

Bbq tong
Pince bbq
Molla bbq
Zange bbq



REF.	W _(mm)	L _(mm)	€	UE / MOQ
8687	55	260	16,32	1-0-48 / 1



Plato brasa

Bbq plate
Assiette bbq
Piatto bbq
Grillplate

REF.	W _(mm)	L _(mm)	H _(mm)	€	UE / MOQ
S 8181	137	250	80	57,58	1-0-4 / 1
M 8685	137,5	354	82	59,08	1-0-4 / 1
L 11484	212,5	354	82	86,87	1-0-4 / 1
XL 11485	442	212,5	82	100,91	1-0-4 / 1

S



Aperitivo / Side

M



Degustación / Tasting

L



Principal / Main

XL



Compartir / Sharing

Recambio parrilla

Inox grill bbq spare part
Pièce de rechange inox grill bbq
Ricambio inox griglia bbq
Inox grill grillplate ersatzteil

REF.	W _(mm)	L _(mm)	€	UE / MOQ
S 11489	115	170	14,84	1-0-0 / 1
M 11490	121	272	17,71	1-0-0 / 1
L 11491	196	272	26,38	1-0-0 / 1
XL 11492	198	360	31,13	1-0-0 / 1

Base interior plato brasa

Interior base for grilled plate
Base intérieure pour plaque grillée
Base interna per piastra grigliata
Innensockel für grillplatte

REF.	W _(mm)	L _(mm)	H _(mm)	€	UE / MOQ
S 11578	95	90	10	9,25	1-0-0 / 1
M 11579	95	186	10	10,49	1-0-0 / 1
L 11580	170	186	10	13,99	1-0-0 / 1
XL 11581	170	274	10	17,04	1-0-0 / 1



PARRILLA ESTRUCTURA

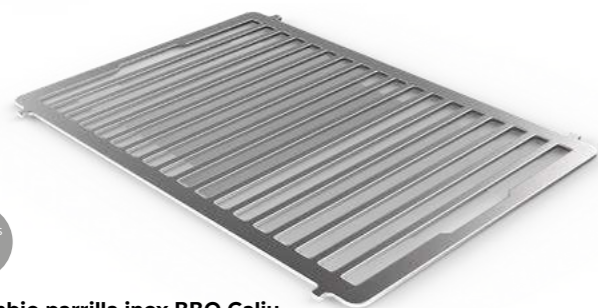

Recambio parrilla inox BBQ Caliu
Inox grill cali bbq
Pièce de rechange inox grill cali bbq
Ricambio inox griglia cali bbq
Inox cali grill grillplate ersatzteil

REF.	W(mm)	L(mm)	H(mm)	€	UE / MOQ
11495	268	363	3	74,07	1-0-10 / 1



Parrilla hierro fundido
Cast iron grill
Fonte grill
Ghisa griglia
Gusseisen grill

REF.	W(mm)	L(mm)	H(mm)	€	UE / MOQ
11487	255	363	10	53,40	1-0-0 / 1



Combina con recipientes 1/3, 1/6 y 1/9 GN.

Combines with 1/3, 1/6 and 1/9 GN.

Combina con Pinchos Touché.

Combines Touché Skewer see.

Combina con Llaunes COMAS.

Combines with Llaunes COMAS.

Combina con todas las parrillas CALIU.

Combines with all CALIU grates.



Plancha inox cromada
Chrome grill
Chromée grill
Cromata griglia
Chromeplatte

REF.	W(mm)	L(mm)	H(mm)	€	UE / MOQ
11486	267	323	5	182,00	1-0-0 / 1

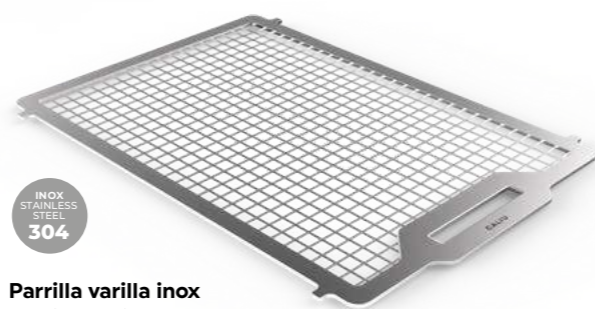

Parrilla varilla inox
Net inox grill
Inox filet grill
Inox griglia netta
Inox netz grill

REF.	W(mm)	L(mm)	H(mm)	€	UE / MOQ
11488	267	373	3	70,13	1-0-10 / 1



NO INCLUYE: BBQ Caliu catering
NOT INCLUDED: BBQ Caliu catering

Recambio barras móviles Robata Yaki
Spare Robata Yaki mobile bars
Pièce de rechange barre amovible
Ricambio barra estraibile
Abnehmbares ersatzteil für die stange

REF.	PCS	€	UE / MOQ
11066	2	76,32	1-0-10 / 1

Recambio bandeja superior Robata Yaki
Replacement top tray Robata Yaki
Pièce de rechange étagère
Ricambio mensola
Regal ersatzteil

REF.	PCS	€	UE / MOQ
11482	1	43,66	1-0-10 / 1

Robata grill YAKI

REF.	W(mm)	L(mm)	H(mm)	KG	€	UE / MOQ
10957	295	812	430	14	302,38	1-0-0 / 1

Con el Yaki, tendrás la libertad de cocinar de diversas maneras gracias a su diseño innovador y versátil.

Se compone de barras móviles que se colocan en las ranuras laterales de la barbacoa, lo que permite ajustar fácilmente la altura de la parrilla. Son ideales para Cubetes GN de 1/4 y 1/6, lo que te permite mantener salsas o guarniciones calientes y emplatar directamente.

With the Yaki, you have the freedom to cook in a variety of ways thanks to its innovative and versatile design.

It consists of movable bars that are placed in the side slots of the barbecue, allowing you to easily adjust the height of the grill. They are ideal for 1/4 and 1/6 GN tubs, allowing you to keep sauces or side dishes hot and plate them directly.

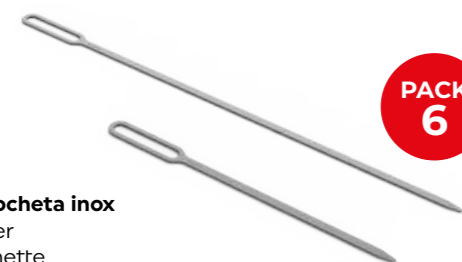

Pack 6 brocheta inox
Inox skewer
Inox brochette
Inox spiedo
Inox spieß

REF.	L(mm)	€	UE / MOQ
11493	350	34,79	1-0-50 / 1
11494	200	31,82	1-0-50 / 1



Recambio rejilla base interior bbq cali
Inner base cali horeca bbq
base intérieure cali horeca bbq
base interna cali horeca bbq
innere basis cali horeca bbq

REF.	W(mm)	L(mm)	H(mm)	€	UE / MOQ
5126	178	335	16	25,10	1-0-0 / 1

PACKAGING CUSTOM BOX



KITS BRASA
GRILL KITS

LLAUNES Y CARACOLERAS
LLAUNES AND SNAIL TRAYS



KIT CALIU 1. ESSENTIAL
BBQ Caliu + Pinza + Chimenea
BBQ Caliu + Tong + Chimney

REF.	€	UE / MOQ
8182	287,91	1-0-1 / 1

KIT CALIU 2. PREMIUM
BBQ Caliu + Tapa + Pinza + Chimenea
BBQ Caliu + Lid + Tong + Chimney

REF.	€	UE / MOQ
8183	359,16	1-0-1 / 1



KIT CALIU 3. CATERING PREMIUM
BBQ Caliu Catering + Tapa + Pinza + Chimenea
BBQ Caliu Catering + Lid + Tong + Chimney

REF.	€	UE / MOQ
11626	550,13	1-0-1 / 1



KIT CALIU 4. ROBATA YAKI
BBQ Caliu Catering + Robata Yaki + Pinza + Chimenea
BBQ Caliu Catering + Robata Yaki + Tong + Chimney

REF.	€	UE / MOQ
11627	768,75	1-0-1 / 1



PACKAGING
CUSTOM BOX



Llauna inox
St/st llauna
Llauna acier
Llauna acciaio
Llauna stahl

REF.	RACIONES	W(mm)	L(mm)	H(mm)	€	UE / MOQ
10689	TAPA	115	226	20	17,32	1-0-24 / 1
10690	1	115	331	20	20,47	1-0-24 / 1
10691	2	230	331	20	28,84	1-0-12 / 1



* Se vende por separado
Sold separately



Llauna CARBON STEEL
St/st llauna
Llauna acier
Llauna acciaio
Llauna stahl

REF.	RACIONES	W(mm)	L(mm)	H(mm)	€	UE / MOQ
10692	TAPA	115	226	20	12,97	1-0-24 / 1
10693	1	115	331	20	18,05	1-0-24 / 1
10694	2	230	331	20	22,79	1-0-12 / 1



* Se vende por separado
Sold separately



Base corcho
Cork base
Support en liège
Table di sughero
Korkbasis

REF.	W(mm)	L(mm)	H(mm)	€	UE / MOQ
10698	129	238	20	17,30	1-0-24-0-0 / 1
10699	129	343	20	23,77	1-0-24-0-0 / 1
10700	244	343	20	33,28	1-0-24-0-0 / 1



CLOSCA
Bandeja acero caracolera
Snail tray in stainless steel
Plateau en acier pour escargots
Vassoio in acciaio per lumache
Schneckenplatte aus Edelstahl

REF.	W(mm)	L(mm)	€	UE / MOQ
12194	180	180	8,00	1-6-54 / 6
12195	170	210	8,17	1-6-54 / 6
12196	220	220	9,09	1-6-54 / 6
12197	200	250	9,29	1-6-54 / 6





APTA PARA
LEÑA Y CARBÓN

BBQ HIERRO FUNDIDO CAST IRON BBQ

IGNIS

La grasa no se acumula en la plancha, lo que garantiza un punto de cocción perfecto.

Fat does not accumulate on the griddle, which guarantees a perfect cooking point.

Diseño de parrilla circular, fundida en una sola pieza, con mucha superficie operativa.

Circular grill design, cast in one piece, with a large operating surface.

Estructura de hierro fundido de alta calidad.

High quality cast iron structure.

Disco de
HIERRO
FUNDIDO
CAST IRON
Disc

Parrilla con salidas de aire ajustables que permiten el control preciso del calor para adaptarse a las diferentes necesidades del cocinado.

Grill with adjustable air vents that allow precise heat control to suit different cooking needs.

Recubierto con aceite vegetal, le proporciona antiadherencia a la superficie.

Coated with vegetable oil, it provides non-stick surface.

Excelente retención y distribución del calor.

Excellent heat retention and heat distribution.

Espacio para almacenar leña o carbón.

Space for storing firewood or charcoal.

4 ruedas pivotantes, 2 de ellas con freno.

4 swivel castors, 2 of them with brakes.



INCLUYE ARO ELEVADOR
ELEVATOR RING INCLUDED



INCLUYE PRENSA PARA CARNE
MEAT PRESS INCLUDED

Bbq Disco Hierro Colado IGNIS

Bbq Cast Iron Disc
Bbq Disque En Fonte
Bbq Disco In Ghisa
Bbq Drehscheibe Gusseisen

REF.	PESO	€	UE / MOQ
11978	110	1.874,90	0-0-1/1



Conoce
Ignis.

Plato de hierro fundido adecuado tanto para mantener como para terminar la cocción en mesa. El plato viene acompañado de una base de madera para poder servir en mesa.

Cast iron plate suitable both for holding and for finishing cooking at the table. The plate comes with a wooden base for serving at the table.



PLATO HIERRO FUNDIDO
CAST IRON PLATE

Aguanta hasta 350C°. Después de usar, dejar enfriar y lavar a mano con agua y jabón. Secar con un paño suave y poner una capa de aceite para mejor conservación.

It can withstand up to 350C°. After use, leave to cool and wash by hand with soap and water. Dry with a soft cloth and coat with oil for better preservation.

BASE DE ACACIA
ACACIA WOOD BASE

Base de madera acacia que sirve como soporte del plato de hierro fundido. Lavar con un paño suave.

Acacia wood base that serves as a support for the cast iron plate. Wash with a soft cloth.

INOX
STAINLESS
STEEL
304

Plato hierro fundido + Base madera acacia

Cast iron plate + Acacia wood base
Plaque en fonte + socle en bois d'acacia
Piastra in ghisa + base in legno d'acacia
Platte aus Gusseisen + Unterteller eichenholz

REF.	Ø(mm)	L BASE CON ASAS	€	UE / MOQ
11973	300	360	38,37	1-0-4 / 1
12007	350	410	49,98	1-0-3 / 1



NEW

Base madera acacia
Acacia wood base
Socle en bois d'acacia
Base in legno d'acacia
Unterteller eichenholz

REF.	Ø(mm)	€	UE / MOQ
10861	370	25,65	1-0-8 / 1
10862	320	21,33	1-0-6 / 1



Piedra de 20mm de espesor que mantiene perfectamente el calor para presentación en mesa y acabado de punto de cocción.

20mm thickness stone maintains perfectly the heat for table presentation and finishing cooking point.

Sus bordes inclinados facilitan la recogida de grasas y líquidos.

Sloping edges ease the fat and liquid collection.

Punto de sujeción y elevación para aislamiento térmico.

Subjection point and elevation for thermal insulation.

Canales para recogida de líquidos y potenciar la circulación de aire.

Liquid collecting channels enhances air circulation.



Piedra Basalto
Basalt Stone
Pierre De Basalte
Pietra In Basalto
Basaltstein

REF.	W(mm)	L(mm)	H(mm)	€	UE / MOQ
11825	240	240	20	17,56	1-0-39 / 1
11826	325	325	20	34,21	1-0-25 / 1
11948	328	228	20	20,53	1-0-50 / 1



* Compatible sólo con base de corcho. REF.: 10700



Plato Ceramica
Ceramic Dish
Assiette Porcelaine
Piatto In Porcellana
Porzellanteller

REF.	W(mm)	L(mm)	H(mm)	€	UE / MOQ
11820	275	275	32	55,66	0-1-12 / 1
11822	350	350	30	105,41	0-1-6 / 1
11821	520	280	32	94,16	0-1-8 / 1



SIMPLE
240 x 240 mm
H: 20 mm

REDONDO
328 x 228 mm
H: 10 mm

DOBLE
Ø 320 mm
H: 20 mm



Fabricados en cuero de alta calidad y forrados en el interior.

Manufactured in high-quality leather and lined.



Sus puños largos proporcionan una protección extra para los antebrazos.

The long cuffs provide extra protection for your forearms.

Guantes piel para horno

Leather oven gloves
Gants de four en cuir
Guanti da forno in pelle
Lederhandschuhe

REF.	L(mm)	€	UE / MOQ
10715	460	23,05	1-0-50 / 1

* Estos guantes cumplen con la normativa Europea 2016/425 y EN 407:2004 nivel 3 relativo a los equipos de protección individual (EPI).

These gloves are compliant with EU Regulation 2016/425 concerning personal protective equipment (PPE) and meet EN 407:2004 Level 3, for work gloves.

INOX STAINLESS STEEL 304

Escurre fritos y carnes

Fry colander
Passoire à frites
Cesta per friggere
Frittensieb



REF.	W(mm)	L(mm)	€	UE / MOQ
8381	290	400	157,17	1-0-6 / 1
8382	390	500	193,77	1-0-4 / 1
8383	390	600	220,60	1-0-3 / 1

Esprai aceite

Oil spray
Pulvérisateur d'huile
Spray d'olio
Ölspray



REF.	ml	H(mm)	€	UE / MOQ
9997	100	180	3,79	1-0-24 / 1

Base de esparto

Placemat
Sets de table
Tovaglietta
Platzmatten



REF.	Ø(mm)	€	UE / MOQ
10716	380	9,73	1-4-48 / 1

Cepillo limpia barbacoa

Placemat
Sets de table
Tovaglietta
Platzmatten



REF.	L(mm)	€	UE / MOQ
9995	415	11,51	1-0-12 / 1

Punta plana para girar o coger alimentos con precisión.

Flat tip for precise turning or picking up food.



Pinza BBQ
BBQ tong
Pince BBQ
Pinze BBQ
BBQ zange

REF.	W(mm)	L(mm)	H(mm)	€	UE / MOQ
10682	100	405	27	26,31	1-0-24 / 1

INOX STAINLESS STEEL 430

Pack 6 pinchos inox

Pack 6 ss skewers inox
Pack 6 piques acier
Pack 6 spiedo acciaio
Pack 6 spießchen stahl

REF.	L(mm)	€	UE / MOQ
9993	250	3,48	1-24-96 / 1
9994	300	3,85	1-24-96 / 1

Besuguera

Fish grill
Grill à poisson
Griglie per pesce
Fischgrillkorb aus edelstahl

REF.	SIZE	W(mm)	H(mm)	H _{mm}	€	UE / MOQ
10679	S	165	80	370	14,81	1-0-6 / 1
10680	M	200	100	370	15,82	1-0-6 / 1
10681	L	290	120	420	18,58	1-0-4 / 1

Gancho central para facilitar el manejo de las parrillas.

Central hook for easy handling of the grills.



Mango recubierto de PVC para mayor comodidad.

PVC coated handle for comfort.

Pinza BBQ plana
BBQ tong flat
Pince BBQ plain
Pinze BBQ piano
BBQ zange boden

REF.	W(mm)	L(mm)	H(mm)	€	UE / MOQ
10683	100	405	55	36,83	1-0-24 / 1

INOX STAINLESS STEEL 304

Pack 6 brocheta inox

Inox skewer
Inox brochette
Inox spiedo
Inox spieß

REF.	L(mm)	€	UE / MOQ
11493	350	34,79	1-0-0 / 1
11494	200	31,82	1-0-0 / 1

PACK 6

INOX STAINLESS STEEL 430



Garantiza la sostenibilidad de este producto.

It guarantees the sustainability of this product.



Tiempo de combustión: 15 minutos

Burning time: 15 minutes



Pastillas naturales y ecológicas, procedentes de residuos naturales.

Natural and environmentally friendly tablets from natural waste.



No producen olores y no son tóxicas.

They are odourless and non-toxic.



Lanas de encendido
Firelighters
Laine De Bois Pour Allumage
Lana Di Legno Accendi
Bbq Anzündler

X32

REF.	PESO	€	UE / MOQ
11974	400gr. (aprox.)	7,86	1-0-0 / 1

CASCARA DE COCO CARBONIZADA Y COMPACTADA

CARBONISED AND COMPACTED COCONUT SHELLS.



Briqueta de COCO
COCONUT Briquette
Briquette de COCO
Bricchetto di COCCO
Kokosnussbrikett

REF.	PESO
10803	5Kg
10804	10Kg



€	UE / MOQ
26,96	1-0-0 / 1
53,92	1-0-1 / 1



SERRÍN DE COCO COMPACTADO

COMPACTED COCONUT SHELLS



Carbón de coco sawdust
Coconut charcoal sawdust
Charbon de coco sawdust
Carbone di cocco sawdust
Kokosnusskohle sawdust

REF.	PESO
11641	10Kg



€	UE / MOQ
40,56	1-0-1 / 1

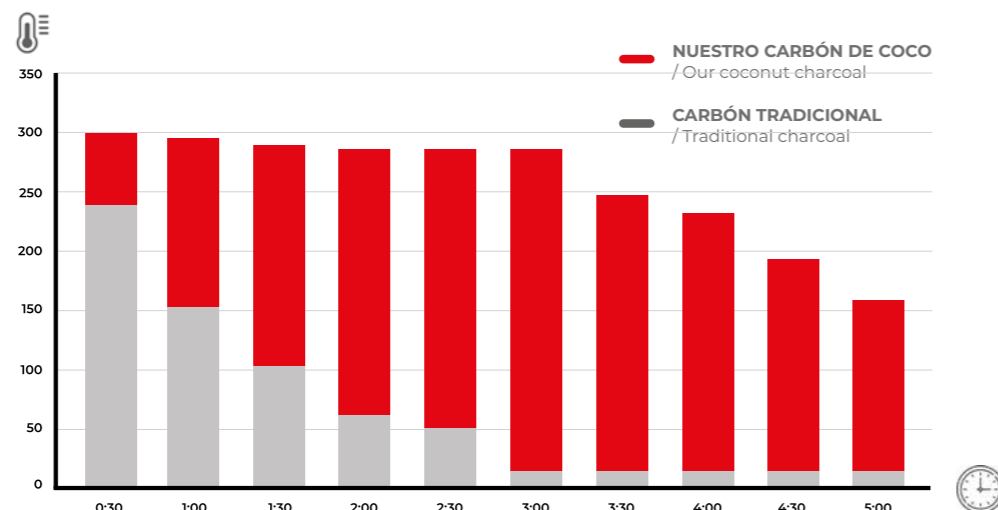

+2,5 HORAS DE COMBUSTIÓN Y MÁXIMA EFICIENCIA CALORÍFICA.

+2,5 HOURS OF COMBUSTION AND MAXIMUM HEAT EFFICIENCY.

VENTAJAS CARBÓN DE COCO SAWDUST / ADVANTAGES OF SAWDUST COCONUT CHARCOAL



SIN LLAMA
Más control sobre la cocción de alimentos.

FLAMELESS
More control over the cooking of food.



SIN CHISPAS
Apto para uso en interiores.

SPARKLESS
Suitable for indoor use.



SIN HUMO
No altera el sabor de los alimentos.

NO SMOKE
It does not alter the taste of food.

- Limpio / Clean
- Eficiente / Efficient
- Económico / Economic
- Útil / Useful
- Ecológico / Ecologic
- Seguro / Safe
- Cómodo / Convenient
- Sin gases sulfúricos tóxicos / No toxic sulphuric fumes



ALTO PODER CALÓRICO
HIGH CALORIC POWER



ORIGEN CARIBEÑO
CARIBBEAN ORIGIN



DURACIÓN 4H
DURATION 4H

**MEZCLA
ARTESANA
DE CARBÓN
VEGETAL**

**ARTISAN
CHARCOAL
BLEND**



MARABÚ

Alta densidad y poder calórico. Aromas nobles y baja producción de humo y ceniza.

High-density and high performance, noble aromas and low smoke and ash production.



CASUARINA

De muy alto poder calórico, proporcionando potencia y un mayor rendimiento.

Higher efficiency, providing power and increased performance.



JÚCARO

Aporta estabilidad y control a la mezcla aportando una mayor eficiencia y durabilidad.

It provides stability and control to the blend giving more efficiency and durability.



El cumplimiento de la normativa REACH garantiza el control de calidad del producto, descartando la deforestación de bosques y la mano de obra infantil.

REACH compliance guarantees product quality control, ruling out deforestation of forests and child labour.

Saco de carbón vegetal marabú, casuarina y júcaro

Vegetable charcoal marabú, casuarina and júcaro
Charbon végétal marabú, casuarina et júcaro
Carbone végétale marabú, casuarina e júcaro
Pflanzliche kohle marabú, casuarina und júcaro

REF.	PESO	€	UE / MOQ
11058	10	35,71	1-0-1 / 1

Surtido carbones: Sawdust / Vegetal / Coco

Vegetable charcoal marabú, casuarina and júcaro
Charbon végétal marabú, casuarina et júcaro
Carbone végétale marabú, casuarina e júcaro
Pflanzliche kohle marabú, casuarina und júcaro



REF.	PESO	€	UE / MOQ
12047	270Kg	120,15	1 PALET

Leña de vid procedente de viñedos de 100 años de antigüedad. Cortados en trozos pequeños y manejables que mantienen un excelente aroma.

Vine wood from 100 year old vineyards. Cut into small, manageable pieces that maintain an excellent aroma.



Madera de Vid

Vine Vid
Bois de vigne
Legno di vite
Rebenholz

REF.	PESO	€	UE / MOQ
12014	7Kg aprox	25,51	1-0-0 / 1

**FRESCO
FRESH**

Envasado según pedido para garantizar la máxima frescura y preservar todos los beneficios del producto.

We pack to order to guarantee maximum freshness and preserve all the benefits of the product.



REF: 11975

SHUNKS DE RAÍZ DE VID

- Granulometría gruesa hasta 100mm.
Coarse granulometry 100mm.

- Apto para smokers, kamados y técnicas de ahumados de larga duración.
Suitable for smokers kamados and long-lasting smoked.

- No necesita hidratación.
No hydration needed.



REF: 11976

CHIPS CASCARA ALMENDRA

- Granulometría media hasta 50mm.
Coarse granulometry 50mm.

- Apto para hornos de brasa, bbq abiertas para aromatización rápida.
Suitable for ember oven, open bbq for quick aromatisation.

- No necesita hidratación.
No hydration needed.



REF: 11977

SERRÍN DE RAÍZ OLIVO / ALMENDRO

- Granulometría fina.
Fine granulometry.

- Apto para aromatizadores, para aportar aromas a las elaboraciones gastronómicas y del mundo del cocktail.
Suitable for aromatisers to provide flavoring to gastronomical elaborations and cocktail world.

Bbq Aroma, Bbq Flavour, Bbq arôme, Aroma bbq, Bbq geruch.

REF.	PESO Kg	€	UE / MOQ
11975	2	14,29	1-0-0 / 1
11976	2	14,29	1-0-0 / 1
11977	0,150	6,80	1-0-0 / 1



**ENVASADO
SEGÚN
PEDIDO**
**PACKED
TO ORDER**

CATERING Y BUFFET



LES ESSENCES

- 410 SOPORTES
- 412 BANDEJAS GN 1/1
- 413 LED
- 414 BANDEJAS
- 416 VAJILLA PORCELANA
- 418 SET CUBERTERÍA
- 419 CUCHARAS DEGUSTACIÓN

BUFFET

- 420 CAJAS GN MADERA
- 422 JARRAS Y LECHERAS
- 423 KIT SERVIR ELEGANT
- 428 PINZAS



Soporte conos

Cones support
Support cornets
Supporto per coni finger food
Auflage für kegel



REF.	COLOR	W(mm)	L(mm)	H(mm)	€	UE / MOQ
7586	●	120	240	40	15,17	1-4-16 / 1
7595	●	120	240	40	9,03	1-4-16 / 1



Soporte piruletas

Lollipops support
Support sucettes
Supporto spiedini finger food
Display für lollies



REF.	COLOR	W(mm)	L(mm)	H(mm)	€	UE / MOQ
7585	●	120	240	40	15,57	1-4-16 / 1
7594	●	120	240	40	9,03	1-4-16 / 1



Bandeja madera roble

Oak wood tray
Plateau en chêne
Vassoio legno quercia
Eichenholz tablett



Se vende por separado.
Sold separately.

REF.	W(mm)	L(mm)	H(mm)	€	UE / MOQ
7587	120	240	10	13,24	1-4-16 / 1

PACKAGING
CUSTOM BOX



Soporte para tacos

Tacos support
Plat support à tacos
Supporto per tacos
Auflage für tacos



REF.	COLOR	W(mm)	L(mm)	H(mm)	€	UE / MOQ
7583	●	120	240	40	19,24	1-4-16 / 4
7592	●	120	240	40	11,48	1-4-16 / 4



Soporte para brochetas

Skewers support
Support brochette
Supporto per spiedini lunghi
Spießhaltr



REF.	COLOR	W(mm)	L(mm)	H(mm)	€	UE / MOQ
7584	●	60	240	30	12,46	1-4-16 / 4
7593	●	60	240	30	7,51	1-4-16 / 4



4 PASOS CON UNA SOLA BANDEJA / 4 STEPS WITH ONLY ONE TRAY

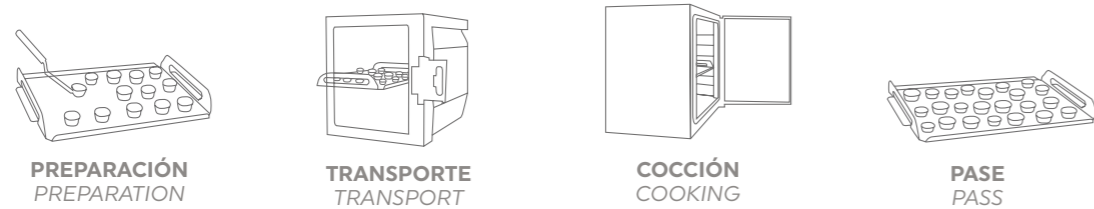

Bandeja GN 1/1
Tray GN 1/1
Plateau silver GN 1/1
Vassoio silver GN 1/1
Silver tablett GN 1/1

REF.	COLOR	W(mm)	L(mm)	H(mm)	€	UE / MOQ
11143	●	325	530	74	39,01	1-4-8 / 1
11144	●	325	530	74	39,01	1-4-8 / 1

Cubrebandeja silicona GN 1/1
Silicon tray cover GN 1/1
Couvercle plateau silicone GN 1/1
Coperchio vassoio in silicone GN 1/1
Tablett mit silikonbeschichtung GN 1/1

REF.	W(mm)	L(mm)	€	UE / MOQ
10785	325	530	13,74	1-4-64 / 4



Efecto láminas acetato.

Luz regulable en 3 intensidades.
Light adjustable in 3 intensities.

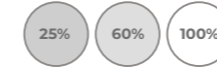

No sumergible.
Lavable con paño húmedo.

Non-submersible.
Washable with a damp cloth.



Botón táctil de apagado y encendido.
Touch button for power on/off.



Batería recargable por USB.
USB rechargeable battery.



Patas de silicona para una mayor fijación en la superficie.
Silicone feet for a better fixation on the surface.

Adaptable a bandeja GN 1/1
Compatible with GN 1/1

Base Led GN 1/1
Led board tray GN 1/1
Support led plateau GN 1/1
Supporto led per teglie GN 1/1
GN 1/1 tablett led



Lámina metacrilato protector.
Methacrylate protective sheet
Feuille protectrice méthacrylate
Foglio protettivo in metacrilato
Methacrylat schutzblatt



REF.	W(mm)	L(mm)	€	UE / MOQ
10784	325	530	159,18	1-0-1 / 1

REF.	W(mm)	L(mm)	€	UE / MOQ
10808	317	480	19,01	1-0-1 / 1



Lámina acetato personalizable
Customisable acetate film
Film acétate personnalisable
Pellicola di acetato personalizzabile
Individuell gestaltbare Acetatfolie

REF.	W(mm)	L(mm)	MODELO	€	UE / MOQ
10786	297	420	A - AGUA	9,04	1-0-6 / 1
10799	297	420	B - FUEGO	9,04	1-0-6 / 1
10800	297	420	C - TIERRA	9,04	1-0-6 / 1
10801	297	420	D - AIRE	9,04	1-0-6 / 1
*	297	420	E - PERSONALIZADO	9,04	1-0-6 / 1

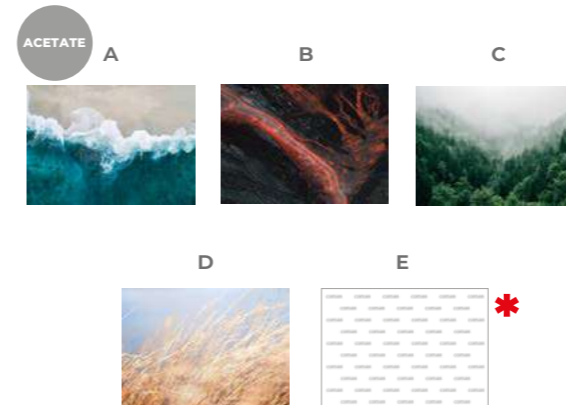
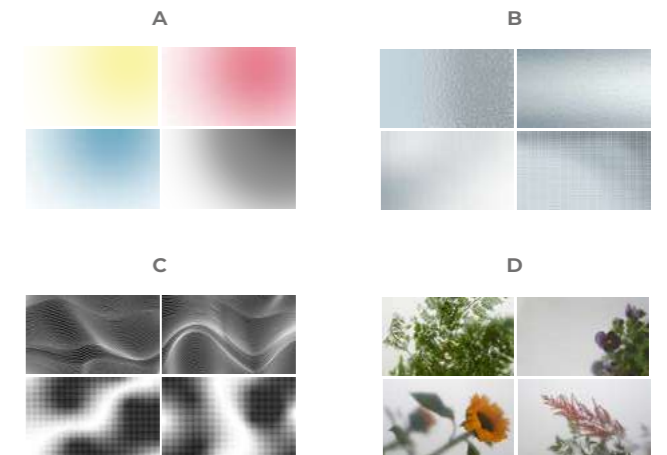

Pack 4 lámina acetato
Customisable acetate film
Film acétate personnalisable
Pellicola di acetato personalizzabile
Individuell gestaltbare Acetatfolie

REF.	W(mm)	L(mm)	MODELO	€	UE / MOQ
10975	297	420	A - CHROMATIQUE	36,18	1-0-6 / 1
10976	297	420	B - GLASSIER	36,18	1-0-6 / 1
10977	297	420	C - KONTRAST	36,18	1-0-6 / 1
10978	297	420	D - PLANTS	36,18	1-0-6 / 1



Bandeja rectangular pequeña
Catering tray
Plateau de présentation
Vassoio catering
Catering tablett

REF.	COLOR / MATERIAL	W(mm)	L(mm)	H(mm)	€	UE / MOQ
7579	●	150	270	69	23,36	1-4-16 / 4
7588	●	150	270	69	14,16	1-4-16 / 4
7438	SILICONA / SILICONE	145	265		4,05	1-4-64 / 4
7845	CORCHO / CORK	145	265		4,68	1-4-64 / 1

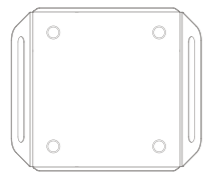

Bandeja cuadrada
Catering tray
Plateau de présentation
Vassoio catering
Catering tablett

REF.	COLOR / MATERIAL	W(mm)	L(mm)	H(mm)	€	UE / MOQ
7581	●	285	270	69	32,71	1-4-16 / 4
7590	●	285	270	69	19,08	1-4-16 / 4
7440	SILICONA / SILICONE	280	265		7,58	1-4-64 / 4
7847	CORCHO / CORK	280	265		8,87	1-4-64 / 1



Bandeja rectangular estrecha
Catering tray
Plateau de présentation
Vassoio catering
Catering tablett

REF.	COLOR / MATERIAL	W(mm)	L(mm)	H(mm)	€	UE / MOQ
7580	●	150	525	69	29,59	1-4-16 / 4
7589	●	150	525	69	17,59	1-4-16 / 4
7439	SILICONA / SILICONE	145	520		7,58	1-4-64 / 4
7846	CORCHO / CORK	145	520		9,10	1-4-64 / 1

PACKAGING
CUSTOM BOX



COLOR:
SOFT ARGENTO



COLOR:
PURE CARBON



COLOR:
SOFT ARGENTO



COLOR:
PURE CARBON



COLOR:
SOFT ARGENTO



COLOR:
PURE CARBON



Bandeja rectangular grande
Catering tray
Plateau de présentation
Vassoio catering
Catering tablett

REF.	COLOR / MATERIAL	W(mm)	L(mm)	H(mm)	€	UE / MOQ
7582	●	285	525	69	49,52	1-4-16 / 1
7591	●	285	525	69	29,37	1-4-16 / 1
7441	SILICONA / SILICONE	280	520		12,02	1-4-64 / 4
7848	CORCHO / CORK	280	520		17,62	1-4-64 / 1



COLOR:
SOFT ARGENTO



COLOR:
PURE CARBON



Bandeja Room service
Room service tray
Plateau à servir
Vassoio servizio in camera
Zimmerservice tablett

REF.	COLOR / MATERIAL	W(mm)	L(mm)	H(mm)	€	UE / MOQ
7930	●	385	520	120	39,19	1-4-16 / 4
7931	CORCHO CORK	380	515		16,97	1-4-64 / 1



COLOR:
PURE CARBON

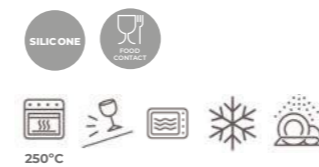

Cubrebandeja silicona
Silicone tray cover
Couvercle plateau silicone
Coperchio vassoio in silicone
Tablett mit silikonbeschichtung

REF.	W(mm)	L(mm)	€	UE / MOQ
7438	145	265	4,05	1-4-64 / 4
7439	145	520	7,58	1-4-64 / 4
7440	280	265	7,58	1-4-64 / 4
7441	280	520	12,02	1-4-64 / 4



Cubrebandeja corcho rectangular
Cork tray cover
Couvre plateau en liège
Coperchio per vassoio in sughero
Kork-auflage für tablett

REF.	W(mm)	L(mm)	€	UE / MOQ
7845	145	265	4,68	1-4-64 / 1
7846	145	520	9,10	1-4-64 / 1
7847	280	265	8,87	1-4-64 / 1
7848	280	520	17,62	1-4-64 / 1
7931	380	515	16,97	1-4-64 / 1





Porcelana de alta calidad fabricada en 2 tiempos de cocción a más de 1200°C, que le proporciona impermeabilidad, resistencia y suavidad al tacto.

High Quality porcelain made in 2 times firing beyond 1200°C provides impermeability, resistance and soft touch.



Versatilidad, composición, orden, apilabilidad, practicidad... El sistema modular de la vajilla LES ESSENCES, facilita el trabajo de un servicio de catering.

Versatility, composition, order, stackability, practicality... The modular system LES ESSENCES, facilitates the work in a catering service.

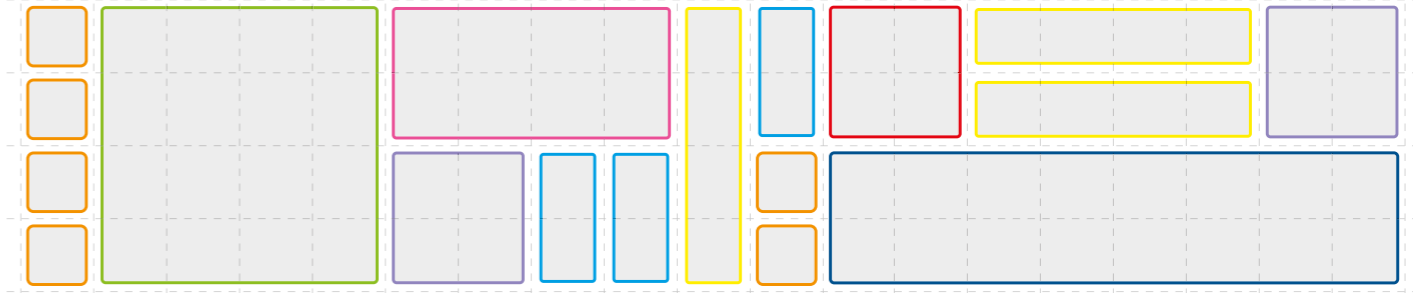

Plato Postre Half
Half Dessert Plate Assiette Dessert Half
Piatto Dolce Half
Dessertteller Half



REF.	W(mm)	L(mm)	H(mm)	€	UE / MOQ
11972	60	120	18	3,50	0-6-144 / 6



Vaso
Cup
Verre
Bicchiere
Becher



REF.	W(mm)	L(mm)	H(mm)	ml	€	UE / MOQ
7679	60	60	60	70	2,47	1-4-72 / 4

Bol
Bowl
Bol
Ciotola
Quadratische schale



REF.	W(mm)	L(mm)	H(mm)	ml	€	UE / MOQ
7670	120	120	60	400	7,46	1-4-48 / 4

Plato postre
Dessert plate
Assiette à dessert
Piatto dolce
Dessert platte



REF.	W(mm)	L(mm)	H(mm)	€	UE / MOQ
7681	120	120	18	4,36	1-4-64 / 4

Barquillo
Wafer
Barquette
Vassoietto fondo
Waffel



REF.	W(mm)	L(mm)	H(mm)	€	UE / MOQ
7680	60	240	18	5,31	1-4-64 / 4

Plato llano
Dinner plate
Assiette plate
Piatto piano
Teller



REF.	W(mm)	L(mm)	H(mm)	€	UE / MOQ
7672	240	240	13	15,69	1-4-24 / 4

Bandeja simple
Simple tray
Plateau simple
Vassoio semplice
Tablett



REF.	W(mm)	L(mm)	H(mm)	€	UE / MOQ
7671	120	240	15	10,56	1-4-48-3 / 4

Bandeja doble
Double tray
Plateau double
Vassoio doppio
Doppeltes tablett



REF.	W(mm)	L(mm)	H(mm)	€	UE / MOQ
7673	120	480	13	17,08	1-4-24 / 4



PACKAGING CUSTOM BOX



INOX STAINLESS STEEL 420

Cuchillo Vintage
Vintage Knife
Couteau Vintage
Coltello Vintage
Vintage-Messer

REF.	L(mm)	€	UE / MOQ
11662	115	4,27	0-12-120 / 12

INOX STAINLESS STEEL 304

Tenedor Vintage
Vintage Fork
Fourchette Vintage
Forchetta Vintage
Vintage-Gabel

REF.	L(mm)	€	UE / MOQ
11663	117	2,62	0-12-120 / 12

INOX STAINLESS STEEL 304

Tenedor Mini Vintage
Vintage Mini Fork
Fourchette Mini Vintage
Forchetta Mini Vintage
Mini-Vintage-Gabel

REF.	L(mm)	€	UE / MOQ
11664	72	2,54	0-12-120 / 12

INOX STAINLESS STEEL 304

Pincho Vintage
Vintage Skewer
Brochette Vintage
Set Da Aperitivo Vintage
Vintage-Spiess

REF.	L(mm)	€	UE / MOQ
11665	104	2,36	0-12-120 / 12

ACACIA WOOD

Soporte Cubiertos Individual
Cutlery Rest Individual
Support-Couverts Individuel
Supporto Posate Individuale
Besteckhalter Einzel

REF.	W(mm)	L(mm)	H(mm)	€	UE / MOQ
11667	60	54	15	6,16	0-12-240 / 12

ACACIA WOOD

Soporte Cubiertos Triple
Cutlery Rest Triple
Support-Couverts Triple
Supporto Posate Triplo
Besteckhalter Mit Drei Fächern

REF.	W(mm)	L(mm)	H(mm)	€	UE / MOQ
11666	60	145	15	7,07	0-4-80 / 4

Cuchara arrastre
Drag spoon
Cuillère à glisser
Cucchiaio drag
Drag-probierlöffel

REF.	COLOR	L(mm)	€	UE / MOQ
7568	Perforada vintage	75	3,05	0-12-120 / 12
7569	Vintage	75	2,88	0-12-120 / 12
7570	Vintage pvd intense gold	75	6,09	0-12-120 / 12
7571	Vintage pvd pure carbon	75	6,09	0-12-120 / 12



Cuchara acompañamiento
Accompaniment spoon
Cuillère d'accompagnement
Cucchiaio per accompagnamento
Begleitung probierlöffel

REF.	COLOR	L(mm)	€	UE / MOQ
7564	Perforada vintage	120	3,53	0-12-120 / 12
7565	Vintage	120	3,37	0-12-120 / 12
7566	Vintage pvd intense gold	120	6,57	0-12-120 / 12
7567	Vintage pvd pure carbon	120	6,57	0-12-120 / 12



Cuchara aperitivos de montaje
Appetizer assembly spoon
Assemblage du cuillères apéritif
Assemblaggio cucchiaio antipasto
Probierlöffel-montage-vorspeise

REF.	COLOR	L(mm)	€	UE / MOQ
7572	Perforada vintage	71	3,21	0-12-120 / 12
7573	Vintage	71	3,05	0-12-120 / 12
7574	Vintage pvd intense gold	71	6,25	0-12-120 / 12
7575	Vintage pvd pure carbon	71	6,25	0-12-120 / 12



Cuchara aperitivos de montaje plana
Flat appetizer assembly spoon
Cuillère plate pour assamblage
Cucchiaio piatto per antipasti da assemblato
Flacher snacklöffel

REF.	COLOR	L(mm)	€	UE / MOQ
7576	Vintage	85	2,72	0-12-120 / 12
7577	Vintage pvd intense gold	85	5,93	0-12-120 / 12
7578	Vintage pvd pure carbon	85	5,93	0-12-120 / 12





GN 1/3 7835 176 x 325mm	GN 1/1 7833 325 x 530mm	GN 2/4 7836 162 x 530mm	GN 1/2 7834 265 x 325mm
GN 2/3 325 x 353mm			GN 1/4 7541 162 x 265mm
			GN 1/6 162 x 176mm
			GN 1/9 108 x 176mm



Cajas diseñadas para contener cualquier cubeta o accesorio GN.

Designed to contain whatever pail or GN accessory.

*medidas interiores / internal dimensions

ALTURAS DE CUBETAS GN COMPATIBLES
COMPATIBLE GN TRAY HEIGHTS

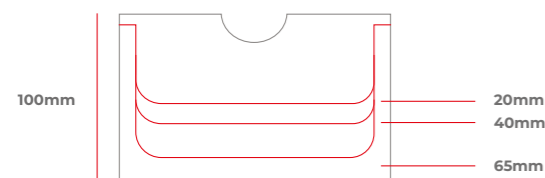

Los accesorios GN quedan encajados en el interior de las cajas, apoyados sobre las esquinas.

GN accessories fit inside the boxes, rested over the corners.



7833



7836



7834



7835



7541

Caja haya
Beech wood box
Cagette en bois
Cassetta legno
Holzbox für behälter



REF.	GN	W(mm)	L(mm)	H(mm)	€	UE / MOQ
7833	1/1	325	530	100	46,99	1-0-4 / 1
7834	1/2	265	325	100	32,29	1-0-4 / 1
7835	1/3	176	325	100	26,64	1-0-6 / 1
7541	1/4	265	162	100	24,19	1-0-6 / 1
7836	2/4	162	530	100	42,25	1-0-4 / 1

PACKAGING
STICKER



Soporte alzador cajas madera
Structure height adjuster
Support réhausseur
Telaio per alzata
Strukturierter höhenregulator

REF.	W(mm)	L(mm)	L(mm)	€	UE / MOQ
7838	325	530	100	12,80	1-0-4 / 4



Soporte alzador cajas madera
Structure height adjuster
Support réhausseur
Telaio per alzata
Strukturierter höhenregulator

REF.	W(mm)	L(mm)	H(mm)	€	UE / MOQ
7837	325	530	180	17,60	1-0-4 / 4



Alzador cajas madera
Height adjuster wood boxes
Réhausseur boîte en bois
Supporto per cassetta legno
Höhenregulator für Holzboxen

REF.	W(mm)	L(mm)	H(mm)	€	UE / MOQ
7839	40	40	60	4,47	1-4-64 / 4



Pinza servir haya punta redonda
Round head beechwood server tong
Pince à servir en bois à bout rond
Molla servire legno punta rotonda
Holzservierzange, runder kopf

REF.	L(mm)	€	UE / MOQ
7549	305	4,40	1-12-72 / 1



Punta ondulada
Wavy tip

Pinza servir haya punta fina
Slim head beechwood server tong
Pince à servir en bois à bout fin
Molla servire legno a punta
Holzservierzange, dünner kopf

REF.	L(mm)	€	UE / MOQ
7550	305	4,40	1-12-72 / 1

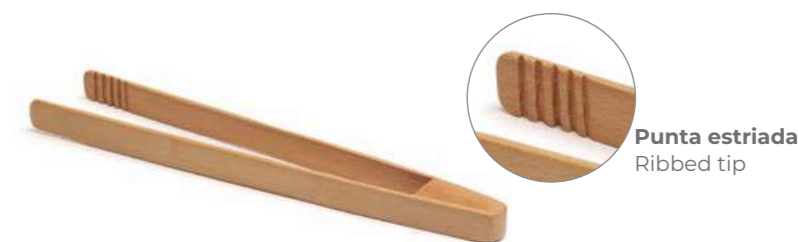

Punta estriada
Ribbed tip

PACKAGING
BLISTER



BUFFET

ACCESORIOS / JARRAS Y LECHERAS
ACCESORIES / JARS AND MILK JUGS

ELEGANT COLLECTION



PINZAS / TONGS



Cesta cubiertos madera
Wood cutlery dispenser
Panier à couverts en bois
Portaposate legno
Besteck-ablage aus Holz



REF.	W(mm)	L(mm)	H(mm)	€	UE / MOQ
8430	325	530	100	55,65	1-0-4 / 1



Caja madera portacubiertos
Wood cutlery box
Plateau à couverts en bois
Portaposate legno
Besteckbehal aus Holz



REF.	W(mm)	L(mm)	H(mm)	€	UE / MOQ
8473	150	280	50	36,06	1-0-6 / 1



BOROSILICATE

+ RESISTENCIA
RESISTANCE

Jarra cristal tapón corcho
Glass jar with cork lid
Pichet en verre avec couvercle liège
Caraffa in vetro con coperchio in sughero
Glaskrug mit korkdeckel

REF.	Ø(mm)	H(mm)	ml	€	UE / MOQ
10806	105	178	1.200	26,09	1-0-24 / 1
10807	105	255	1.800	30,29	1-0-12 / 1

GLASS

Jarra cristal
Glass bottle
Bouteille en verre
Bottigliette
Glasflasche



REF.	Ø(mm)	H(mm)	ml	€	UE / MOQ
8395	95	270	1.000	2,93	1-0-12 / 1
8396	78	200	500	2,05	1-0-24 / 1

INOX STAINLESS STEEL 201

Jarra agua
Water jug
Carafe d'eau
Caraffa d'acqua
Wasserkaraffe



REF.	Ø(mm)	H(mm)	ml	€	UE / MOQ
3030	100	145	1.250	19,10	1-0-6 / 1

Pinza hielo

Ice tong
Pince à glaçon
Molla ghiaccio
Eiswürflzange



REF.	COLOR	L(mm)	€	UE / MOQ
6767	INOX MIRROR	190	6,48	1-10-100 / 1
6768	PVD BLACK SATIN	190	8,26	1-10-100 / 1
6769	PVD CHAMPAGNE SATIN	190	8,26	1-10-100 / 1
6770	PVD COPPER SATIN	190	8,26	1-10-100 / 1



Pinza servir

Serving tong
Pince à service
Molla arrosto
Servierzange



REF.	COLOR	L(mm)	€	UE / MOQ
6775	INOX MIRROR	240	7,14	1-10-100 / 1
6776	PVD BLACK SATIN	240	9,85	1-10-100 / 1
6777	PVD CHAMPAGNE SATIN	240	9,85	1-10-100 / 1
6778	PVD COPPER SATIN	240	9,85	1-10-100 / 1



Pinza pasteles

Cake tong
Pince à gâteau
Molla dolce
Gebäckzange



REF.	COLOR	L(mm)	€	UE / MOQ
6779	INOX MIRROR	240	7,14	1-10-100 / 1
6780	PVD BLACK SATIN	240	9,85	1-10-100 / 1
6781	PVD CHAMPAGNE SATIN	240	9,85	1-10-100 / 1
6782	PVD COPPER SATIN	240	9,85	1-10-100 / 1



Pinza Spaghetti

Spaghetti tong
Pince spaghetti
Molla spaghetti
Spahettizange



REF.	COLOR	L(mm)	€	UE / MOQ
6771	INOX MIRROR	240	7,14	1-10-100 / 1
6772	PVD BLACK SATIN	240	9,85	1-10-100 / 1
6773	PVD CHAMPAGNE SATIN	240	9,85	1-10-100 / 1
6774	PVD COPPER SATIN	240	9,85	1-10-100 / 1



PACKAGING
BLISTER



Espatula servir
 Serving spatula
 Spatule à service
 Spatula arrosto
 Servirspatel

REF.	COLOR	L(mm)	€	UE / MOQ
5259	BLACK	280	12,61	1-10-50 / 1
5262	COPPER	280	12,61	1-10-50 / 1
5265	CHAMPAGNE	280	12,61	1-10-50 / 1



Cazo sopa
 Soup ladle
 Louche à potage
 Mestolo sopa
 Suppenkelle

REF.	COLOR	L(mm)	€	UE / MOQ
5260	BLACK	265	17,16	1-10-50 / 1
5263	COPPER	265	17,16	1-10-50 / 1
5266	CHAMPAGNE	265	17,16	1-10-50 / 1

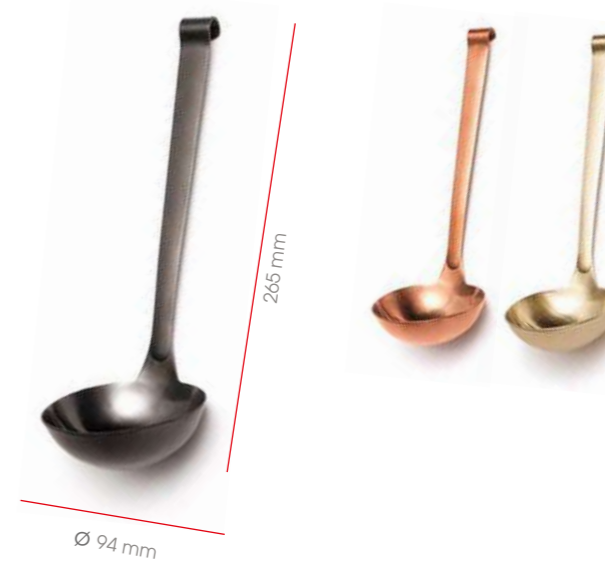

Cuchara servir
 Serving spoon
 Cuillère à servir
 Cucchiaino servir
 Servierlöffel

REF.	COLOR	L(mm)	€	UE / MOQ
5261	BLACK	300	12,69	1-10-50 / 1
5264	COPPER	300	12,69	1-10-50 / 1
5267	CHAMPAGNE	300	12,69	1-10-50 / 1





Bandeja reposa utensilio
Utensil rest tray
Plateau repos des ustensiles
Vassoi Riposo per l'utensile
Repository-Werkzeug tablett



REF.	W(mm)	L(mm)	H(mm)	€	UE / MOQ
7960	145	195	17	35,96	1-10-50 / 1
7889	110	155	12	31,04	1-10-50 / 1



PACKAGING
BLISTER



PACKAGING
BLISTER



REF.	Descripción	Lmm	PALA mm	€	UE/MOQ
A 6597	TENEDOR ENSALADA salad fork fourchette salade forchetta insalata salatgabel	250	60x85	9,54	1-10-50 / 1
B 6594	CUCHARA RANURADA slotted spoon cuillère à servir percée cucchiaio asolati skimmer	300	70x98	11,23	1-10-50 / 1
C 7116	ESPUMADERA skimer écumoire schiumarola schaumlöffel	320	Ø 100	16,50	1-10-50 / 1
D 6589	TENEDOR CARNE meat fork fourchette viande forchetta carne fleischgabel	300	35x90	8,59	1-10-50 / 1
E 6590	ESPÁTULA spatula spatule spatula spatel	280	82x100	10,94	1-10-50 / 1
F 6592	CUCHARA SPAGHETTI spaguetti spoon cuillère à spaghetti cucchiaio spaguetti spaghetti löffel	300	73x90	15,01	1-10-50 / 1
G 6595	PALA REPOSTERÍA cake server pelle à tarte pala torta gebäck schaufel	300	75x140	10,04	1-10-50 / 1

REF.	Descripción	Lmm	PALA mm	ml	€	UE/MOQ
H 6593	CUCHARA SERVIR serving spoon cuillère à servir cucchiaio servir servierlöffel	300	70x98		11,03	1-10-50 / 1
I 6599	CUCHARA ENSALADA salad spoon cuillère salade cucchiaio salate salatlöffel	250	60x85		9,54	1-10-50 / 1
J 7958	CAZO SALSAS sauce ladle cuillère à sauce mestolino salsa soßenkelle	295	Ø 60	30	17,21	1-10-50 / 1
K 6607	CAZO SALSAS sauce ladle cuillère à sauce mestolino salsa soßenkelle	260	Ø 60	30	15,53	1-10-50 / 1
L 7959	CUCHARA ARROZ rice spoon cuillère à riz cucchiaio riso reislöffel	355	75x100		14,14	1-10-50 / 1
M 6596	CUCHARA ARROZ rice spoon cuillère à riz cucchiaio riso reislöffel	280	75x100	30	10,54	1-10-50 / 1
N 6606	CAZO SOPA soup ladle louche à potage mestolo sopa suppenkelle	310	Ø 94	120	19,00	1-10-50 / 1
O 6591	CAZO SOPA soup ladle louche à potage mestolo sopa suppenkelle	265	Ø 94	120	16,00	1-10-50 / 1

INOX STAINLESS STEEL 201

Pinza servir PVC
 Serving PVC tong
 Pince à servir pvc
 Pinze da servizio pvc
 Vorlegezange pvc

REF.	L(mm)	€	UE / MOQ
2870	240	4,65	1-24-120 / 1



INOX STAINLESS STEEL 201

Pinza multiusos PVC
 Multiuse PVC tong
 Pince multi-usage
 Pinze multiuso
 Mehrzweckzange

REF.	L(mm)	€	UE / MOQ
2871	240	3,69	1-24-120 / 1
2872	300	4,31	1-24-120 / 1
2873	350	4,78	1-24-120 / 1



INOX STAINLESS STEEL 201

Pinza ensalada PVC
 Salad PVC tong
 Pince à salade pvc
 Pinze per insalata pvc
 Salatzange pvc

REF.	L(mm)	€	UE / MOQ
2867	240	4,45	1-24-120 / 1



INOX STAINLESS STEEL 201

Pinza buffet PVC
 Buffet PVC tong
 Pince à buffet pvc
 Pinze da buffet pvc
 Buffetzange pvc

REF.	L(mm)	€	UE / MOQ
2868	235	4,86	1-24-120 / 1



INOX STAINLESS STEEL 201

Pinza oval PVC
 Oval PVC tong
 Pince ovale pvc
 Pinze ovale pvc
 Ovalzange pvc

REF.	L(mm)	€	UE / MOQ
2869	240	4,59	1-24-120 / 1



INOX STAINLESS STEEL 201

Pinza luxe
 Luxe tong
 Pince luxe
 Pinze luxe
 Zange luxe

REF.	L(mm)	€	UE / MOQ
2874	240	6,15	1-24-120 / 1
2875	300	6,85	1-24-120 / 1
2876	350	7,70	1-24-120 / 1



Sistema de bloqueo para mantener la pinza cerrada.

Block system to keep closed the tong.

Pinza hielo muelle inox
 Spring ice tong
 Pince glaçon à ressort
 Molla ghiaccio
 Eiswürfelzange

REF.	L(mm)	€	UE / MOQ
3476	190	2,53	1-0-102 / 1



Pinza servir
 Serving tong
 Pince de service
 Molla arrosto
 Servierzange

REF.	L(mm)	€	UE / MOQ
2151	245	4,76	1-24-120 / 1



Pinza servir extra
 Serving extra tong
 Pince à servir extra
 Pinze da servizio extra
 Vorlegezange extra

REF.	L(mm)	€	UE / MOQ
0065	240	14,55	0-10-25 / 1



Punta ondulada que asegura una mejor sujeción de los alimentos

Curled tip ensures a better fastening for the foods.

Pinza multiusos extra
 Multiuse extra tong
 Pince multi-usage extra
 Pinze multiuso extra
 Mehrweckzange extra

REF.	L(mm)	€	UE / MOQ
2877	240	2,33	1-24-120 / 1
2878	300	2,73	1-24-120 / 1
2879	350	2,97	1-24-120 / 1



Pinza ensalada muelle
 Salad spring tong
 Pince salade
 Molla salate
 Salatzange

REF.	L(mm)	€	UE / MOQ
5654	240	4,46	1-0-100 / 1



Pinza repostería extra
 Pastry extra tong
 Pince à pâtisserie extra
 Molla dolce extra
 Gebäckzange extra

REF.	L(mm)	€	UE / MOQ
0066	240	13,36	0-10-25 / 1



BUFFET



PVC aislante para una mejor sujeción.

PVC insulator for a better clamping.

Estas pinzas monobloc fabricadas en acero inoxidable son funcionales tanto en buffet como en cocina. Su mango de PVC en distintos colores permite controlar la contaminación cruzada de los alimentos.

These monobloc tongs in stainless steel are just as functional for service at a buffet as in the kitchen. Their distinctively coloured PVC handles makes it easy to control cross-contamination between different foods.

INOX
STAINLESS
STEEL
201

PVC

2
MEDIDAS
SIZES



REF.	COLOR	L _(mm)	€	UE / MOQ
10677	○	250	3,56 €	1-10-100 / 1
10678	●	250	3,56 €	1-10-100 / 1
10684	●	250	3,56 €	1-10-100 / 1
10685	●	250	3,56 €	1-10-100 / 1
10686	●	250	3,56 €	1-10-100 / 1
10687	●	250	3,56 €	1-10-100 / 1
10688	●	250	3,56 €	1-10-100 / 1
10701	○	300	4,20 €	1-10-100 / 1
10702	●	300	4,20 €	1-10-100 / 1
10703	●	300	4,20 €	1-10-100 / 1
10704	●	300	4,20 €	1-10-100 / 1
10705	●	300	4,20 €	1-10-100 / 1
10706	●	300	4,20 €	1-10-100 / 1
10707	●	300	4,20 €	1-10-100 / 1



LOGÍSTICA

RACKS

- 434 CESTAS Y EXTENDERS
- 436 MONTADOS
- 438 COMPLEMENTOS

CONTENEDORES ISOTÉRMICOS

THERMOBOX

- 440 CARGADOR FRONTAL
- 441 CONTENEDORES

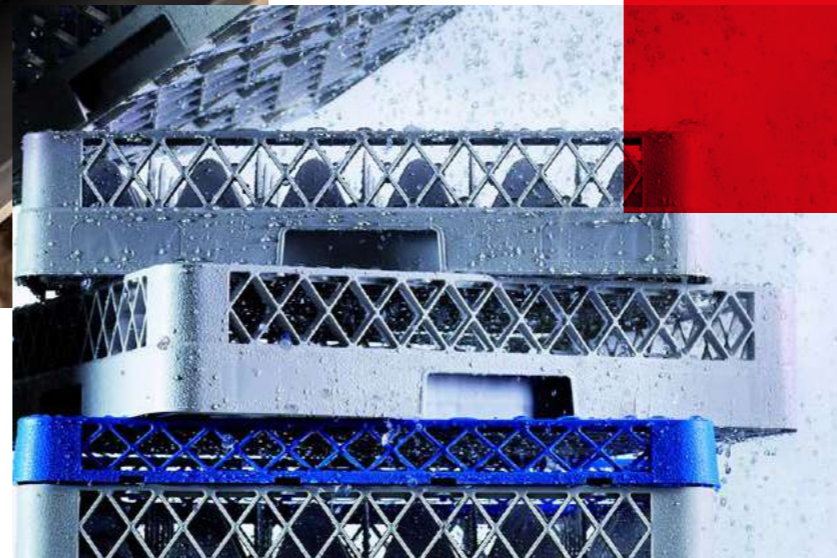



Racks industriales robustos para lavar, almacenar y transportar cualquier tipo de plato, vaso, copa, cubtería, etc.

El borde superior y la forma de los fondos están hechos para apilarlos de forma fácil y firme.

Los extensores permiten alcanzar la altura ideal para el almacenamiento y lavado.

Robust industrial racks for washing, storing and transporting any type of plate, glass, cup, glassware, cutlery, etc.

The top edge and the shape of the bottoms are made for easy and firm stacking.

The extenders allow to reach the ideal height for storage and washing.



Fabricado en PP de alta calidad, apto para contacto alimentario, el mejor material contra productos químicos y altas temperaturas (hasta 100°C)

Made of high quality PP, suitable for food contact, the best material against chemicals and high temperatures (up to 100°C)

Rejillas abiertas para un perfecto lavado y secado

Open grids for perfect washing and drying

Las asas y las esquinas redondeadas, lo hacen seguro y fácil de manejar

Easily to handle four sides.

El borde superior y la forma de los fondos están hechos para apilarlos de forma fácil y firme

The top edge and the shape of the bottoms are made for easy and firm stacking

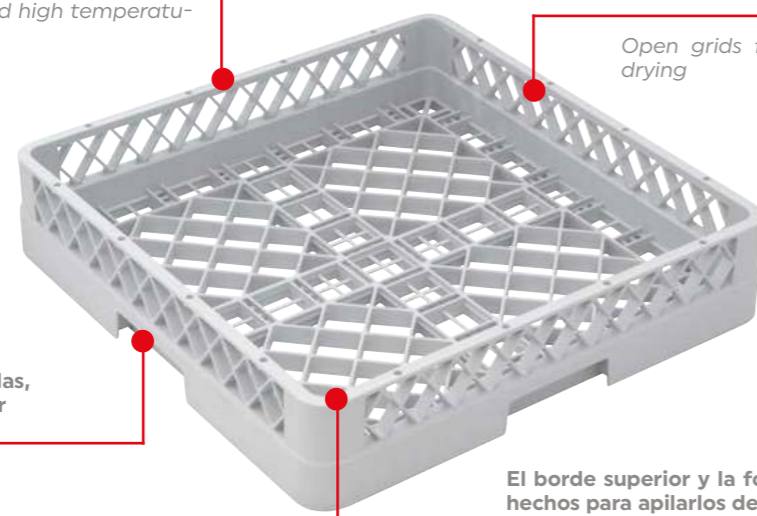

Racks.

Cesta de lavado universal

Universal rack
Universal rack
Rack universale
Universal rack



REF.	MEDIDA EXTERNA		MEDIDA EXTERNA		€	UE / MOQ
	W(mm)	L(mm)	W(mm)	L(mm)		
11039	500	500	476	476	21,98	1-0-6 / 1

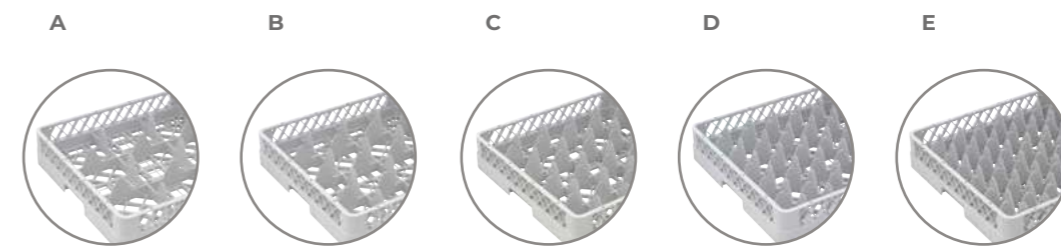

Cesta de lavado compartimento / Rack compartiment / Rack compartiment / Rack scomparto / Rack fächer

REF.	MEDIDA EXTERNA		MEDIDA EXTERNA		COMPARTIMENTOS	€	UE / MOQ
	W(mm)	L(mm)	W(mm)	L(mm)			
A 11040	500	500	151	151	9	23,55	1-0-6-0-0 / 1
B 11041	500	500	115	115	16	25,90	1-0-6-0-0 / 1
C 11042	500	500	88	88	25	27,48	1-0-6-0-0 / 1
D 11043	500	500	73	73	36	29,44	1-0-6-0-0 / 1
E 11044	500	500	62	62	49	31,40	1-0-6-0-0 / 1

Extender universal

Universal extender
Universal extender
Extender universale
Universal extender



REF.	MEDIDA EXTERNA		MEDIDA EXTERNA		€	UE / MOQ
	W(mm)	L(mm)	W(mm)	L(mm)		
11048	500	500	476	476	9,81	1-0-12 / 1

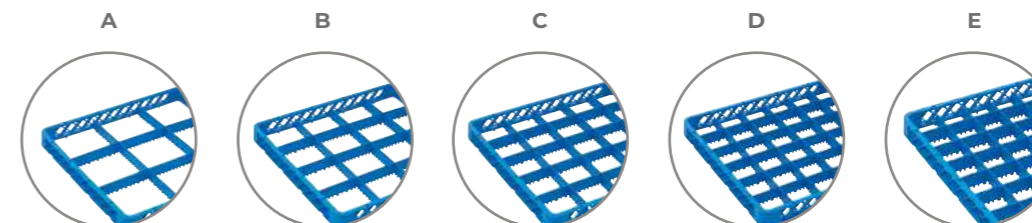

Extender compartimentos / Extender compartiment / Extender compartimen / Extender scomparto / Extender fächer

REF.	MEDIDA EXTERNA		MEDIDA EXTERNA		COMPARTIMENTOS	€	UE / MOQ
	W(mm)	L(mm)	W(mm)	L(mm)			
A 11049	500	500	151	151	9	10,99	1-0-12 / 1
B 11050	500	500	115	115	16	10,99	1-0-12 / 1
C 11051	500	500	88	88	25	11,78	1-0-12 / 1
D 11052	500	500	73	73	36	11,78	1-0-12 / 1
E 11053	500	500	62	62	49	12,56	1-0-12 / 1



GUÍA DE MEDIDAS / GUIDE TO MEASURE

4 EXT. 256 mm

3 EXTENDERS. 214 mm

2 EXTENDERS. 172 mm

1 EXTENDER. 130 mm

BASE RACK. 88 mm

- **Monta tu propia altura según tus necesidades.**
Set your own height according to your needs.

- **Fácil sistema de montaje y que permite adaptar los racks a tus productos.**
Easy assembly system that allows you to adapt the racks to your products.

- **Se pueden añadir tantos suplementos como se desee.**
You can add as many supplements as you wish.

- **Una vez montados no se pueden desmontar.**
Once assembled, they cannot be disassembled.

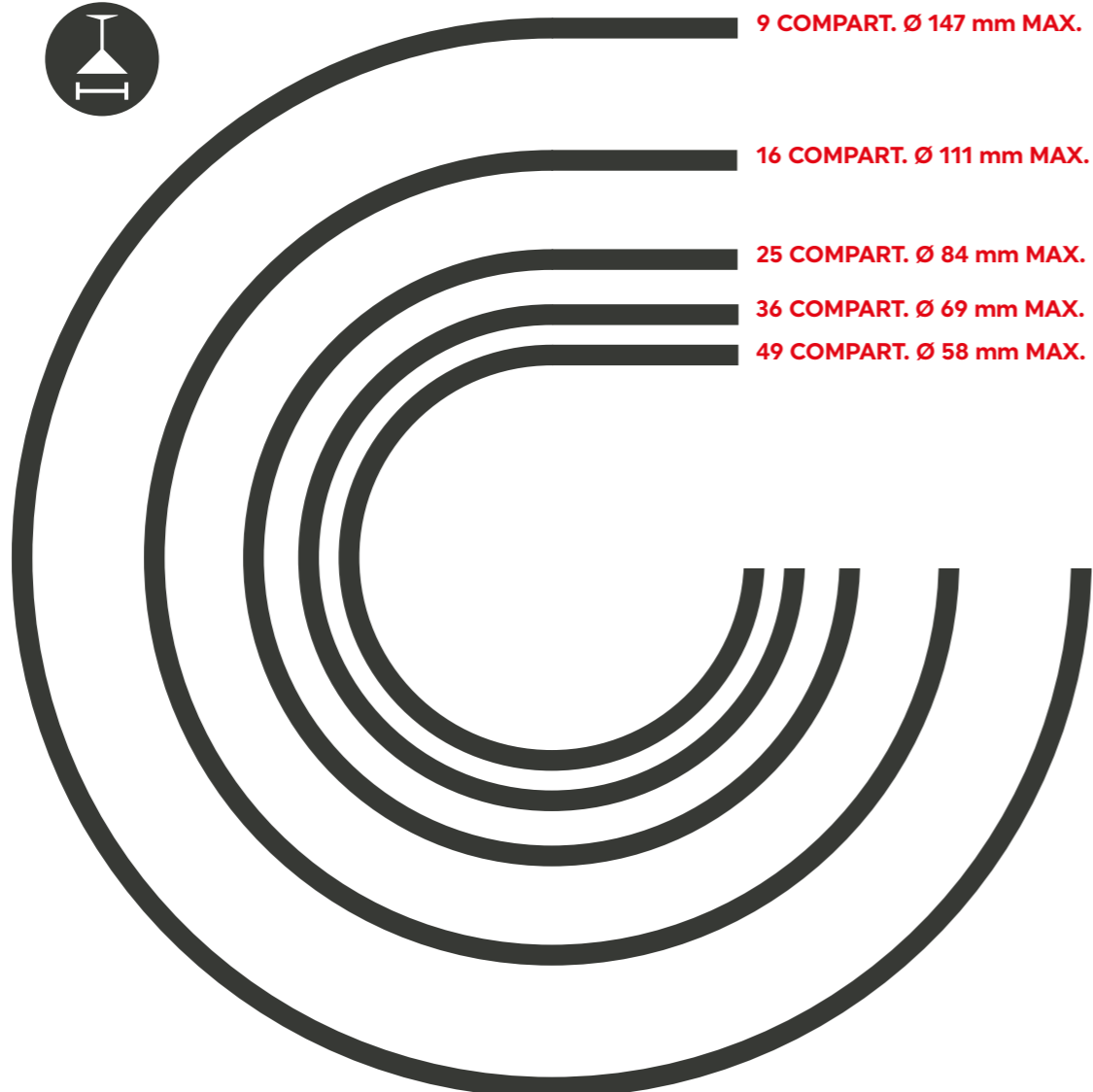
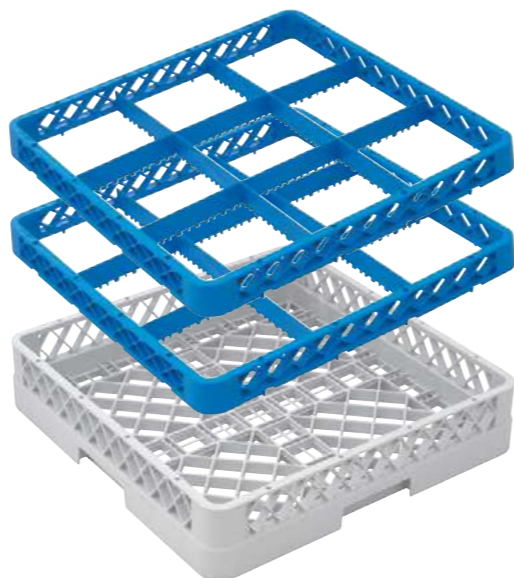

100°C



Ø 147mm MAX.

PACK cestas de lavado

9 compartimentos

PACK rack 9 compartment

PACK rack 9 compartment

PACK rack 9 scomparto

PACK rack 9 fächer



REF.	EXTENDER	H(mm)	€	UE / MOQ
11145	+1	130	34,53	1
11146	+2	172	45,52	1
11147	+3	214	56,51	1
11148	+4	256	67,50	1
11149	+5	298	78,48	1



Ø 111mm MAX.

PACK cestas de lavado

16 compartimentos

PACK rack 16 compartment

PACK rack 16 compartment

PACK rack 16 scomparto

PACK rack 16 fächer



REF.	EXTENDER	H(mm)	€	UE / MOQ
11150	+1	130	36,89	1
11151	+2	172	47,88	1
11152	+3	214	58,86	1
11153	+4	256	69,85	1
11154	+5	298	80,84	1



Ø 84mm MAX.

PACK cestas de lavado

25 compartimentos

PACK rack 25 compartment

PACK rack 25 compartment

PACK rack 25 scomparto

PACK rack 25 fächer



REF.	EXTENDER	H(mm)	€	UE / MOQ
11155	+1	130	39,26	1
11156	+2	172	51,04	1
11157	+3	214	62,82	1
11158	+4	256	74,60	1
11159	+5	298	86,38	1



Ø 69mm MAX.

PACK cestas de lavado

36 compartimentos

PACK rack 36 compartment

PACK rack 36 compartment

PACK rack 36 scomparto

PACK rack 36 fächer



REF.	EXTENDER	H(mm)	€	UE / MOQ
11160	+1	130	41,22	1
11161	+2	172	53,00	1
11162	+3	214	64,78	1
11163	+4	256	76,56	1
11164	+5	298	88,34	1



Ø 58mm MAX.

PACK cestas de lavado

49 compartimentos

PACK rack 49 compartment

PACK rack 49 compartment

PACK rack 49 scomparto

PACK rack 49 fächer



REF.	EXTENDER	H(mm)	€	UE / MOQ
11165	+1	130	43,96	1
11166	+2	172	56,52	1
11167	+3	214	69,07	1
11168	+4	256	81,63	1
11169	+5	298	94,18	1

Pack 10 clips para cestas

Pack 10 rack clip

Pack 10 rack clip

Pack 10 rack clip

Pack 10 rack clip



REF.	COLOR	W(mm)	L(mm)	€	UE / MOQ
11059	○	20	0,7	9,12	1-0-100 / 1
11060	●	20	0,7	9,12	1-0-100 / 1
11061	●	20	0,7	9,12	1-0-100 / 1
11062	●	20	0,7	9,12	1-0-100 / 1
11063	●	20	0,7	9,12	1-0-100 / 1
11064	●	20	0,7	9,12	1-0-100 / 1
11065	●	20	0,7	9,12	1-0-100 / 1



Cesta de lavado para cubertería
Rack for cutlery
Rack pour les couverts
Rack per posate
Rack für besteck



REF.	W(mm)	L(mm)	€	UE / MOQ
11045	500	500	21,57	1-0-6 / 1

Cesta de lavado para bandejas
Rack for trays
Rack pour plateaux
Rack per vassoi
Rack für tablett



REF.	W(mm)	L(mm)	€	UE / MOQ
11046	500	500	21,98	1-0-6 / 1

Cesta de lavado para vajilla
Rack for plates
Rack pour les plats
Rack per piatti
Rack für teller



REF.	W(mm)	L(mm)	€	UE / MOQ
11047	500	500	21,98	1-0-6 / 1

Tapa para cesta de lavado
Rack lid
Rack couvercle
Rack coperchio
Rack deckel



REF.	W(mm)	L(mm)	€	UE / MOQ
11076	500	500	17,01	1-0-35 / 1

Cesta para cubertería
Rack for cutlery
Rack pour les couverts
Rack per posate
Rack für besteck



REF.	W(mm)	L(mm)	COMPART.	€	UE / MOQ
11055			1	4,86	1-0-150 / 1
11054	430	205	8	14,14	1-0-10 / 1

Asa para cesta cubertería
Handle for rack for cutlery
Poignée pour rack pour les couverts
Manico per rack per posate
Griff für rack für besteck



REF.	W(mm)	L(mm)	€	UE / MOQ
11079	500	500	2,75	1-0-20 / 1

Carro para cesta de lavado sin asa
Rack trolley without handle
Rack chariot sans poignée
Rack carrello senza maniglia
Rack wagen ohne griff



REF.	W(mm)	L(mm)	€	UE / MOQ
11077	500	500	122,33	1-0-10 / 1

Carro para cesta de lavado con asa
Rack trolley with handle
Rack chariot avec poignée
Rack carrello con maniglia
Rack wagen mit griff



REF.	W(mm)	L(mm)	€	UE / MOQ
11078	500	500	188,74	1-0-10 / 1



INOX
STAINLESS
STEEL
201

Carro Racks Alto
Rack Trolley High
Chariot À Rack Élevé
Carrello Rack Alto
Hoher Tablettwagen Für

REF.	W(mm)	L(mm)	H(mm)	CAPACIDAD	€	UE / MOQ
11773	560	510	1735	7	227,07	1-0-1 / 1



Especial para lavavajillas de barra.
Specially for countertop dishwashers

Rack 35,5 x 35,5
Rack
Rack
Rack
Rack



REF.	W(mm)	L(mm)	H(mm)	€	UE / MOQ
11616	355	355	150	18,54	1-0-9 / 1

Rack 40 x 40
Rack
Rack
Rack
Rack



REF.	W(mm)	L(mm)	H(mm)	€	UE / MOQ
11617	400	400	150	20,06	1-0-8 / 1

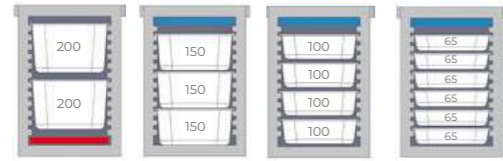

Contenedor isotérmico carga frontal GN 93-12

Thermobox frontloader GN 93-12
 Conteneur isotherme à ouverture frontal GN 93-12
 Contenitore isothermico per carico frontale GN 93-12
 Thermobox frontlader GN 93-12



CIERRE METÁLICO REFORZADO
REINFORCED METAL LOCKING

REF.	COLOR	MEDIDAS EXTERIORES			MEDIDAS INTERIORES			CARRILES (mm)	V (litros)	€	UE / MOQ
		W(mm)	L(mm)	H(mm)	W(mm)	L(mm)	H(mm)				
10416	●	440	645	625	335	530	525	12 - 32	93	413,15	1



Contenedor isotérmico carga frontal GN 69-9

Thermobox frontloader GN 69-9
 Conteneur isotherme à ouverture frontal GN 69-9
 Contenitore isothermico per carico frontale GN 69-9
 Thermobox frontlader GN 69-9



REF.	COLOR	MEDIDAS EXTERIORES			MEDIDAS INTERIORES			CARRILES (mm)	V (litros)	€	UE / MOQ
		W(mm)	L(mm)	H(mm)	W(mm)	L(mm)	H(mm)				
10417	●	450	660	490	335	530	390	9 - 38	69	246,22	1



Set Rueda + Base

Wheels + Base Set
 Kit Roue + Base
 Set Ruota+ Base
 Set Rad + Base



REF.	W(mm)	L(mm)	H(mm)	€	UE / MOQ
11762	400	600	180	183,54	1



Set Rueda + Base

Wheels + Base Set
 Kit Roue + Base
 Set Ruota+ Base
 Set Rad + Base



REF.	W(mm)	L(mm)	H(mm)	€	UE / MOQ
11763	400	600	180	199,65	1

Calentamiento en el horno (max. 30min a 85°C) y baño maría (max. 30min).

Heating in the oven (max. 30min at 85°C), microwave and bain-marie (max. 30min).



GN SIZE

Placa de calor

Hot Pack
 Plaque chauffante
 Piastra riscaldante
 Wärme-akku

REF.	W(mm)	L(mm)	H(mm)	€	UE / MOQ
10423	325	530	25	165,09	1

Refrigeración en el congelador (max. -12°C).

Cooling in the freezer (max. -12°C).



GN SIZE

Placa de frío

Cold pack
 Plaque eutectique
 Piastra eutetica
 Kühl-akku

REF.	W(mm)	L(mm)	H(mm)	€	UE / MOQ
10424	325	530	25	107,91	1



10409



10410



10411



10412



10413

GN SIZE

Contenedor isotérmico GN 1/1 PREMIUM

Thermobox GN 1/1 PREMIUM
 Conteneur isotherme GN 1/1 PREMIUM
 Contenitore isothermico GN 1/1 PREMIUM
 Thermobox GN 1/1 PREMIUM

REF.	MEDIDAS EXTERIORES			MEDIDAS INTERIORES			V (litros)	€	UE / MOQ
	W(mm)	L(mm)	H(mm)	W(mm)	L(mm)	H(mm)			
10409	400	600	180	337	538	117	21	72,68	1
10410	400	600	230	337	538	167	30	75,63	
10411	400	600	280	337	538	217	39	79,22	
10412	400	600	320	337	538	257	46	82,91	
10413	400	600	400	337	538	337	61	109,75	



GN SIZE



Contenedor isotérmico GN 1/1 DELUXE

Thermobox GN 1/1 DELUXE
 Conteneur isotherme GN 1/1 DELUXE
 Contenitore isothermico GN 1/1 DELUXE
 Thermobox GN 1/1 DELUXE

REF.	MEDIDAS EXTERIORES			MEDIDAS INTERIORES			V (litros)	€	UE / MOQ
	W(mm)	L(mm)	H(mm)	W(mm)	L(mm)	H(mm)			
10414	400	675	290	325	535	215	37	97,38	1
10415	400	675	335	325	535	260	45	112,47	

GN / CARGADOR FRONTAL
GN / FRONTLOADER



Cooling Top Gn 1/1 Premium

Cooling Top Gn 1/1 Premium
 Plaque Réfrigérante Gn 1/1 Premium
 Piano Di Raffreddamento Gn 1/1 Premium
 Gn-Kühlaufsatz 1/1 Premium

REF.	W(mm)	L(mm)	H(mm)	€	UE / MOQ
11764	400	600	180	58,55	1



Cooling Top Gn 1/1 Deluxe

Cooling Top Gn 1/1 Deluxe
 Plaque Réfrigérante Gn 1/1 Deluxe
 Piano Di Raffreddamento Gn 1/1 Deluxe
 Gn-Kühlaufsatz 1/1 Deluxe

REF.	W(mm)	L(mm)	H(mm)	€	UE / MOQ
11765	400	600	180	72,86	1



GN
SIZE

Contenedor isotérmico BOXER
Thermobox BOXER
Conteneur isotherme BOXER
Contentitore isothermico BOXER
Thermobox BOXER



REF.	MEDIDAS EXTERIORES			MEDIDAS INTERIORES			V (litros)	€	UE / MOQ
	W(mm)	L(mm)	H(mm)	W(mm)	L(mm)	H(mm)			
10422	395	595	290	340	540	230	42	58,22	1

Tamaño cuadrado optimizado. Con asas empotradas y tapa hermética.
Para recipientes GN 2/3, pizza o pasteles.

Optimized square size. With recessed grips, tight fitting lid.
For containers GN 2/3, pizza or cakes.

GN
SIZE

Contenedor isotérmico pizza BOXER
Thermobox pizza BOXER
Conteneur isotherme pizza BOXER
Contentitore isothermico pizza BOXER
Thermobox pizza BOXER



REF.	MEDIDAS EXTERIORES			MEDIDAS INTERIORES			V (litros)	€	UE / MOQ
	W(mm)	L(mm)	H(mm)	W(mm)	L(mm)	H(mm)			
10421	400	415	265	350	365	210	27	57,38	1

Contenedor isotérmico ALLROUND 60/40
Thermobox ALLROUND 60/40
Conteneur isotherme ALLROUND 60/40
Contentitore isothermico ALLROUND 60/40
Thermobox ALLROUND 60/40



REF.	MEDIDAS EXTERIORES			MEDIDAS INTERIORES			V (litros)	€	UE / MOQ
	W(mm)	L(mm)	H(mm)	W(mm)	L(mm)	H(mm)			
10418	485	660	260	425	625	200	53	100,53	1
10419	485	685	360	425	625	300	80	126,36	1

Contenedor isotérmico SHOPPING
Thermobox SHOPPING
Conteneur isotherme SHOPPING
Contentitore isothermico SHOPPING
Thermobox SHOPPING



REF.	COLOR	MEDIDAS EXTERIORES			MEDIDAS INTERIORES			FORMATO	V (litros)	€	UE / MOQ
		W(mm)	L(mm)	H(mm)	W(mm)	L(mm)	H(mm)				
10420	●	285	360	365	220	300	310	GN 1/4	20	73,32	1



- **Base llana y robusta de 350 x 350 mm sin bordes.**
Sturdy, flat base 350 x 350 mm without edges.
- **Cierre seguro.**
Secure locking.
- **Superficie antideslizante.**
Non-slip surface.



- **Apilable con otros contenedores.**
Stackable with other containers.
- **Sistema de bloqueo en la base.**
Locking system at the base.

Cake Box
Cake Box
Boîte À Gâteau
Scatola Per Torta
Kuchenvitrine

REF.	MEDIDAS EXTERIORES			MEDIDAS INTERIORES			V (litros)	€	UE / MOQ
	W(mm)	L(mm)	H(mm)	W(mm)	L(mm)	H(mm)			
11766	400	415	280	350	350	175	21	72,86	1

Extender Cake Box
Extender Cake Box
Extension Boîte À Gâteau Noir
Estensore Per Scatola Torta
Erweiterung Kuchenvitrine



REF.	MEDIDAS EXTERIORES			MEDIDAS INTERIORES			€	UE / MOQ
	W(mm)	L(mm)	H(mm)	W(mm)	L(mm)	H(mm)		
11767	410	410	135	350	350	120	45,65	1

Custom Packs

MAZOS

- GRANADA / BAGUETTE
- CUBA / LUNA
- MADRID / BARCELONA / MUNICH
- VIENA / LONDON
- BILBAO / INGLES / MALVARROSA
- MIA / ONLINE / CHEESE
- IBIZA / OSLO / HIDRAULIC / NICE
- HOTEL / ALIDA / CANADA
- SEVILLA / CHEF / NORTH



1



10



2



3



4



11



12



5



6



7



13



8



9

1. MAZOS Para cuchillos, cucharas y tenedores 2. CAJA 12 UNIDADES PVC Box 12 units PVC 3. BLISTER CHULETEROS Blister knives 4. BLISTER 4 PIEZAS FINGER FOOD Blister 4 units Finger Food 5. BLISTER CARTÓN COMAS Blister Comas 6. CAJA 12 UNIDADES VENTANA Box 12 units window 7. CAJA 12 UNIDADES VENTANA KRAFT Box 12 units windows kraft 8. CAJA 6 CHULETEROS MADERA Wood box 6 steak knife 9. CAJA 6 CHULETEROS KRAFT Kraft box 6 steak knife 10. CAJA 12 UNIDADES Box 12 units 11. CAJA 16 , 24 Y 30 UNIDADES COMAS Comas Box 16, 24 and 30 units 12. CAJA 16 , 24 Y 30 UNIDADES COMAS AUTOR Comas Autor Box 16, 24 and 30 units 13. ESTUCHE 24 PIEZAS MADERA 24 pieces wooden pack.

NEW

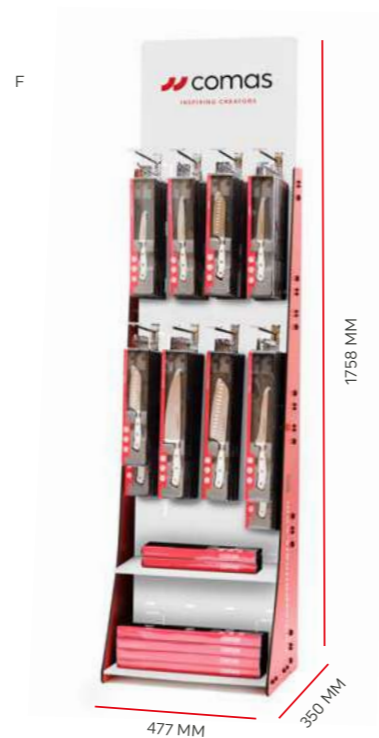

	€	mm	mm	mm	mm
A 7531 MUEBLE EXPOSITOR DOCENAS COMAS hospitality dozen comas display stand	782,46 €	1200	320	1850	4 COLEC. 1 MASTER POR REF
B 5565 MUEBLE EXPOSITOR HOSTELERÍA horeca stand	838,00 €	1280	320	1823	5 COLEC. 1 MASTER POR REF
C 5564 MUEBLE EXPOSITOR BLISTER LACASA blister Lacasa stand white	264,11 €	480	430	2100	3 COLEC. + 27 REFERENCIAS
D 6792 MUEBLE EXPOSITOR MENAJE kitchenware stand	268,04 €	675	360	2136	4 COLEC. 1 MASTER POR REF
E 5650 MUEBLE EXPOSITOR MADERA wood stand	829,04 €	542	560	1700	3 COLEC. 4 INNER POR REF
F 1884 MUEBLE EXPOSITOR MADERA CUCHILLOS wooden knives display furniture, mobilier de présentation de couteaux en bois, mobile espositore coltelli in legno, holzmesser ausstellungsmöbel	486,39 €	477	360	1758	

A 1881 MUEBLE EXPOSITOR MADERA MENAJE wooden exhibitor furniture kitchenware, exposant en bois meubles cuisine, esposito- re in legno mobile articoli da cucina, ausstellermöbel aus holz küchengeräte	530,60 €	801	450	2137	
---	----------	-----	-----	------	--



G



H



I



J



A



B



C



D



E

	€	mm	mm	COLEC.	PIEZAS
G 5570 EXPOSITOR SOBREMESA COMAS counter display, présentoir 4 pièces, espositore da tavola, besteck-präsentations-ständer klein	31,30 €	235	320	1 COLEC.	4 PIEZAS
H 5571 EXPOSITOR SOBREMESA CUCHILLOS totem display stand, présentoir totem mobile, espositore totem, besteck-präsentations-ständer groß	54,76 €	400	330	1 COLEC.	7 PIEZAS
I 5648 EXPOSITOR BANDEROLA COMAS comas flag display stop rayon, comas espositore a bandiera, comas fahnen-besteck-display	54,76 €	440	270	1 COLEC.	4 PIEZAS
J 5646 MUEBLE EXPOSITOR TOTEM COMAS totem display stand, présentoir totem, mobile espositore, totem besteck-präsentations-ständer groß	333,29 €	301	1869	8-16 COLEC.	32-64 PIEZAS

A 7824 BASE MUEBLE EXPOSITOR NEGRO COMAS AUTOR comas autor display stand	711,33€	720	1600	1 COLEC. 1 MASTER POR REF
A 7597 TABLERO EXPOSITOR MUEBLE MADERA COMAS black wooden display stand comas autor	25,64 €			
B 7780 AUTOR black wooden display stand lab	25,64 €			
C 7781 TABLERO EXPOSITOR MUEBLE MADERA LAB black wooden display stand comas kodai	25,64 €			
D 7782 TABLERO EXPOSITOR MUEBLE MADERA KODAI black wooden display stand sakura	25,64 €			
E 7888 TABLERO EXPOSITOR MUEBLE MADERA SAKURA black wooden display stand steak knives	25,64 €			
TABLERO EXPOSITOR MADERA CHULETERO HQ				

Índice referencia / Reference index

REF.	PAG.	REF.	PAG.	REF.	PAG.	REF.	PAG.	REF.	PAG.	REF.	PAG.	REF.	PAG.	REF.	PAG.	REF.	PAG.
9984	48	10110	346	10197	381	10269	383	10621	387	10701	430	10934	323	11013	185	11143	412
9985	281	10111	346	10199	381	10270	383	10622	387	10702	430	10935	323	11014	389	11144	412
9986	281	10112	346	10200	381	10271	383	10630	388	10703	430	10936	323	11015	389	11145	437
9987	281	10113	346	10201	381	10272	383	10632	388	10704	430	10937	322	11016	282	11146	437
9988	281	10114	345	10203	381	10273	383	10633	388	10705	430	10938	322	11017	282	11147	437
9989	281	10115	345	10205	381	10409	441	10634	388	10706	430	10939	322	11018	208	11148	437
9990	281	10116	345	10206	381	10410	441	10635	388	10707	430	10940	322	11019	208	11149	437
9993	403	10117	345	10207	381	10411	441	10636	388	10715	402	10941	322	11022	330	11150	437
9994	403	10118	347	10209	381	10412	441	10637	388	10716	402	10942	322	11023	330	11151	437
9995	402	10119	346	10210	381	10413	441	10638	388	10719	281	10943	322	11024	330	11152	437
9996	367	10120	346	10211	381	10414	441	10639	388	10720	281	10944	323	11029	357	11153	437
9997	402	10121	346	10212	381	10415	441	10640	388	10784	413	10957	395	11030	357	11154	437
10022	320	10122	346	10213	381	10416	440	10641	388	10785	412	10958	246	11031	357	11155	437
10027	320	10123	346	10214	382	10417	440	10642	139	10786	413	10959	246	11032	357	11156	437
10028	320	10124	347	10215	382	10418	442	10643	139	10788	249	10960	246	11033	357	11157	437
10029	320	10125	347	10216	382	10419	442	10644	139	10789	249	10961	246	11034	357	11158	437
10030	320	10126	347	10217	382	10420	443	10645	139	10791	249	10963	321	11035	358	11159	437
10039	320	10127	347	10218	382	10421	442	10646	139	10792	249	10964	339	11038	355	11160	437
10044	320	10128	345	10219	382	10422	442	10647	139	10793	249	10965	339	11039	435	11161	437
10045	320	10129	345	10220	382	10423	440	10648	281	10794	249	10966	339	11040	435	11162	437
10046	321	10130	345	10221	382	10424	440	10649	281	10799	413	10967	337	11041	435	11163	437
10047	321	10131	345	10222	382	10431	39	10650	375	10800	413	10968	339	11042	435	11164	437
10048	321	10141	381	10223	382	10432	380	10651	375	10801	413	10969	339	11043	435	11165	437
10051	321	10142	381	10224	382	10566	385	10652	375	10803	405	10970	339	11044	435	11166	437
10053	321	10143	381	10225	382	10567	385	10653	375	10804	405	10971	216	11045	438	11167	437
10074	345	10144	381	10226	382	10568	385	10654	375	10806	422	10972	214	11046	438	11168	437
10075	345	10145	381	10227	382	10569	385	10655	375	10807	422	10973	216	11047	438	11169	437
10076	345	10146	381	10228	382	10570	385	10656	375	10808	413	10974	216	11048	435	11170	281
10077	345	10147	380	10230	382	10571	385	10657	375	10811	320	10975	413	11049	435	11171	281
10078	347	10148	380	10231	382	10572	385	10658	375	10832	139	10976	413	11050	435	11172	281
10079	346	10149	380	10232	382	10573	385	10659	375	10833	139	10977	413	11051	435	11173	281
10080	346	10150	380	10233	382	10574	385	10668	245	10834	139	10978	413	11052	435	11174	281
10081	346	10151	380	10234	382	10575	385	10669	245	10835	140	10979	41	11053	435	11175	281
10082	346	10153	380	10235	382	10576	385	10670	245	10836	140	10980	41	11054	438	11176	281
10083	346	10154	380	10236	382	10577	385	10671	245	10837	140	10981	41	11055	438	11177	281
10084	347	10155	381	10237	382	10578	385	10672	246	10838	140	10982	41	11058	406	11178	281
10085	347	10157	381	10238	382	10579	385	10673	246	10839	385	10983	41	11059	437	11179	281
10086	347	10159	381	10239	382	10580	385	10674	247	10861	400	10984	41	11060	437	11180	281
10087	347	10160	381	10240	382	10581	385	10675	247	10862	400	10985	41	11061	437	11181	281
10088	345	10161	381	10241	382	10582	385	10676	247	10863	143	10986	41	11062	437	11482	395
10089	345	10162	381	10242	382	10583	385	10677	430	10879	245	10987	41	11063	437	11484	393
10090	345	10164	380	10243	383	10584	385	10678	430	10880	245	10988	41	11064	437	11485	393
10091	345	10166	380	10245	383	10585	385	10679	403	10881	245	10988	41	11065	437	11486	394
10092	346	10168	380	10247	383	10586	385	10680	403	10882	245	10989	41	11066	395	11487	394
10093	345	10170	380	10249	383	10587	385	10681	403	10883	246	10989	41	11067	208	11488	394
10094	345	10172	380	10251	383	10588	385	10682	403	10884	246	10990	224	11068	208	11489	393
10095	345	10173	380	10253	383	10589	385	10683	403	10885	247	10991	224	11069	208	11490	393
10096	345	10175	381	10255	383	10590	385	10684	430	10886	247	10992	224	11070	208	11491	393
10097	347	10176	381	10256	383	10591	387	10685	430	10887	247	10993	224	11071	208	11492	393
10098	346	10177	381	10257	383	10592	387	10686	430	10897	313	10994	201	11072	208	11493	394
10099	346	10179	380	10258	383	10593	387	10687	430	10898	313	10997	195	11076	438	11494	394
10100	346	10181	380	10259	383	10594	387	10688	430	10899	313	10998	282	11077	438	11495	394
10101	346	10183	380	10260	383	10595	387	10689	397	10908	290	10999	282	11078	438	11572	283
10102	346	10185	380	10261	383	10596	387	10690	397	10909	290	11000	282	11079	438	11573	283
10103	347	10187	380	10262	383	10612	388	10691	397	10910	290	11001	282	11083	335	11574	282
10104	345	10188	380	10263	383	10614	388	10692	397	10928	139	11002	283	11084	335	11575	282
10105	345	10190	380	10264	383	10615	388	10693	397	10929	139	11003	283	11085	335	11576	282
10106	345	10192	380	10265	383	10617	387	10694	397	10930	139	11004	283	11086	335	11577	282
10107	345	10194	380	10266	383	10618	387	10698	397	10931	139	11005	283	11087	335	11578	393
10108	347	10195	380	10267	383	10619	387	10699	397	10932	139	11006	283	11088	335	11579	393
10109	346	10196	380	10268	383	10620	387	10700	397	10933	139	11007	283	11089	380	11580	393

Índice referencia / Reference index

REF.	PAG.	REF.	PAG.	REF.	PAG.	REF.	PAG.	REF.	PAG.	REF.	PAG.	REF.	PAG.	REF.	PAG.	REF.	PAG.
11738	359	11821	401	11962	186	12050	213	12129	310	12244	238	12419	236	M2715	154	MO18BJ21	260
11748	360	11822	401	11963	186	12069	145	12130	310	12268	241	12420	236	M2716	154	MO18BJ23	260
11756	351	11825	401	11965	293	12070	145	12131	310	12269	241	12421	236	M2759	152	MO18BJ27	260
11758	351	11826	401	11966	292	12071	145	12132	310	12270	241	12422	237	M2760	152	NE11AP21	265
11759	303	11827	361	11967	292	12072	145	12133	310	12271	241	12423	237	M2761	152	NE11AP30	265
11759	303	11905	380	11968	292	12073	145	12134	310	12272	241	AL12383	276	M2762	152	NE11AP34	265
11760	303	11906	120	11969	292	12074	145	12135	310	12273	233	AL12384	276	M2763	152	NE162932	265
11760	303	11907	120	11970	292	12075	145	12136	310	12274	233	AL12385	276	M3036	175	NE173925	265
11761	353	11908	121	11971	292	12076	145	12137	310	12275	233	AL12386	276	M3037	175	NE17AP25	265
11762	440	11909	121	11972	416	12077	145	12138	310	12276	233	AL12387	276	M3038	175	NE17AP28	265
11763	440	11910	123	11973	400	12078	145	12139	310	12277	235	AL12388	276	M3435	168	NE18AP16	265
11764	441	11911	123	11974	405	12079	146	12140	310	12278	235	AL12389	276	M3950	160	NE18AP21	265
11765	441	11912	383	11975	407	12080	146	12141	310	12279	235	AL12390	276	M3970	168	NE18AP24	265
11766	443	11913	114	11976	407	12081	146	12142	310	12280	235	AL12391	276	M4306	160	NE18AP27	265
11767	443	11914	114	11977	407	12082	146	12143	310	12281	235	AL12392	276	M4307	160	NE18ML15	265
11769	391	11915	92	11978	399	12083	146	12144	310	12282	235	AL12393	276	M4540	168	NE18ML17	265
11770	391	11916	92	11987	211	12084	146	12145	310	12283	235	AL12406	276	M4541	168	NE18ML21	265
11771	391	11917	108	11988	211	12085	146	12146	310	12284	235	ARV11ML20	263	M4542	168	NE18ML23	265
11773	439	11918	108	11991	287	12086	146	12147	310	12285	235	ARV11ML25	263	M4564	163	NE18ML27	265
11774	389	11919	108	11992	287	12087	146	12148	310	12286	235	ARV11ML30	263	M4591	167	NE18ML20	265
11775	389	11920	108	11993	209	12088	146	12149	310	12287	235	ARV162932	263	M4755	160	NE18ML37	265
11776	376	11921	108	11996	316	12089	147	12150	311	12288	231	ARV173925	263	M4756	160	NE36ML16	265
11777	375	11922	108	11998	352	12090	147	12151	311	12289	231	ARV17ML20	263	M4757	160	OL11AP21	269
11778	316	11923	100	12000	195	12091	147	12152	311	12290	231	ARV17ML26	263	M5084	152	OL11AP34	269
11780	312	11923	100	12001	195	12092	147	12153	311	12291	231	ARV18ML17	263	M5202	175	OL162932	269
11781	312	11924	100	12005	208	12093	147	12154	311	12292	231	ARV18ML21	263	M5203	175	OL173924	269
11782	312	11924	100	12006	173	12094	147	12155	311	12293	231	ARV18ML23	263	M5206	175	OL17AP28	269
11787	312	11925	100	12006	173	12095	147	12156	311	12294	231	ARV18ML27	263	M9332	170	OL17ML20	269
11788	312	11925	100	12007	400	12096	147	12157	311	12319	339	ARV368109	263	MA12394	272	OL17ML26	269
11789	312	11926	100	12008	187	12097	147	12158	311	12320	339	ARV36ML16	263	MA12395	272	OL18AP16	269
11790	312	11927	104	12009	187	12098	147	12159	311	12325	389	GL118427	261	MA12396	272	OL18AP21	269
11791	312	11928	166	12010	187	12099	89	12160	311	12326	389	GL118432	261	MA12398	272	OL18AP24	269
11792	312	11929	167	12011	187	12100	89	12161	311	12327	36	GL178325	261	MA12399	272	OL18AP27	269
11794	312	11930	158	12012	187	12101	89	12162	311	12328	36	GL178328	261	MA12400	272	OL18ML15	269
11795	312	11931	159	12013	187	12102	89	12163	311	12329	36	GL18BJ18	261	MA12401	272	OL18ML17	269
11796	312	11932	161	12014	407	12103	89	12164	311	12330	36	GL18BJ21	261	MA12402	272	OL18ML21	269
11797	249	11933	162	12015	213	12104	89	12169	145	12331	36	GL18BJ23	261	MA12403	272	OL18ML23	269
11798	249	11934	163	12016	213	12105	89	12170	146	12332	36	GL18BJ27	261	MA12404	272	OL18ML27	269
11799	249	11935	95	12017	197	12106	89	12171	147	12333	36	GL352708	261	MI11ML25	271	OL18ML30	269
11800	250	11936	95	12018	197	12107	89	12174	302	12334	36	GL36DC14	261	MI11ML30	271	OL36AP14	268
11801	250	11937	95	12019	197	12108	89	12181	212	12335	36	GL36DC17	261	MI11ML34	271	OL36AP16	268
11802	250	11938	95	12020	331	12109	90	12182	354	12336	36	HAL11TT36	274	MI12ML12	271	OL36ML16	268
11803	250	11939	356	12021	331	12110	90	12183	319	12337	36	HAL17TT20	274	MI13ML16	271	OL36ML18	268
11804	250	11941	353	12022	359	12111	90	12184	319	12338	36	HAL18TT27	274	MI162932	271	ON12374	259
11805	250	11942	195	12023	359	12112	90	12185	319	12339	37	HAN17HA23	274	MI173927	271	ON12375	259
11806	250	11943	250	12024	64	12113	90	12186	319	12340	37	HAN17HA26	274	MI17ML20	271	ON12376	259
11807	250	11946	365	12025	64	12114	90	12187	319	12341	37	HAN36HA18	274	MI17ML26	271	ON12377	259
11808	48	11947	365	12026	64	12115	90	12187	319	12342	37	M0010	168	MI18ML15	271	ON12378	259
11808	48	11949	375	12027	64	12116	90	12191	219	12343	37	M1462	163	MI18ML17	271	ON12379	259
11809	372	11950	375	12028	64	12117	90	12192	219	12344	37	M1538	222	MI18ML21	271	ON12380	259
11810	372	11951	312	12029	108	12118	90	12194	397	12345	37	M2161	154	MI18ML23	271	ON12381	259
11811	372	11952	312	12030	100	12119	91	12195	397	12346	37	M2274	152	MI18ML27	271	ON12382	259
11812	372	11953	312	12031	213	12120	91	12196	397	12347	37	M2275	152	MI18ML30	271	ON12405	259
11813	372	11954	312	12032	213	12121	91	12197	397	12348	37	M2283	152	MI31ML08	271	OR11ML30	264
11814	372	11955	312	12033	213	12122	91	12236	238	12349	37	M2297	154	MI32ML21	271	OR11ML34	264
11815	372	11956	391	12034	354	12123	91	12237	238	12350	37	M2397	167	MI36ML18	271	OR17ML26	264
11816	372	11957	186	12038	222	12124	91	12238	238	12365	311	M2710	154	MO118427	260	OR18ML15	264
11817	372	11958	186	12039	224	12125	91	12239	238	12366	311	M2711	154	MO118432	260	OR18ML17	264
11818	364	11959	187	12039	224	12126	91	12240	238	12416	236	M2712	154	MO178325	260	OR18ML21	264
11819	369	11960	187	12047	406	12127	91	12241	238	12417	236	M2713	154	MO178328	260	OR18ML23	264
11820	401	11961	187	12049	213	12128	91	12242	238	12418	236	M2714	154	MO18BJ18	260	OR18ML27	264



Inox AISI 304



Inox AISI 430



Inox AISI 201



Acero de carbono
Carbon Steel



Corcho
Cork



Acrílico
Acrylic



ABS Plastico
ABS Plastic



Policarbonato
Polycarbonate



Polipropileno
Polypropylene



Polipropileno expandido
Expanded polypropylene

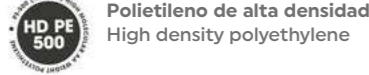

Polietileno de alta densidad
High density polyethylene



Nylon



Silicona
Silicone



Caucho
Rubber



Caucho termoplástico
Thermoplastic Rubber

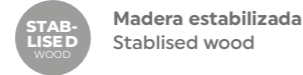

Madera estabilizada
Stabilised wood

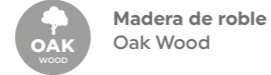

Madera de roble
Oak Wood

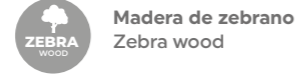

Madera de zebrano
Zebra wood



Madera de palisandro
Rosewood wood

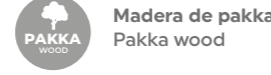

Madera de pakka
Pakka wood



Madera de mikarta
Mikarta wood

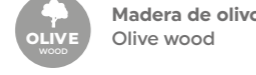

Madera de olivo
Olive wood



Madera de acacia
Acacia wood



Madera de haya
Beech wood

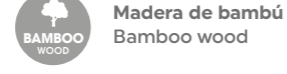

Madera de bambú
Bamboo wood



Triple capa antiadherente
Triple non-stick coating



Fondo sistema sandwich
Sandwich bottom system



Pizarra
Slate



Algodón
Cotton



Kraft



Porcelana
Porcelain



Aluminio
Aluminium



Cobre
Copper

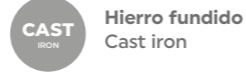

Hierro fundido
Cast iron

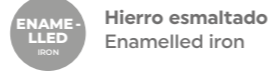

Hierro esmaltado
Enamelled iron



Zinc



Glass
Cristal



Borosilicato
Borosilicate



Fiberglass



Color PVD
PVD color



Diseño propio
Designed in-house



Modular
Modular



Apto para fogón eléctrico
Suitable for Electric Cooker



Apto para horno
Suitable for Oven



Lavar a mano
Hand Wash



No fuego directo
No direct fire



Apto para congelador
Suitable for Freezing



MÁX. 220°C
Temperatura máxima
Max. temperature



Acabado brillo
Mirror finish



No apto para contacto alimentario
Food contact not safe



Recubrimiento antiadherente
Quantanium
Non-stick coating Quantanium



Apilable
Stackable



Sostenible
Sustainable



Apto para gas
Suitable for conventional Gas Cooker



Apto para microondas
Suitable for Microwave



No apto para horno
Not Suitable for Oven



Apto para lavadora
Machine Washable



Hidratar con aceite de oliva
Hydrate with Olive Oil



Apto para contacto alimentario
Food contact Safe



Acabado satin
Satin finish



Recubrimiento non-stick
Non-tick coating



Triple capa antiadherente
Triple non-stick coating



Ligero
Lightweight



Apto para vitrocerámica
Suitable for Vitroceramic



Apto para inducción
Suitable for Induction Cooker



Apto para lavavajillas
Dishwasher safe



No apto para microondas
Not Suitable for Microwave



Soporta hasta 80°C
Until 80°C suport



Combinable con otros productos del catálogo
Combinable with other products in the catalog.



Antideslizante
Anti-slip



Espesor material
Thickness



BBQ
BBQ



Fondo sistema sandwich
Sandwich bottom system

**Si tienes alguna sugerencia o simplemente quieres saludarnos,
¡No dudes en contactarnos!**

For any suggestion or just to greet us, please do not hesitate to contact us!

comaspartners@comaspartners.com

**Y si lo que quieres es estar al corriente de nuestras noticias y novedades, únete a
nuestra comunidad online o suscríbete a nuestro newsletter:**

And if you want to be aware of our news and novelties, join our online
community or subscribe to our newsletter.

newsletter@comaspartners.com



@comasandpartners



@comasandpartners



@comas-and-partners

**El contenido del catálogo está sujeto a modificaciones.
Los datos técnicos y los precios son válidos salvo error tipográfico.**

Texts and images published on this catalogue may contain technical inconsistencies or
typographical errors. The information is subject to periodic changes.

Precios sujetos a las regulaciones aduaneras vigentes en cada momento.

Prices are subject to the applicable customs regulations in effect at all times.

