

**100%Chef**



© 2025 - Cocina sin límites, S.L.

Fotografias / Photos:

Cocina sin límites, S.L.

Francesc Guillamet

Frank Croes - [frankcroes.be](http://frankcroes.be)

Vinyas Photography

AHUMADO Y AROMATIZACIÓN / SMOKING & FLAVOURING .....	05	STONE AGE .....	183
TOOL CONCEPTS .....	37	PORCELAND .....	219
ESFERIFICACIONES Y GELATINAS / SPHERIFICATIONS & GELATINES .....	119	CERAMICS ERA .....	249
SOUS VIDE .....	133	GLASS CONCEPTS .....	265
NITRO .....	157	HYPERREALISM .....	351
PRECISION .....	171	TABLE TOP .....	365
		CATERING .....	407
		BBQ .....	473
		INOX .....	485
		MOLDES Y MARCADORES / MOULDS & MARKERS .....	509

*"El ahumado es una de las técnicas de conservación de alimentos más antiguas. Además de prolongar la vida útil del producto, esta práctica mejora su sabor, ya que los aceites esenciales y resinas del humo impregnan el alimento, otorgándole un aroma y gusto distintivos"*

*"Smoking is one of the oldest food preservation techniques. In addition to extending the shelf life of the product, this method enhances its flavor, as the essential oils and resins in the smoke infuse the food, giving it a distinctive aroma and taste"*



# AHUMADO Y AROMATIZACIÓN SMOKING & FLAVOURING

ALADIN 007 FLAVOUR .....	07
Aromatización y nieblas para alimentación y coctelería Flavouring and mist for food and cocktails	
SUPER ALADIN .....	15
Ahumador y aromatizador gastronómico profesional Professional gastronomic smoker and flavourer	
GENIUS BUBBLE KIT .....	17
Aromatización y ahumado en forma de pompa Flavouring and smoking in a bubble shape	
ALADIN 007 .....	18
Ahumado aromatizado especializado para la coctelería Specialised flavoured smoke for cocktails	
CAMPANAS Y OTROS / CLOCHES & OTHERS .....	23
Productos y complementos para el ahumado y aromatizado Smoking & flavouring products and accessories	

# Aladin Flavour<sup>®</sup> 07 Pro

La evolución de la aromatización  
The evolution of aromatization

Descubre la versión mejorada de 007 Aladin Flavour<sup>®</sup>.

Un modelo rediseñado que te permite crear **pompas** y **nubes** de humo de manera **más versátil** y **potente**, obteniendo como resultado pompas gigantes en apenas segundos o diferentes efectos de humo y aroma en copas y platos.

Discover the improved version of 007 Aladin Flavour<sup>®</sup>. A redesigned model that allows you to create **bubbles** and **clouds** of smoke in a more versatile and powerful way, resulting in giant bubbles in seconds or different smoke and flavour effects in glasses and plates.

## 007 Aladin Flavour Pro

10/0082	Blue
10/0091	Black
10/0092	Gold



Conoce todo sobre Aladin Flavour  
Learn all about Aladin Flavour



El kit contiene / Kit contains

Aladin 007 Flavour Pro

4 aromatizadores Aladin 007 Flavour Pro

4 Aladin 007 Flavour Pro aromatizers

Aladin Mixture Bubbler XR 100 ml

2 baterías 9 V recargables y cable de carga

2 rechargeable 9V batteries & charging cable

Manual de instrucciones

Instruction manual





**Aladin**  
**Flavour**  
**Pro**

Misma forma, más posibilidades  
Same shape, more possibilities

Su diseño optimizado permite un **manejo más sencillo y rápido**, lo que facilita cambiar los aromatizadores en tan solo segundos, facilitando la personalización de cada presentación. Además, con la nueva solución concentrada **Bubbler XR**, apta para alimentación, podrá generar pompas rellenas de vapor aromático súper estables.

Its optimized design makes **management easier and faster**, allowing you to change the aromatizers in just seconds and customise each presentation. In addition, the new food-safe **Bubbler XR** concentrated solution enables you to produce highly stable bubbles filled with aromatic vapour.



10/0089  
Mixture Bubbler XR 200 ml

La revolución en pompas gastronómicas  
The revolution in gastronomic bubbles

Presentamos Bubbler XR, la evolución de nuestro clásico Bubbler, una solución alimentaria **ultrarresistente** pensada para destacar en hostelería y coctelería. Su **fórmula renovada**, tres veces **menos jabonosa**, proporciona una **mayor elasticidad y resistencia**, permitiendo crear pompas estables y perfectas con un menor margen de error y menos residuo de jabón y sabor en platos o cócteles.

Introducing Bubbler XR, the evolution of our classic Bubbler: an **ultra-resistant** food solution designed to stand out in the hospitality and cocktail industry. Its **renewed formula**, three times **less soapy**, provides **greater elasticity and resistance**, allowing you to create stable and perfect bubbles with lower margin for error and less soap and flavour residue on dishes or cocktails.

# Aladin Flavour Tools

Nuevos adaptadores para nuevas experiencias  
New adapters for new experiences

Este kit contiene tres adaptadores que permiten tratar la niebla de los aromatizadores de maneras diferentes.

Poniendo el aromatizador en posición horizontal podrás conseguir nieblas y perlas irrompibles de vapor frío extremadamente denso y aromático gracias a su nuevo sistema de condensación en frío por presión.

Por otro lado, en vertical, conseguirás cruzar aromas simultáneamente o intensificar su sabor.

This kit contains three adapters that allow to treat the vapour from the aromatizers in different ways.

By placing the aromatizer in horizontal position you will get unbreakable pearls and extremely dense and aromatic cold mists, thanks to its new pressurized cold condensation system. On the other hand, in vertical, you will be able to blend aromas simultaneously or intensify their flavour.



## 007 Aladin Flavour Tools

10/0103	Blue
10/0104	Black
10/0105	Gold

Combinación de aromas  
Aroma combination



Double head

Niebla fría y densa  
Cold & dense mist



Fogg Nozzle

Dirección y control  
Direction & control



Slim



Para combinar o potenciar los sabores de los aromatizadores, utilice Double Head. Alternativamente, combine Fog Nozzle y Slim para trabajar con el aromatizador en horizontal y así conseguir nieblas frías más densas, pesadas y ultra aromáticas.

To combine or enhance flavors of aromatizers, use Double Head. Alternatively, combine Fog Nozzle and Slim to work with the aromatiser horizontally for denser, heavier, ultra aromatic cold mists.

*007 Aladin Flavour Tools es compatible con el modelo anterior de 007 Aladin Flavour, Super Aladin y 007 Aladin, sin necesidad de adaptadores extras.*

*007 Aladin Flavour Tools is compatible with the previous model of 007 Aladin Flavour, Super Aladin and 007 Aladin, without the need for extra adapters.*



Haz de tus presentaciones un espectáculo  
Make your presentations a show

YouCook

## 007 Flavour aromatizers

Cargas de vapor aromatizado sin nicotina  
Nicotine-free flavoured mist loads

+120 aplicaciones  
applications

10/0076	Piña / Pineapple
10/0077	Arándanos / Blueberries
10/0078	Menta / Mint
10/0079	Manzana verde / Green apple
10/0080	Plátano / Banana
10/0081	Citronela / Lemongrass
10/0093	Neutro / Neutral
10/0095	Chocolate Coffee
10/0096	Canela / Cinnamon
10/0097	Lavanda / Lavander
10/0099	Puro Habano Cigar



Guía de uso de aromatizadores  
Guide to the use of aromatizers

YouCook



## ¡ATENCIÓN! / ATTENTION!

Nuestros aromatizadores y recargas 007 Flavour contienen exclusivamente aromas alimentarios, con la finalidad de aromatizar los alimentos y bebidas con total seguridad. No son aceites esenciales, ni líquidos aromatizados para vapors, erróneamente utilizados muchas veces por desconocimiento.

Our 007 Flavour aromas and refills contain exclusively food flavourings, with the purpose of flavouring food and beverages with total security. They are not essential oils, nor flavored liquids for vapors, often mistakenly used out of knowledge.



10/0098

Aromatizador rellenable  
Refillable aromatizer

10 uds  
pcs

Rellene su aromatizador con 3 ml de  
esencias especiales del aroma escogido

Fill your aromatizer with 5 ml of special  
essences from the chosen aroma



Técnica y consejos para el relleno  
Technique and tips for filling

YouCook

## 007 Aromatic Flavour

Recargas para aromatizador rellenable  
Recharges for refillable flavourizer

10 ml

10/0107	Almendra amarga / Almond		10/0113	Frutas tropicales / Tropical		10/0120	Regaliz / Liquorice	
10/0108	Cacaheute / Peanut		10/0114	Ginebra / Gin		10/0121	Rosas / Roses	
10/0109	Café / Coffee		10/0115	Humo / Smoke		10/0122	Trufa / Truffle	
10/0110	Azúcar caramelo / Toffee		10/0116	Lima-limón / Lime-lemon		10/0123	Vainilla Bourbon	
10/0111	Chocolate		10/0117	Melocotón / Peach		10/0124	Whisky	
10/0112	Fresa / Strawberry Bubble		10/0118	Melón / Melon		10/0125	Yogurt / Yoghurt	
			10/0119	Piña colada				



Cada botella permite cargar hasta 3 veces el aromatizador rellenable

Each bottle can refill up to 3 times the refillable aromatizer

Nuestras esencias han sido clasificadas en *Hot & Cold* para respetar su aroma y conseguir diferentes notas aromáticas según si se coloca el aromatizador en posición vertical (**Hot**, pasando por el atomizador) u horizontal (**Cold**, con *Fog nozzle* de *Tool Kits*). A su misma vez permiten jugar con diferentes matices de un mismo aroma (**Hot & Cold**).

Our essences have been classified as *Hot & Cold* to respect its aromas or, in other cases, to obtain different aromatic notes depending on whether the aromatizer is placed vertically (**Hot**, passing through the atomizer) or horizontally (**Cold**, with the *Fog nozzle* of *Tool Kits*). They also allow you to play with different shades of the same aroma (**Hot & Cold**).

# Super Aladin®

Ahumador aromatizador profesional  
Professional flavouring smoker

Super Aladin® es el único ahumador manual totalmente metálico, resistente al empleo diario o semi-industrial. La doble cámara permite combinar el ahumado con aromas y aceites esenciales consiguiendo humos fríos, limpios y muy aromáticos.

Super Aladin® es el primer ahumador de mano fabricado en el mundo. El inicio de una técnica que, a pesar de sus más de 20 años sigue estando presente en la vanguardia de la gastronomía mundial.

Super Aladin® is the only manual all-metal smoker, resistant to daily or semi-industrial use.

The double chamber allows to combine smoking with aromas and essential oils to obtain cold, clean and very aromatic smoke. Super Aladin® is the first hand smoker manufactured in the world. The beginning of a technique that, despite more than 20 years, is still at the forefront of world gastronomy.



10/0003  
Super Aladin



— [Icon] —  
Instrucciones en el interior  
User manual inside

Hélice de aluminio desmontable  
Aluminium removable fan

Fácil limpieza, reparación  
y mantenimiento  
Easy cleaning, repair,  
and maintenance

Interruptor frontal  
New easy switch



Super Aladin® y su funcionamiento  
Super Aladin® and how it works





Técnicas de ahumado en frío  
Perfect cold smoking technique



Cámara para chips  
Chips chamber

Cámara para aromatización  
Aromatization chamber



# Genius Bubble - Kit

Ahumador aromatizador instantáneo de burbujas  
Instant Bubble smoker and aromatizer

Genius Bubble Kit® genera de forma instantánea pompas transparentes sobre bebidas y recipientes con o sin humo. Aromatiza el humo con distintas maderas, aceites esenciales o tabacos saborizados para shisha. Además, puede funcionar como ahumador instantáneo para campanas o recipientes cerrados.

The Genius Bubble Kit® can instantly generate transparent bubbles in drinks and containers, with or without smoke. The smoke can be flavoured with various woods, essential oils or flavoured shisha tobaccos. It can also be used as an instant smoker in closed cloches or containers.



Descubre cómo funciona  
Discover how it works

YouCook



10/1000  
Genius Bubble-Kit

El kit incluye serrín,  
Mixture Bubbler XR y  
conexión para campana  
The kit includes sawdust,  
Mixture Bubbler XR and  
a cloche connection

10/0089 200 ml  
Mixture Bubbler XR

Burbujas de gel alimentario  
Food grade gel bubbles



# Aladin 007



Ahumador aromatizador  
Flavourer smoker

Aladin 007® es el ahumador profesional preferido por los bartenders de todo el mundo, su potencia y producción de humo frío permite no enmascarar los aromas de la madera o incorporar aromas mediante esencias o elementos frescos como la piel de limón o raíces como la regaliz. Con Aladin 007®, la técnica del ahumado frío sin combustión permite la incorporación de aromas añadidos y aceites esenciales, generando nuevas y creativas aplicaciones del ahumado en sus bebidas.

Aladin 007® is the preferred professional smoker among professional bartenders around the world. Its power and cold smoke production allows not masking wood aromas or the incorporation of aromas through essences or fresh elements such as lemon peel or roots such as licorice. With Aladin 007®, the non-combustion cold smoking technique allows the incorporation of added aromas and essential oils, enabling you to create new and exciting ways to smoke your drinks.

Disco Aladin CD incluido en el kit  
Aladin CD included with the kit



Detalles y consejos  
Details and tips



10/1009  
Aladin 007 / Black edition

10/0009  
Aladin 007

Nueva hélice  
plug & play  
New plug & play  
helix



# Aladin Chips

Serrín para ahumado  
Smoking sawdust

80 gr

10/0004	Haya / Beech Wood
10/0027	Roble / Oak Wood
10/0042	Jack Daniel's Original Tennessee Whiskey
10/0052	Olivo / Olive Wood
10/0054	Almendra / Almond Wood

El serrín o chips es una parte fundamental para conseguir un buen ahumado. Utilizar maderas con origen y, saber cómo prepararlas antes del ahumado es uno de los secretos mejor guardados. Descubre en nuestros videos las técnicas que harán de tu ahumado algo único y diferente.

Sawdust and wood chips are fundamental for good smoking. Using wood of a certain origin and knowing how to prepare it beforehand is one of the best-kept secrets. Watch our videos to discover the techniques that will make your smoking experience unique.



Maderas y su aromatización  
Woods and their flavouring

100%Lab



10/0028

Virutas ahumadas de barril Jack Daniel's  
Jack Daniel's barrel smoking chips

800 gr

Utiliza las virutas previamente humedecidas en barbacoas, asadores o ahumadores y conseguirás ahumados o carnes asadas con un aroma increíble, o bien pruébalas en infusiones en agua, leche... Tal cual fuera una rama de canela.

Use the chips after moistening them in a barbecue, rotisserie or smoker to give your meats an incredible smoked or roasted aroma. Or try using them in infusions with water or milk... Just like a cinnamon stick.



# Aladin®

Recambios para Super Aladin, 007 y Flavour  
Accessories and complements for  
Super Aladin, 007 and Flavour



Transforme su ahumador Super Aladin o 007 en un potente vaporizador con aromas y genere pompas rellenas de aromas o rellene campanas u otros recipientes con vapor aromático.  
Este kit contiene cableado y un portapilas para baterías de 9V, que elevan la potencia de la máquina.

Transform your Super Aladin or 007 smoker into a powerful aroma vaporizer, capable of creating aroma-filled bubbles or filling cloches and other containers with aromatic vapour.  
This kit includes wiring and a battery holder for 9V batteries to increase the power of the machine.



Guía de conversión  
Conversion guide



10/0083  
Conversion Kit

# Magic Gloves



10/0106  
Magic gloves

¡Una nueva forma de interactuar con las burbujas!  
Crea efectos visuales sorprendentes sin que se rompan gracias a su tejido especial que elimina la electricidad estática.

A new way to interact with bubbles!  
Create amazing visual effects without breaking them thanks to its special fabric that eliminates static electricity.





## TAPA INOX PARA AHUMADO EN CUBETA STAINLESS STEEL LID FOR SMOKING

10/0033

Tapa inox GN 1/1 con válvula  
Stainless steel GN lid 1/1 with valve

Utilice nuestra tapa GN de ahumado en frío para ahumar, mantequillas, carnes o pescado de forma sencilla y controlada.

Utilice cualquier recipiente GN 1/1 y nuestra tapa Aladin.

Use our GN lid for smoking, butters, meats or fish in a simple and easily and in a controlled way. Use any 1/1 GN container and our Aladin lid.



## ALADIN STATION

Ahora puede trabajar con su Super Aladin® totalmente en horizontal, evitando la entrada de resina en el motor. ¡Humedezca el serrín tanto como quiera!

Work with your Super Aladin® in a flat position, preventing resin from entering the engine.

An easy way to control the humidity of the sawdust!

10/0031  
Aladin Station



Vídeo completo técnicas de ahumado  
Full video of smoking techniques

YouCook



10/0005  
Aladin filtros XS  
Aladin screens XS

5 uds  
pcs

10/0006  
Aladin filtros XL  
Aladin screens XL

5 uds  
pcs



10/0010  
Super Aladin Rotor



10/0030  
Super Aladin & 007  
Conexiones eléctricas interruptor en la base  
Electrical spare parts - bottom switch



10/0048  
Super Aladin & 007  
Conexiones eléctricas interruptor frontal  
Electrical spare parts - frontal switch



10/0100  
007 flavour  
Conexiones eléctricas  
Electrical spare parts



Motor con hélice  
Engine with fan

10/0012  
Heavy wheel Kit

10/0032  
Motor / Engine

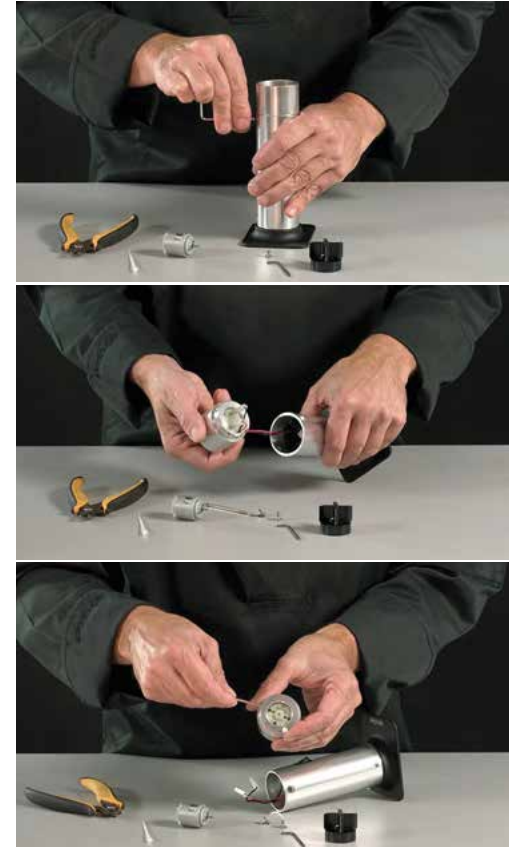

Tutorial de cuidados y mantenimiento  
Maintenance and care video guide

**YouCook**



## CAMPANAS A LA CARTA CLOCHES ON DEMAND

Campanas extremadamente resistentes que transformarán bebidas o emplatados en experiencias únicas.

Podrá escoger entre nuestra colección o, pedir bajo encargo un diseño personalizado que se adapte a sus gustos y necesidades.

Extremely resistant cloches that will transform drinks or plating into unique experiences.

You can choose from our collection or order a custom design to suit your tastes and needs.



Fabricadas en borosilicato,  
extremadamente resistente al  
choque térmico.

Made with borosilicate  
glass, extremely resistant  
to thermal shock.

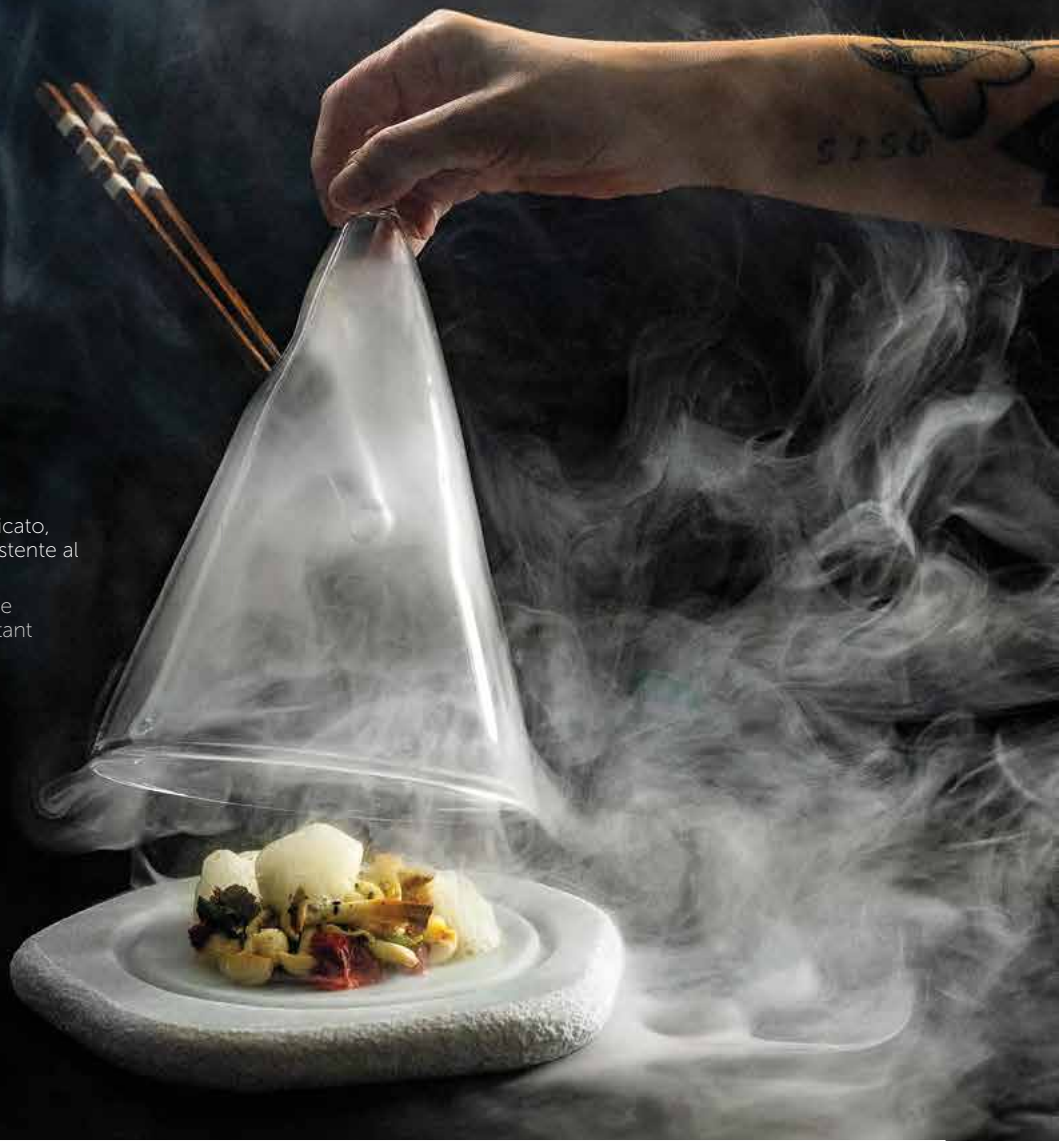



#### CAMPANAS PERSONALIZABLES

Escoja su forma y tamaño, nosotros fabricaremos sus campanas a medida, con un pedido mínimo de 12 unidades. Consulte las opciones.

#### CUSTOMIZABLE CLOCHES

Choose your shape and size, we will manufacture your custom design, with a minimum order of 12 units. Consult options.





10/0024  
Campana globo  
Balloon cloche

\*plato no incluido\*



Con válvula / With valve  
Ø 18 cm - Alt / Height: 19 cm

10/0084  
Campana Ambar  
Ambar cloche

### CAMPANA AMBAR "15 ANIVERSARIO" AMBAR CLOCHE "15TH ANNIVERSARY"

Celebra con nosotros los 15 años del lanzamiento de nuestra primera campana con válvula Aladin, un modelo que ha sabido mantener su estilo, además de ser imitada por otros fabricantes.

Con motivo de este aniversario, presentamos una nueva versión fabricada con vidrio de borosilicato ámbar transparente.

Celebrate with us 15 years since the launch of our first Aladin valved cloche, a model that has maintained its style and has been imitated by other manufacturers.

On this anniversary we present a new version made of amber borosilicate clear glass.

# Aladin Cover®

## Campanas para ahumado

Aladin Cover® fue la pionera, el primer modelo de campanas con válvula que permite la inyección de humo y aromas en los platos o recipientes para el servicio, sin tener que levantarlas.

## Smoking glass cloches

Aladin Cover® was the pioneer of the first model of cloches with a valve that allow the injection of smoke and aromas into dishes or containers for service, without having to lift them.



## Campana Aladin con válvula Aladin cloche with valve

10/0043 Ø 14 cm

10/0044 Ø 18 cm



1 pack



## Campana Aladin con válvula Aladin cloche with valve

10/0022 Ø 9 cm

10/0013 Ø 14 cm

10/0015 Ø 18 cm



6 uds  
6 pcs



## Campana Aladin sin válvula Aladin cloche without valve

10/0023 Ø 9 cm

10/0014 Ø 14 cm

10/0016 Ø 18 cm



6 uds  
6 pcs

**10/0019**  
Válvulas de silicona  
de recambio  
Replacement silicone valves

**6** uds  
6 pcs

## CAMPANA PARA AHUMADO TAJINE TAJINE SMOKING CLOCHE

10/0017

Campana Tajine con válvula  
Tajine plate cover with valve

10/0018

Campana Tajine sin válvula  
Tajine plate cover without valve



Ø 18 cm

6 uds  
pcs



## ALADIN CD

Conecta cualquier modelo de Aladin con todo tipo de envases, vasos, cocteleras, sifones, tarros de conserva, etc.

Connect any model of Aladin Smoking Gun to any container, glass, cocktail shaker, siphon, jar, etc.

10/0029

Aladin CD

Ø 12 cm



160/0042  
Jarra Humo Frio  
Cold Smoke Pitcher



25 cm

Ø 11 cm



10/0046  
Campana Jarra XS  
Pitcher Shaped Cover XS



21 cm

Ø 14 cm



10/0047  
Campana Jarra XL  
Pitcher Shaped Cover XL

XL Compatible con base  
iluminada 10/0085  
XL Compatible with illuminated  
base 10/0085



24 cm

Ø 18 cm

# BUFFET

Buffets de quesos, pescados ahumados, barbacoas...

Buffet of cheese, smoked fish, barbecue to share...

Con válvula / With valve  
 Ø 25 cm - Alt / Height: 21 cm

10/0039  
 Campana Buffet  
 Buffet Cover



Elegantes e icónicas, estas nuevas campanas permiten presentar platos con humo, vapores aromáticos y hielo seco, convirtiéndose en unas auténticas herramientas gastronómicas.

Sleek and culinary, these new cloches allow dishes to be presented with smoke, aromatic vapours and dry ice, transforming them into authentic culinary tools.



## Gastronaut

10/0063 Campana con válvula / DOME with valve

10/0066 Campana sin válvula / DOME W/O valve

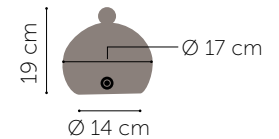

## CAMPANAS MIXOLOGIST

Ahora podrá ahumar todas sus copas de cóctel con nuestras campanas Mixologist con válvula. Transformarán una presentación convencional en un regalo precioso para sus clientes.

## MIXOLOGIST CLOCHES

Designed to fit any kind of cocktail glass, the Mixology Cloches are the detail that can transform a lousy drink presentation into a precious gift for your customer's eyes.



**A** 10/0035  
Campana Cocktail  
Cocktail Cover

**B** 10/0034  
Campana Long Drink  
Long Drink Cover



## MATRIX·OSKA

Matrioska clásica pintada a mano, con válvula integrada para ahumar. Sorprenda a su cliente al abrir la muñeca.

Hand-painted classic Matryoshka doll with integrated smoking valve.

Surprise your customer when opening the doll.

Conoce la historia y evolución sobre el ahumado  
Learn about the evolution and history on smoke



10/0060  
Matrix-Oska

Ø 10 cm - Altura / Height: 23 cm  
Interior / Internal: Ø 7,8 cm



## VOLCANO

Con un ingenioso cráter en el centro, este vaso de borosilicato permite preparar cócteles ahumados y saborizados con humo o hielo seco, y dar un toque singular a sus servicios.

La base de mármol negro con capacidad de 150 ml aporta a la bebida un toque de elegancia y sofisticación.

With an ingenious crater in the center, this borosilicate glass allows you to prepare smoked and flavored cocktails with smoke or dry ice, and give a unique touch to your services.

The black marble base with a 150 ml capacity gives the drink a touch of elegance and sophistication.

160/5095

Volcano

Ø 18 cm

Alt / Height: 19 cm



Descubre nuestros *Glass Concepts*  
Discover our *Glass Concepts*

**100%Chef**



Con serrín para ahumado  
With smoking Wood Chips



Con hielo seco  
With dry ice

## AHUMADOR DE VASOS GLASS SMOKER

10/0061

Ahumador para vasos  
Glass Smoker

Ext.: Ø 9,5 cm / Int.: Ø 8,5 cm  
Alt / Height: 7 cm



Base de mármol



\*vaso no incluido\*



\*glass not included\*



## Campanas iluminadas Light covers

Campanas iluminadas con bases de luz LED, perfectas para crear una **experiencia visual** única gracias a las decenas de colores personalizados, diferentes intensidades y efectos temporizados. Son la solución segura para colorear el humo o vapor sin comprometer la salud. Además, el disco de luz es totalmente impermeable y podrá sumergirlo en una cubitera y lograr que el hielo adquiera tonalidades vibrantes y envolventes. ¡Transforme sus bebidas y emplatados en auténticas obras de arte!

Illuminated bells with LED light bases, perfect for creating a **unique visual experience** thanks to dozens of customised colours, different intensities and timed effects. They are the safe solution for colouring smoke or vapour without compromising health. What's more, the light disc is completely waterproof and you can dip it into an ice bucket and make your ice take on vibrant, enveloping hues. Transform your drinks and plating into true works of art!



## LightYear Kit

10/0064 Kit Campana con válvula / DOME with valve Kit

10/0065 Kit Campana sin válvula / DOME W/O valve Kit



El kit se compone de campana, tapa de silicona, disco luz led, mando a distancia. Pilas no incluidas.  
The kit includes a cloche, silicone lid, LED light disc, and remote control. Batteries are not included.



## LightYear Cloche

10/0074 Repuesto campana con válvula  
Replacement cloche with valve

10/0075 Repuesto campana sin válvula  
Replacement cloche W/O valve

10/0070  
Silicona repuesto  
Spare silicone

Ø 13 cm  
Alt / Height: 4 cm



10/0071  
Luz LED repuesto  
Spare LED light

Ø 9 cm  
Alt / Height: 3,5 cm



## LONG DRINK TUBE

Versátil campana tubular de doble posición con válvula para inyección de humo o vapor aromático. Con dos bases de iluminación independientes, permite combinar diferentes colores para crear un efecto de degradado.

Versatile double-position tubular cloche with valve for injection of smoke or aromatic vapor. With two independent lighting bases, it allows combining different colors to create a gradient effect.



10/0087

Kit Long Drink Tube

El kit incluye / Kit includes

- Campana tubular
- Base de madera
- Tapa de metacrilato
- 2 discos LED
- 2 mandos a distancia
- Soporte superior de silicona
- Tubular cloche
- Wooden base
- Acrylic cover
- 2 LED lights
- 2 remote conreolers
- Silicone stand

10/0069

Long Drink tubo repuesto  
Long Drink spare tube

10/0086

Base Long Drink con luz RGB  
Long Drink base with RGB light

Ø 16 cm - Alt / Height: 5 cm





## COCKTAIL BASE

Esta base de madera natural con luz LED está diseñada especialmente para nuestras campanas Cocktail. Dé un toque de iluminación sofisticada a sus cócteles y bebidas mientras permanecen delicadamente cubiertos por la campana. Incluye una base de madera de cerezo, una tapa de metacrilato y un disco de luz RGB con mando a distancia, proporcionando un control total sobre la ambientación.

This wooden base with LED light is specially designed for our Cocktail cloches. Add a touch of sophisticated lighting to your cocktails and drinks while keeping them delicately covered by the cloche. It includes a cherry wood base, an acrylic lid and an RGB light disc with a remote control, giving you complete control over the ambience.

10/0101  
Cocktail Kit Base

El kit incluye: Campana Cocktail, Base Cocktail, tapa de metacrilato, disco de luz LED RGB y mando a distancia  
The kit includes: Cocktail cloche, Cocktail base, acrylic lid, RGB LED light disc, and remote control



10/0085  
Cocktail Base

Ø 21 cm - Alt / Height: 5 cm



10/0085 + 10/0047  
Base Cocktail + Campana Jarra XL  
Cocktail Base + Pitcher shaped cover XL





10/0102  
Kit Base Long Drink

- Kit completo / Complete Kit
- Campana Long Drink
- Base Cocktail
- Tapa de metacrilato
- Disco LED
- Mando a distancia
- Cocktail Cloche
- Cocktail base
- Acrylic lid
- Led light
- Remote control

10/0086  
Base Long Drink con luz RGB  
Long Drink base with RGB light

Ø 16 cm - Alt / Height: 5 cm  
Base de madera lacada  
negra para campanas  
Black lacquered  
wooden base for  
Long Drink cloches



*"Esenciales para la cocina de vanguardia"*

*"Essentials for avant-garde cuisine"*



# TOOL CONCEPTS

SISTEMAS / SYSTEMS .....	39
Maquinaria técnica versátil Versatile technical machinery	
TOOLS & MORE .....	65
Herramientas y máquinas especializadas Specialized tools and machinery	
AIREANTES / AERATING AGENTS.....	87
Texturas aéreas y ligeras Airy and light textures	
DESHIDRATADORAS Y LIOFILIZADO DEHYDRATORS & FREEZE-DRYING .....	91
Deshidratación y reducción de humedad Dehydration and moisture reduction	
HELADORAS / FREEZERS .....	103
Recetas y preparaciones en frío Recipes and cold preparations	
SWEET .....	107
Desde bean to bar a otros procesos para elaboraciones dulces From bean to bar to other methods for sweet elaborations	
TROLLEYS .....	117
Exclusiva línea de carros de servicio Exclusive service cart line	

# Heinzelmann CHEF-X

Thermo blender profesional multifuncional  
Professional multifunctional thermo blender

CHEF-X ha sido creada para un **uso intensivo** en entornos de **cocina exigentes**. Con ingeniería alemana y desarrollada junto a chefs, ofrece **resistencia**, **eficiencia** y **versatilidad** para preparar y cocinar con rapidez y precisión, sin perder calidad ni sabor.

Su potencia permite ejecutar múltiples técnicas como batir, cocer, emulsionar, moler, triturar, entre otras, en un diseño robusto con carcasa reforzada y componentes de alta durabilidad.

Designed for intensive use in demanding kitchen environments, CHEF-X is the ultimate tool for professional chefs. Developed in collaboration with chefs and featuring German engineering, it offers **resistance**, **efficiency** and **versatility** for fast and precise preparation and cooking without compromising on quality or flavour.

Its powerful performance enables you to perform a variety of techniques, including beating, cooking, emulsifying, grinding and crushing, all within a robust design featuring reinforced housing and highly durable components.

30/8000

Heinzelmann Chef-X set

1400 W, 220 / 240 V, 50/60 Hz  
42 x 26 cm Altura / Height 33 cm



¿Qué la hace tan especial?  
What makes it so special?



### CAPACIDAD CAPACITY

Su jarra cónica, de posicionamiento libre, dispone de una capacidad de 2,2 L de volumen, pero cuenta con una capacidad de recipiente de 2,9 L, perfecto para todo tipo de preparaciones básicas.

Its conical jar, which can be positioned anywhere, has a capacity of 2,2 L, but the container has a capacity of 2,9 L, perfect for all kinds of basic preparations.



### PANEL DE CONTROL MANUAL MANUAL CONTROL PANEL

Permite ajustar con precisión temperatura, tiempo y potencia de manera intuitiva, optimizando los tiempos de cada preparación.

It enables you to intuitively adjust the temperature, time and power with precision, optimising the preparation time for each dish.



### MULTIPULSO MULTIPULSE

Permite variar la potencia en intervalos, haciendo que la velocidad sea variable, consiguiendo así diferentes resultados de mezcla.

It allows you to vary the power in intervals, making the speed variable and thus achieving different mixing results.



### VELOCIDAD Y PRECISIÓN SPEED AND PRECISION

Su potente motor impulsa en dos direcciones unas cuchillas de 4 ángulos, hasta una velocidad máxima de 10500 rpm, para ofrecer acabados extra suaves o mezclas totalmente homogéneas.

Its powerful motor drives 4-angle blades in two directions, up to a maximum speed of 10,500 rpm, to deliver extra-smooth finishes or completely homogeneous mixtures.



### TAPA CON LUZ LIGHTED LID

Permite ver rápidamente lo que ocurre en el interior del recipiente durante el funcionamiento.

Allows you to quickly see what is happening inside the container during operation.



### CERTIFICACIONES INTERNACIONALES INTERNATIONAL CERTIFICATIONS

Todos los componentes están fabricados con materiales de alta calidad para garantizar un uso continuo y prolongado, con los mejores resultados.

All components are manufactured from high-quality materials to ensure continuous and prolonged use, with the best results.



Control manual para trabajar con mayor facilidad y eficiencia  
Manual control for easier and more efficient operation

### 1. Control de temperatura / Temperature control

Potencia de calentamiento de 1050 W con un rango de temperatura entre 37°C y 130°C.

Heating power of 1050 W with a temperature range between 37°C and 130°C.

### 2. Reverse / Turbo / Multi-pulse

**Reverse:** mezclado en sentido contrario con el lado romo de la cuchilla.

**Turbo:** velocidad máxima de 10.500 rpm para obtener resultados extra suaves.

**Multi-pulse:** 7 configuraciones individuales de pulsos, con alteraciones de velocidad para resultados personalizados.

**Reverse:** reverse blending with the blunt side of the blade.  
**Turbo:** maximum speed of 10,500 rpm for extra smooth results.

**Multi-pulse:** 7 individual pulse settings, with speed variations for customized results.

### 3. Temporizador / Timer

Control de tiempo y cocción según se desee.

Time and cooking control as desired.

### 4. Velocidad / Speed

10 niveles de velocidad que pasan de agitación suave, mezclado de alta velocidad o picado.

10 speed settings ranging from gentle stirring to high-speed mixing or chopping.

### 5. Pausa / Pause

Comprueba el estado de tu preparación sin perder los ajustes establecidos.

Check the status of your preparation without losing your settings.

Versátil y multifuncional  
Versatile and multifunctional

¡Ahúma tus preparaciones fácilmente!  
Tapa con válvula compatible con *Super Aladin*.

Smoke your dishes with ease!  
Lid with valve compatible with our *Super Aladin*.



Licúa, mezcla, pica y homogeneiza los productos más complicados sin comprometer la maquinaria.

Blend, mix, chop, and homogenize the most complicated products without compromising your equipment.



Amasa, monta, bate y emulsiona para prepara salsas, mousses, mayonesas entre muchos más!

Knead, whip, beat, and emulsify to prepare sauces, mousses, mayonnaise, and much more!



Cuece, carameliza e infusiona.  
¡Da rienda suelta a tu imaginación!

Cook, caramelize, and infuse.  
Let your imagination run wild!



## Accesorios / Accessories



Opción de tapón con válvula para poder ahumar los productos en su interior  
Option of stopper with valve to smoke the products inside

Tapa con función de bloqueo para evitar que la maquina funcione sin estar cerrada  
Lid with locking function to prevent the machine from operating when not closed

Sistema de seguridad para evitar sobrecargas y sobrecalentamiento  
Safety system to prevent overloads and overheating

Accesorios aptos para lavavajillas.  
¡Agiliza cada preparación!  
Dishwasher-safe accessories that make every preparation easier and faster





### 30/8001

Luz LED  
LED light

Iluminación precisa formada por 2 leds de 60 mA y con apagado automático a los 20 segundos.

Precise lighting consisting of two 60 mA LEDs with automatic shut-off after 20 seconds.



### 30/8004

Cuchilla con junta  
Blade with seal

Fabricada en acero inoxidable 420 y un revestimiento de titáneo de 4 ángulos y 2 niveles.

Made of 420 stainless steel with a 4-angle, 2-level tint coating.



### 30/8007

Espátula  
Spatula

Se adapta perfectamente al bol para poder llegar a todos los rincones.

It fits perfectly into the bowl so you can reach every corner.



### 30/8002

Tapón transparente  
Transparent lid cap

### 30/8068

Tapón con válvula de ahumado  
Lid cap with smoking valve



### 30/8005

Tapa con junta  
Lid with seal

Tapa con dos asas orientadas hacia arriba para facilitar su manejo.

Lid with two upward-facing handles for easy handling.



### 30/8008

Bol  
Bowl

Bol de repuesto o extra para aumentar la productividad.  
Spare part or extra bowl to increase productivity.



### 30/8003

Batidor  
Whisk

Mezcla, bate, monta y emulsiona.

Mix, whisk, whip, and emulsify.



### 30/8006

Cesta para cocción a fuego lento  
Simmering basket

Hierve o cuece al vapor los ingredientes evitando que toquen las cuchillas.

Boil or steam the ingredients, making sure they do not touch the blades.



# QBO5 by roboqbo THE PROCESS

Sistema todo en uno para una infinidad de recetas

La QBO5 es mucho más que una máquina; es un sistema automatizado integral de cocción, abatimiento, vacío, presión, corte, emulsión y otras funciones, todo en un único equipo compacto.

La empresa italiana Roboqbo ha diseñado este excepcional equipo de 5 litros para todo tipo de profesionales del sector alimentario. Esta solución «todo en uno» optimiza los procesos y garantiza resultados de alta calidad sin afectar a las propiedades de los ingredientes. Aumenta la rentabilidad de los negocios, ya que permite amortizar el equipo en pocos meses.

QBO5  
roboqbo

30/6001  
trifásica / 3-phase

All-in-one system for infinite recipes

The QBO5 is much more than just a machine; it is a complete automated system for cooking, blast chilling, vacuum, pressure, cutting, emulsifying and other functions, all in one compact unit.

The Italian company Roboqbo has designed this unique 5 litre machine for all types of cuisine professionals. This all-in-one solution optimises processes and guarantees high quality results without affecting the properties of the ingredients. It increases the profitability of the business as the equipment can be amortised in a few months.

¡Solicita una demostración!

¡Solicita una demostración!



La revolución de la cocina profesional  
The revolution in professional kitchens

**YouCook**



Qbo es para / Qbo is for:

## 01 ALIMENTACIÓN — FOOD INDUSTRY

Desde preparaciones básicas hasta platos terminados.

From basic preparation to finished, ready-to-serve meals.

## 02 PASTELERÍA — PASTRY

Qbo ofrece la precisión y detalle que busca este sector.

Qbo provides the precision and detail that this sector requires.

## 03 CHOCOLATE — CHOCOLATE

Se garantizan productos con propiedades organolépticas.

It guarantees products with perfect organoleptic characteristics.

## 04 HELADOS — ICE CREAMS

Pasteuriza, refina, emulsiona, concentra respetando la materia prima.

It pasteurises, refines, emulsifies and concentrates, respecting the raw materials.



01  
Salsas, cremas, carnes...  
Sauces, creams, meats...



02  
Confituras, mermeladas...  
Candied fruit, jams...



03  
Cremas, ganache, pralines...  
Creams, ganache, praline...



04  
Veteados, bases, toppings...  
Ripple ice cream, bases, toppings...

## CALIENTA Y COCINA HEATING AND COOKING

Trabaja a baja temperatura y en vacío, pero también a alta temperatura y a presión, lo que permite preservar la materia prima y reducir el tiempo de cocción.

Low temperature under vacuum and high temperature under pressure. The properties of the raw material are preserved and the cooking time is reduced.



## AMASA KNEADING

Tanto en frío como en caliente, logrando en pocos segundos texturas lisas y homogéneas.

Both cold and hot, achieving smooth and homogeneous textures in just a few seconds.



## ENFRÍA COOLING

A temperatura controlada y rápido, deteniendo la cocción al instante para evitar la sobrecocción.

At a controlled temperature and quickly, stopping the cooking instantly to avoid overcooking.



## REFINA REFINING

Sin sobrecalentar ni oxidar el producto, gracias al vacío y al enfriamiento controlado.

It works perfectly in both hot and cold temperatures, maintaining particle size with a gentle action.



## CONCENTRA Y EVAPORA CONCENTRATE & EVAPORATES

En vacío, por debajo de 100°C, para preservar la materia prima y obtener concentrados ultrarrápidos, hasta 10 veces más rápido que con métodos tradicionales.

In a vacuum, below 100°C, the raw material is preserved and ultra-fast concentrations are obtained, up to 10 times faster than with traditional methods.



## CORTA CUTTING

Corta con precisión regulando la velocidad según el tipo de corte, para obtener el tamaño ideal en productos de carne picada.

Cuts with precision by adjusting the speed according to the type of cut, to achieve the ideal size in minced meat products.



## GRANULA GRANULATION

Genera una textura fina con granulometría personalizada.  
Generates a fine texture with customised granulometry.



## EMULSIONA EMULSIFICATION

Gracias a la cocina al vacío, los productos mantienen una estructura perfecta y estable con el paso del tiempo y sin aire.  
The products come out with a perfect structure, stable over time and airless thanks to the vacuum process.



## MEZCLA BLENDING

Mezcla con precisión, utilizando herramientas diseñadas para conservar la integridad del corte, tanto en frío como durante la cocción.

Mixes with precision, using tools designed to preserve the integrity of the cut, both when cold and during cooking.



## PASTEURIZA PASTEURISATION

Con un sistema patentado de cocción por vapor indirecto que garantiza rapidez, control total y temperatura homogénea.

It uses a patented indirect steam cooking system. This ensures speed, total control and uniform temperature.



## MONTA Y AIREA WHISKING AND AERATION

Permite introducir aire, gases inertes o CO2 para elaborar productos aireados, suaves y espumosos.  
Allows the incorporation of air, inert gases or CO2 for airy, smooth and frothy products.



## FUNDE MELTING

Fusiones de mayor calidad en términos estructurales gracias al calentamiento controlado, el sistema al vacío y la potencia de mezclado.

Controlled heating, vacuum system and mixing power for structurally superior melted products.





## CONFITA CANDYING

Gracias al vacío, el proceso de ósmosis inversa se realiza en muy poco tiempo, siendo 15 veces más rápido que con métodos tradicionales. Permite obtener diferentes niveles de confitado.

It achieves different levels of candying. The osmosis process is up to 15 times faster than traditional methods. This is due to the vacuum process. It achieves different levels of candying.



## DISUELVE BLENDING

Gracias a la combinación de distintos utensilios al mismo tiempo, se consigue la máxima uniformidad durante el proceso de mezclado.

By combining several tools at the same time, the highest level of uniform mixing is achieved.



## HOMOGENEIZA HOMOGENISATION

Productos homogéneos y texturas cremosas gracias a la combinación de distintos factores dinámicos.

Combining several dynamic factors produces homogeneous and creamy results.



*Ventajas infinitas:  
Endless benefits:*

**MEJORA LA CALIDAD  
ELEVATES QUALITY**

Mantiene el sabor de la materia prima sin perder ninguna de sus propiedades a lo largo del proceso.  
It maintains the flavour of the raw material without losing any of its properties through the process.

**ASEGURA LA REPETIBILIDAD  
ENSURES REPLICABILITY**

Permite el control total de todo el proceso y la repetibilidad de las fórmulas.  
Allows the entire process to be monitored and ensures that recipes can be replicated.

**COCINA A PRESIÓN  
COOKING UNDER PRESSURE**

Acelera el tiempo de cocción, consiguiendo tiempos más cortos que los métodos convencionales.  
It speeds up the cooking time, achieving shorter cooking times than conventional methods.

**TRABAJA AL VACÍO  
WORKS IN VACUUM**

Elimina la oxidación y protege las cualidades de las materias primas.  
Eliminates oxidation and protects the qualities of the materials used.

**AUMENTA LA PRODUCTIVIDAD  
INCREASES PRODUCTIVITY**

Aporta valor al trabajo de los profesionales, permitiéndoles crear o experimentar más.  
It brings value to the work of professionals, allowing them to create or experiment more.

**EVAPORA A GRAN VELOCIDAD  
EVAPORATES AT HIGH SPEED**

Pudiendo reducir tiempos hasta 10 veces, en comparación a los métodos tradicionales.  
This can reduce times by up to ten times compared to traditional methods.

**ACELERA LA TRANSFORMACIÓN  
SPEED UPS PROCESSING**

Reduce las tensiones y ayuda a preservar la calidad del producto.  
It reduces stress and helps to preserve the quality of the product.

**PERSONALIZACIÓN  
CUSTOMISED PROCESSES**

Se adapta a todas las fórmulas y recetas.  
It adapts to all formulas and recipes.

**DATOS Y DOCUMENTACIÓN  
DATA AND DOCUMENTATION**

Recopila datos de los procesos, facilitando la planificación y la gestión del APPCC.  
It collects process data, facilitating HACCP planning and management.



Más, en menos tiempo  
More in less time



Ahorro de espacio  
Space-saving



Seguridad en producción  
Production safety



Respeto por los ingredientes  
Respect for ingredients



Tecnología todo en uno  
All in one technology



Autolimpieza  
Autocleaning



## Más comodidad / More comfort

Permite trabajar sin necesidad de campana extractora, ya que su sistema captura olores y vapores llevándolos al desagüe. Además permite una autolimpieza sencilla gracias a sus tres ciclos de lavado. Es ideal para empresas de cualquier tamaño, puesto que ofrece eficiencia, versatilidad y simplicidad de uso, incluso para usuarios con menos experiencia. También, cuenta con un servicio de asistencia técnica y asesoramiento que permitirá avanzar y descubrir esta nueva forma de trabajar.

It makes it possible to work without an extractor hood, as its system captures odours and vapours and directs them to the drain. It also allows easy self-cleaning thanks to its three washing cycles. It is ideal for businesses of all sizes, offering efficiency, versatility and ease of use, even for less experienced users. It also has a technical support and advice service to help you progress and discover this new way of working.

Versión / Version	de sobremesa / counter
Construcción / Construction	Inox AISI 316L
Volúmen de la bañera/ Bowl volume	5, 5 L
Tensión trifásica / Three-phase voltage	400 V / 50 Hz (230 V / 60 Hz)
Temperatura máxima / Max. temperature	115 °C
Dimensiones / Dimensions	700 x 570 x 710 mm
Peso neto / Net weight	75 Kg

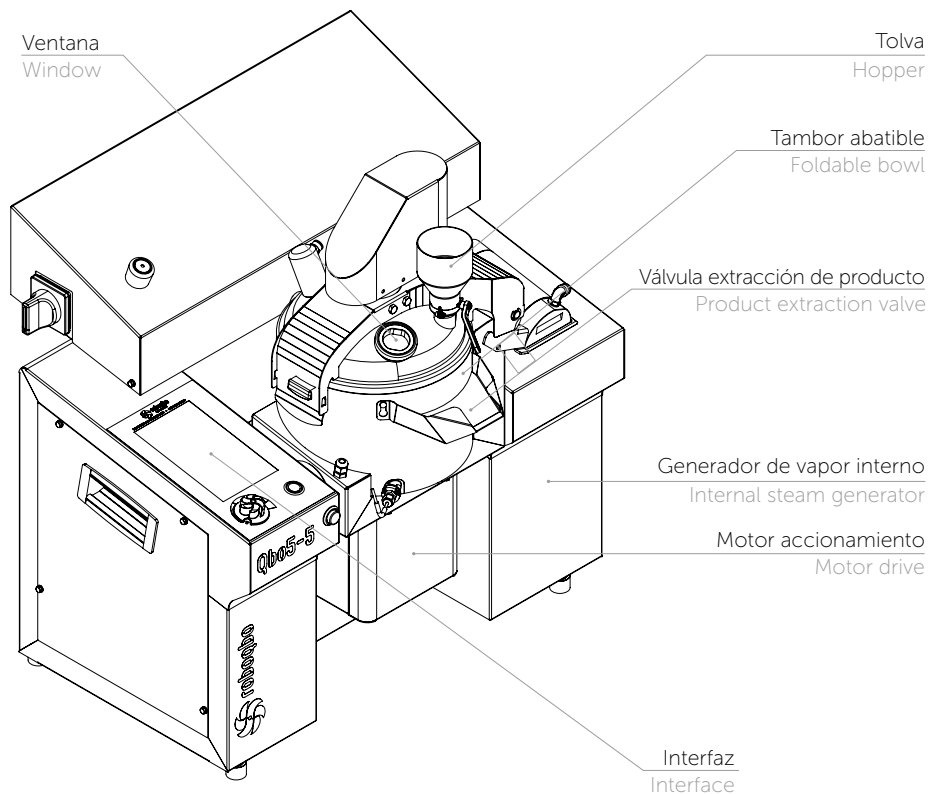

## Un software simplemente sencillo A simple and straightforward software

Qbo tiene una interfaz sencilla, intuitiva y completa que te permite obtener siempre el producto perfecto, con el control total del proceso con tan solo pulsar un botón.

Qbo has a simple, intuitive and comprehensive interface that allows you to get the perfect product every time, with full control of the process at the touch of a button.

**Qbo5 nos ofrece:**  
Qbo5 offers us:

**SO Windows:**  
Windows SO:

Gestiona los sistemas de la aplicación.

Which manages the applications.

**Diagnósticos:**  
Diagnostics:

Autodiagnósticos que detectan e informan anomalías.

Self-diagnostics that detect and report anomalies.

**Sistema HMI:**  
HMI System:

Interfaz para gestión, seguimiento y control a distancia.

Interface for remote management, tracking and control.

**Tech 4.0:**  
Tech 4.0:

Intercambio, descarga y diagramas de datos.

Exchange, download and data diagrams.

**Audio y voz:**  
Audio & voice:

Dispositivo para comunicarse con operadores.

Device to communicate with operators.

**Conexión WiFi:**  
WiFi connection:

Integrada y lista para su uso.

Integrated and ready to use.

QBO5 para la gastronomía  
QBO5 for gastronomy

**YouCook**



## Gama / Range

Además de la gama QBO5, la empresa cuenta con otros modelos de diferentes tamaños, que se adaptan a las necesidades de cada flujo de trabajo.

In addition to the QBO5 range, the company has other models of different sizes, which are adapted to the needs of each workflow.

MODELO MODEL	QBO5	QBO8	QBO15	QBO25	QBO40	QBO70	QBO120	QBO250	QBO350	QBO550	QBO860
VOLUMEN DE LA CUBA BOWL VOLUME	5.5 L	8 L	15 L	25 L	40 L	70 L	120 L	250 L	350 L	550 L	860 L
VERSIÓN VERSION	De mesa Table top		De suelo Floor standing								
TENSIÓN VOLTAGE	400V / 50 Hz (230V / 60 Hz)		400-220-200V 50/60 Hz								
TEMP MÁX. MAX. TEMP.	115°C		120°C								
VACÍO MAX. MAX. VACUUM	-990 mbar										
DIMENSIONES DIMENSIONS (mm)	L 700 x P 570 x H 710	L 848 x P 822 x H 840	L 1224 x P 953 x H 1429	L 1344 x P 1082 x H 1517	L 1498 x P 1063 x H 1580	L 1654 x P 1408 x H 1816	L 1994 x P 1596 x H 1801	L 2320 x P 1755 x H 2045	L 2705 x P 2038 x H 2370	L 2891 x P 2038 x H 2413	L 3132 x P 2140 x H 2571
PESO NETO NET WEIGHT (kg)	75	120/127	215/247	345/370	380/370	605/650	1100	1700	2400	2900	4000

Accesorios / Accessories



30/6002

Pala mezcladora  
Mixing tool

Mezcla el producto manteniendo el troceado inalterado, en frío y caliente.

Perfect mixes that maintain the chopping unchanged, in both cold and heat.



30/6003

Cuchilla lisa  
Smooth blade

Corta con precisión, consigue la granulometría perfecta, según la velocidad.

Precise cuts according to the speed, achieving the perfect granulometry.



30/6004

Cuchilla microdentada  
Micro-serrated blade

Refina y homogeneiza, aportando uniformidad para obtener texturas cremosas.

Refines and homogenizes, providing uniformity to achieve creamy textures.



30/6005

Aeroqbo

Monta y airea para elaborar productos aireados, suaves y espumosos.

Whips and aerates to create airy, smooth, and fluffy results.



30/6006

Disco emulsionador Leonardo  
Emulsifying disk Leonardo

Emulsiona, consiguiendo productos con estructura perfecta, estable y sin aire.

Emulsifies, achieving perfect and stable structure results, and with no air.



30/6007

Basquet

Accesorio dirigido a la confitería y la cocción al vapor.

Accessorie created for candy making and steaming.



30/6008

Cesto para confitar  
Basket for candying

Combinable con la cesta para confitar (max. 3 piezas).

Combinable with the candy making basket (max. 3 pieces).

30/6009

Alimentador para líquidos  
Liquid feeder

30/6012

Mesa Trolley  
Trolley Table

30/6010

Pulido de bol y tapa  
Bowl and lid polishing

30/6011

Limpiador para caldera (30 dosis unitarias)  
Boiler cleaner (30 unit doses)

# pacojet 4

La revolución de la pacotización®, más rápida, potente y silenciosa  
The pacotizing® revolution, faster, more powerful and quieter

Pacotizar® es un método único para transformar alimentos ultracongelados frescos en texturas ultrafinas en segundos, sin descongelar.

Pacojet 4 destaca por sus numerosas características nuevas, que incluyen la opción de Pacotizar® en solo 90 segundos. Una gran pantalla táctil ofrece una guía intuitiva al usuario, con guardado de recetas y nuevas funciones de seguridad y limpieza. La nueva Pacojet es excepcionalmente silenciosa y brinda resultados sobresalientes, garantizando una máxima productividad y rentabilidad.

Pacotize® is a unique method for transforming fresh deep-frozen foods into ultra-fine textures in seconds, without defrosting.

Pacojet 4 stands out for its many new features, including the option to Pacotize® in just 90 seconds. A large touch screen offers intuitive user guidance, recipe saving and new safety and cleaning functions. The new Pacojet is exceptionally quiet and delivers outstanding results, ensuring maximum productivity and profitability.

PJ4 System incluye: 1 Vaso sintético con tapa, 1 Cuchilla PJ4, 1 Vaso protector, 1 Protector salpicaduras

PJ4 System includes: 1 Synthetic beaker with lid, 1 PJ4 blade, 1 Protective beaker, 1 Spray guard

30/5000

PacoJet 4 System

1500 WATTS 220 V

50 x 20 cm

Altura / Height 36,5 cm



Conoce más sobre PacoJet 4  
Learn more about PacoJet 4

YouCook

Gran pantalla táctil  
Large touchscreen

Guardado de ajustes  
Settings saving

Nuevas funciones  
New features

Fácil limpieza  
Easy cleaning

Placa base desmontable  
Detachable base plate



1



### Preparar y llenar

Preparación sencilla de los ingredientes frescos: cortar en trozos y añadir líquido

2



### Congelar y guardar

Mínimo 24 horas a -20°C

3



### Pacotice® por raciones

Para servicio o mise en place

## ¿Cómo funciona?

### Presurización que multiplica resultados.

Gracias a su sistema exclusivo de presurización de hasta 1 bar dentro del vaso, Pacojet 4 aumenta el volumen de tus preparaciones de manera natural.

- Hasta un 20–30% más de volumen en sorbetes.
- Hasta un 10–45% más en mousses, purés y rellenos, según número de ciclos.

### Resultado:

- Sorbetes cremosos y estables, sin azúcares añadidos ni anticristalizantes.
- Mousses más ligeras y aireadas, con texturas imposibles de lograr con otros métodos.
- Ahorro real: más raciones con la misma cantidad de producto.

## How does it work?

### Pressurization that multiplies results.

Thanks to its exclusive pressurization system of up to 1 bar inside the beaker, Pacojet 4 increases the volume of your preparations in a natural way.

- Up to 20-30% more volume in sorbets.
- Up to 10-45% more in mousses, purees and fillings, depending on the number of cycles.

### Result:

- Creamy and stable sorbets, without added sugars or anti-crystallizers.
- Lighter and airier mousses, with textures impossible to achieve with other methods.
- Real savings: more servings with the same amount of product.





Helados y sorbetes  
Ice creams and sorbets



Mantequillas  
Butter



Puré, sopas y cremas  
Puree, soups and creams



Salsas y pestos  
Sauces and pestos



Mousses y nata  
Mousses and cream



Concentrados y aceites  
Concentrates and oils



Rellenos  
Fillings



Polvos y criofiltrados  
Powders and cryofiltrates



Zumos e infusiones  
Juices and infusions



Emulsiones  
Emulsions



Granizados  
Granita



Bebidas vegetales  
Vegetable beverages

## Aplicaciones / Applications

¿Ya usas Pacojet? Es hora de evolucionar:

Descubre lo que tu antigua Pacojet no puede ofrecerte.

- Función de presurización exclusiva: hasta 45% más volumen sin esfuerzo.
- Sorbetes perfectos sin aditivos ni azúcares extras.
- Mantiene cadena de frío intacta, máxima seguridad alimentaria.
- 90 segundos con el Modo Jet®: produce más, sirve más rápido.
- Hasta 10 ciclos automáticos: mousses perfectas sin supervisión.
- Mucho más silenciosa: úsala frente al cliente.
- Pantalla táctil intuitiva: cero curva de aprendizaje.

Already using Pacojet? It's time to evolve

Discover what your old Pacojet can't offer you.

- Función de presurización exclusiva: hasta 45% más volumen sin esfuerzo.
- Sorbetes perfectos sin aditivos ni azúcares extras.
- Mantiene cadena de frío intacta, máxima seguridad alimentaria.
- 90 segundos con el Modo Jet®: produce más, sirve más rápido.
- Hasta 10 ciclos automáticos: mousses perfectas sin supervisión.
- Mucho más silenciosa: úsala frente al cliente.
- Pantalla táctil intuitiva: cero curva de aprendizaje.



Inspiración y recetas  
Inspiration and recipes

YouCook



Pacojet Club



## Beneficios para tu negocio / Benefits for your business



### Aumenta tu rentabilidad / Increase your profitability

Reduce costes, evita desperdicios, congela la sobreproducción y prepara porciones exactas "a la carta" sin merma.  
Reduce costs, avoid waste, freeze overproduction and prepare exact portions "on demand" without shrinkage.



### Texturas perfectas / Perfect textures

Mousses, helados, sorbetes, sopas, salsas, pestos o rellenos siempre lisos, cremosos y sin cristales.  
Mousses, ice creams, sorbets, soups, sauces, pestos or fillings always smooth, creamy and without crystals.



### Productividad sin límites / Productivity without limits

Con el modo Jet® (90 segundos) podrás servir más rápido en horas pico o banquetes, sin renunciar a la calidad.  
With the Jet® mode (90 seconds) you can serve faster at peak times or banquets, without sacrificing quality.



### Versatilidad total / Total versatility

Un solo equipo que microtritura, bate, emulsiona, trocea o monta productos frescos o congelados.  
Perfecto para platos dulces, salados o incluso para innovar en coctelería.  
A single unit that micro-crushes, whips, emulsifies, chops or whips fresh or frozen products.  
Perfect for sweet and savory dishes or even for innovative cocktails.



### Calidad garantizada en cada servicio / Guaranteed quality in every service

Con presión normal o sobrepresión logras la textura exacta que buscas: ligera y cremosa o firme y compacta.  
Siempre reproducible, sin sorpresas  
With normal pressure or overpressure you achieve the exact texture you are looking for: light and creamy or firm and compact. Always reproducible, no surprises.



### Manejo intuitivo, limpieza rápida / Intuitive operation, fast cleaning

Pantalla táctil con guía visual, recetas preajustables y programa de autolimpieza. Ahorro de tiempo y personal.  
Touch screen with visual guidance, presettable recipes and self-cleaning program. Saves time and personnel.



### Silencio revolucionario / Revolutionary silence

Tan silenciosa que puedes colocarla en cocina abierta, barra o rincón sin afectar la experiencia de tus clientes.  
So quiet that you can place it in an open kitchen, bar or corner without affecting your customers' experience.





### 30/5024

Kit Nitro PJ4

Este kit, amplia el uso de Pacojet a la cocina molecular. Está diseñado especialmente para trabajar con nitrógeno líquido, permitiéndote crear texturas únicas.

Ideal para: Nieves ultra finas, polvos helados de frutas, especias...

This kit expands the use of Pacojet to molecular cuisine. It is specially designed to work with liquid nitrogen, allowing you to create unique textures.

Perfect for: Ultra-fine sorbets, frozen fruit powders, spices...

Incluye un vaso de acero y su protector, preparados para soportar las extremas temperaturas del nitrógeno.  
Includes a steel cup and its protector, designed to withstand the extreme temperatures of nitrogen.



Vasos sintéticos Pacotizing con tapa - Pacojet4

Synthetic Pacotizing beakers with lid - Pacojet4

30/5010

6 uds / pcs

30/5009

12 uds / pcs



### 30/5015

Vaso Pacotizar de acero con tapa

Pacotize steel beaker with lid



### 30/5014

Vaso protector PJ4 para acero cromado  
Protective beaker PJ4 for chrome steel



### 30/5016

Vaso protector PJ2Plus para vaso sintético  
Protective beaker PJ2Plus for synthetic cup



### 30/5019

Vaso protector PJ4 para envase sintético  
Protective beaker PJ4 for synthetic cup



### 30/5027

Vaso protector PJ2Plus para vaso cromado  
Protective beaker PJ2Plus chrome cup



### 30/5011

Cuchilla PJ4/PJ2 Plus  
PJ4/PJ2 Plus Blade

Transforma tu Pacojet 4 en un procesador de alimentos frescos.

Corta, bate, emulsiona, espuma o mezcla con la misma precisión suiza.

Cuchillas afiladas de precisión: Perfectas para picar carnes, pescados, verduras, hierbas, frutas, frutos secos y más.

Transform your Pacojet 4 into a fresh food processor. Chop, blend, emulsify, foam, or mix with the same Swiss precision.

Precision-sharpened blades: Perfect for chopping meat, fish, vegetables, herbs, fruit, nuts, and more.



30/5020  
Protector salpicaduras PJ4  
Splash guard PJ4



30/5022  
Raspador preliminar PJ4  
Preliminary scarper PJ4



30/5026  
Protector salpicaduras PJ2plus  
Splash guard PJ2plus



Pastillas de limpieza  
Cleaning tabs

30/5002 | 60 uds / pcs

30/5025 | 8 uds / pcs



### 30/5005

Coupé Set PJ4

Ideal para cremas, batidos, nata, claras, cócteles y espumas.

Ideal for creams, milkshakes, whipped cream, egg whites, cocktails, and foams.



Guía rápida  
Quick guide



Conviértete en un profesional de PacoJet4  
Become a PacoJet4 professional



Cómo limpiar tu Pacojet  
How to clean your Pacojet



# OCOO

## PRO SYSTEM

Máquina de doble  
cocción y presión  
automática

**OCOO-PRO** cocina aplicando el principio de la doble ebullición, con temperatura y presión controladas para extraer el máximo sabor. Se obtienen extractos con un sabor intenso, aptos a ser utilizados como pre-elaboraciones y también como platos finalizados. Los aromas de la cocción se concentran en el interior de la olla y se preservan las cualidades organolépticas de los alimentos.

Automatic double  
pressure boiler

**OCOO-PRO** cooks applying the double boiling principle and controls temperature and pressure to extract the maximum flavor. Obtain extracts with an intense taste, suitable to be used as pre-elaborations and also finished dishes. OCOO keeps the aromas of the food locked inside the pot and preserves the organoleptic characteristics of the food.

Olla interior de germanio con vaporera  
para gran producción  
Germanium inner cauldron with steamer  
for bigger production

Válvula doble de seguridad y presión  
Control de temperatura  
Safety and pressure double valves  
Temperature control



—  —  
Instrucciones en  
User manual in:  
EN - SP - FR - IT

Water level detection  
Detección del nivel de agua



Coliflor fermentada  
Fermented cauliflower

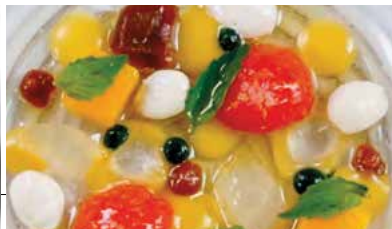

Vinagreta de mango  
Mango vinaigrette



Almendras supertiernas  
Supersoft almonds



Consomé de mango  
Mango consommé



Queso fresco  
Fresh cheese



Video-recetas de l restaurante Disfrutar  
Video recipes from Disfrutar restaurant



*"Después del impacto de la cocción a baja temperatura en la cocina OCOO es sin duda la nueva revolución que marcará nuestra época"*

*"After the impact of low-temperature cooking in our trade, OCOO is undoubtedly the next revolution that will mark our era."*

¿Qué puedo hacer con OCOO-PRO?  
What can I do with OCOO-PRO?

- |                                               |                      |
|-----------------------------------------------|----------------------|
| Elaboraciones<br>Pre-elaborations             | Bebidas<br>Drinks    |
| Salsas y Jarabes<br>Sauces and Syrups         | Guisos<br>Stews      |
| Fermentados<br>Fermentations                  | Pastelería<br>Pastry |
| Largas Cocciones<br>Slow Cooking              | Lácteos<br>Dairy     |
| Procesos de color<br>Color processes          |                      |
| Envejecimiento y Curado<br>Curing and Aging   |                      |
| Baja Temperatura<br>Low Temperature           |                      |
| Extractos y Consomé<br>Extracts and Consommés |                      |



OCOO-PRO 230 V 60 Hz

30/0020 RE - Rojo / Red

30/0021 BR - Negro / Black

USA plugin

OCOO-PRO 110 V 50 Hz

30/1020 RE - Rojo / Red

Power Potencia 800 W

Pressure Presión 78.4 kpa

Recambios y accesorios disponibles en:  
Spare parts and accesories available on:  
[www.100x100chef.com](http://www.100x100chef.com)



Patata negra  
Black potato



Huevo al vapor  
Steamed egg



Pichón al vacío  
Sous vide squab pigeon



"Apio-vainilla" con gorgonzola  
Gorgonzola "celery-vainilla"



Sandía como tomate  
Watermelon as tomato

Nutrición saludable · Dieta macrobiótica · Superalimentos probióticos · Dieta Anti-Oxidación · Menú para aumentar su inmunidad  
Healthy Nutrition · Macrobiotic Diet · Probiotic Superfood · Anti-Oxidation Dietetics · Boost Immunity Menu

# Enzyme+

## Fermentador Automático Multifunción Multi-functional Smart Fermenter

Enzyme+ es la solución definitiva para la fermentación controlada, la esterilización y desinfección, los procesos de secado y la cocción a fuego lento.

Permite una distribución tridimensional del calor y mantiene la temperatura uniforme tanto en los bordes laterales como en la parte alta. Gracias a su aislamiento evita la pérdida de calor reduciendo así el consumo de energía. Equipada con cesta de acero inoxidable con 2 niveles para maximizar la producción.

Cada programa puede ajustarse en temperatura y tiempo, para obtener efectos de sabor variados y satisfacer múltiples requisitos.

Enzyme+ is the ultimate solution for Controlled Fermentation, Sterilization and Disinfection, Drying & Simmering Processes.

It makes possible the three-dimensional heating around and at the top, with uniform internal temperature. Highly insulated, it prevents heat loss and thus reduces energy consumption. Equipped with multi-layered stainless-steel cage, to maximize the production.

Every program can be set to meet different taste effects and different time requirements by changing temperature and time.

Videos de técnicas y recetas  
Techniques and recipes videos

YouCook



Ajo negro y cebolla  
Black garlic & Onion



Enzimas  
Enzyme



Vinagre de frutas  
Fruit vinegar



Cocción a fuego lento  
Simmer



Vino de arroz dulce  
Sweet rice wine



**CONTROL DE TEMPERATURA**  
TEMPERATURE CONTROL



**MANTIENE EL CALOR**  
KEEP WARM



**DESHIDRATA**  
DEHYDRATE



**SISTEMA DESINFECTANTE**  
DISINFECTION SYSTEM

catalog 8 | www.100x100chef.com

**PROGRAMAS PRE-CONFIGURADOS:**

PRE-SET PROGRAMS:

Ajo Garlic	Vino dulce de arroz Sweet Rice Wine
Ajo Solo Solo Garlic	Encurtidos Pickles & Sourdough
Yogur Yogurt	Masa madre Drying & Heat
Natto Natto	Secado Preservation
Enzima Enzyme	Conservación por calor Simmer
Vinagre de frutas Fruit Vinegar	Desinfección a fuego lento Disinfection
Vino de frutas Fruit Wine	

Enzyme+

30/4000

220 - 240 V / 50Hz / 90 - 110 W

30/4001

110 V / 60 Hz / 90 - 110 W

29 Ø Alt / Height: 27 cm

Capacity **5 L**



LIBRE DE BPA  
BPA-FREE

MANTIENE EL CALOR 288 HORAS  
288 HOURS KEEP WARM

REGULADOR CON SOFISTICADA TECNOLOGÍA MICRO-COM  
FUZZY LOGIC MICRO-COM CONTROLLER



Yogur  
Yogurt



Producción de vino  
Home brewed wine



Masa madre  
Sourdough



Encurtidos y Kimchi  
Pickles & Kimchi



Natto

# hot mat

Superficie caliente para cocina y sala  
Hot surface for kitchen and dining area

Imagina poder mantener, moldear o emplatar sin perder la temperatura ni la textura perfecta. Con Hot Mat, eso ya es posible. Este tapete flexible con control de temperatura te permite trabajar azúcar, chocolate o masas sin lámparas, calentar baños maría o mantener platos listos para el pase.

No reseca, es antiadherente, enrollable y lavable. Siempre listo, donde lo necesites.  
Imagine being able to plate, mold, or prep without losing temperature or texture. With Hot Mat, it's now possible. This flexible, temperature-controlled mat lets you work with sugar, chocolate, doughs, or sauces, no lamps needed. It won't dry out food, it's non-stick, rollable, washable, and always ready, wherever you need it.



Tapete de silicona  
Silicone mat

Superficie calefactada  
Heating surface

Selector de 6 temperaturas hasta 100 °C  
6 temperature selector until 100 °C

## Hot Mat

30/0121	230 V
30/0122	110 V

61 x 40 x 2 cm



Conoce más  
Know more

**YouCook**





Baños térmicos  
Thermal bairs



Atemperado de chocolate  
Chocolate tempering



Moldeado de azúcares  
Sugar moulding



# buit

## Vaciador exprimidor Squeezer emptying

Buit te permite vaciar frutas y verduras de distintas texturas, desde la rigidez del coco hasta la jugosidad de una manzana, manteniendo la piel perfecta para usarla como recipiente natural.

Exprime su zumo, dale forma a su interior y sorprende con presentaciones únicas para cócteles, ceviches, sorbetes o lo que tu creatividad imagine.

Buit lets you hollow out fruits and vegetables of all textures—from the firmness of a coconut to the juiciness of an apple—while keeping the skin intact for use as a natural container.

Extract the juice, shape the inside, and amaze with unique presentations for cocktails, ceviches, sorbets, or whatever your creativity envisions.

30/3034

Buit

Incluye / it includes

2 cortadores de diferentes tamaños  
2 cutters of different sizes

220 V - 110 V

21 x 50 x 24 cm



Descubre lo fácil que es usar buit  
See how easily buit works

YouCook





30/3042

Recambio de cuchilla corta Buit  
Replacement of Buit short blade

30/3043

Recambio de cuchilla larga Buit  
Replacement of Buit long blade



# SLIMMER

## Plancha de presión mecánica

Nace como un *snack* callejero japonés, Slimmer es la herramienta que transforma cualquier ingrediente en una lámina fina, crujiente y sorprendente.

Diseñada con placas de aluminio teflonadas de temperatura independiente (hasta 240°C) y una capacidad de presión de hasta 2000 kg/cm<sup>2</sup>, Slimmer cuece, deshidrata y prensa al mismo tiempo, permitiendo lograr resultados visuales impactantes y texturas intensificadas.

Su tamaño de sobremesa y manejo sencillo la convierten en un instrumento versátil para cualquier cocina profesional o negocio gastronómico emergente.

## Slimmer teflon

30/3008	230 V
30/3009	110 V

2400 W



Videos de técnicas y uso  
Techniques and use videos

YouCook

## Mechanical iron press

Inspired by a Japanese street snack, Slimmer is a tool that transforms any ingredient into a thin, crispy and surprising sheet.

Designed with temperature-independent aluminum plates (up to 240 °C) and a pressure capacity of up to 2000 kg/cm<sup>2</sup>, Slimmer cooks, dehydrates and presses at the same time, allowing for stunning visual results and intensified textures.

Its tabletop size and easy handling make it a versatile tool for any professional kitchen or start-up catering business.

2000 Kgs / cm<sup>2</sup>  
CAPACIDAD DE PRESIÓN  
PRESS CAPACITY



## SLIMMER EN ACCIÓN:

En solo 2 minutos, Slimmer convierte ingredientes comunes en snacks completamente nuevos. Desde chips de queso o vegetales hasta bases moldeables para tacos o tartaletas, pasando por los "fósiles comestibles" con flores y hierbas incrustadas. Además, permite el prensado en frío para preparar *carpaccios* vegetales o frutas sin alterar su sabor original.

## SLIMMER IN ACTION:

In just 2 minutes, Slimmer turns common ingredients into completely new snacks. From cheese or vegetable chips to moldable bases for tacos or tartlets, to "edible fossils" with embedded flowers and herbs. It also allows cold pressing to prepare vegetable or fruit *carpaccios* without altering their original flavor.



## UTILIZA NUESTRAS HOJAS DE TEFLÓN USE OUR TEFLON SHEETS

30/3019

Teflón Slimmer  
Slimmer teflon

31 x 33 cm

6 uds  
pcs



## LA REVOLUCIÓN DE LA TEXTURA Y EL SABOR

- Gelatinización y caramelización controlada de almidones, azúcares y proteínas.
- Deshidratación rápida sin oxidación, que conserva color, aroma y nutrientes.
- Prensado uniforme hasta 1 mm de grosor, ideal para conseguir crujientes intensos y estables.
- Formación de láminas para texturas tipo cracker o suflado.

Slimmer ofrece un control total del resultado final, desde el grosor hasta la textura, pasando por el color y el aroma. Permite transformar alimentos sin aditivos, con máxima eficiencia y creatividad.

## CONTROL PRECISO DE TEMPERATURA EN CADA PLANCHA POR SEPARADO

### THE TEXTURE AND FLAVOR REVOLUTION

- Gelatinization and controlled caramelization of starches, sugars and proteins.
- Rapid dehydration without oxidation, preserving color, aroma and nutrients.
- Uniform pressing up to 1 mm thickness, ideal for intense and stable crispiness.
- Sheets for cracker-like or soufflé-like textures.

Slimmer offers total control of the final result, from thickness to texture, color and aroma. It allows food processing without additives, with maximum efficiency and creativity.

## PRECISE TEMPERATURE CONTROL ON EACH GRIDDLE INDEPENDENTLY



Deshidratación  
Dehydration



Suflado  
Soufflé



Prensado uniforme  
Uniform pressing



## APLICACIONES Y POSIBILIDADES ILIMITADAS

- *Snacks* vegetales crujientes, purés prensados y chips de frutas.
- Quesos curados laminados, con sabores y aromas intensificados.
- Preparaciones sufladas tipo pan de gamba, usando mezclas de tapioca y vegetales.
- Decoraciones técnicas y “fósiles” comestibles con elementos naturales visibles.
- Carpaccios en frío, ideales para menús frescos y saludables.
- Tartaletas y tacos prensados moldeables y crujientes.
- Oblats con polvo liofilizado o jarabes para snacks de alta intensidad.

## UNLIMITED APPLICATIONS AND POSSIBILITIES

- Crispy vegetable snacks, pressed purées, and fruit chips.
- Thinly pressed aged cheeses, with intensified flavors and aromas.
- Puffed preparations, like shrimp chips, using tapioca and vegetable mixes.
- Technical decorations and “edible fossils” with visible natural elements.
- Cold-pressed carpaccios, ideal for fresh and healthy menus.
- Pressed and moldable tartlets and tacos, crisp and shapable.
- Oblats with freeze-dried powders or syrups for high-intensity snacks.



Descarga la guía culinaria para Slimmer

Download the culinary guide for Slimmer

PDF ESP

PDF ENG

# SQUASHER

## Emulsionadora por presión

Intensifica líquidos con sabor, aroma y color, sin oxidación, sin calor y sin amargar.

A través de presiones precisas repetidas cientos de veces por minuto, permite infundir líquidos base, como agua, alcohol o aceites, con ingredientes sólidos, extrayendo aceites esenciales, compuestos aromáticos y notas delicadas sin arrastrar sabores indeseados.

El resultado: emulsiones limpias, intensas y homogéneas que conservan la frescura de los ingredientes.

## Pressure homogenizer

Squasher is a pressure-based emulsifier that intensifies base liquids with flavor, aroma, and color without heat, oxidation, or bitterness.

Using hundreds of precise pressure pulses per minute, it allows water, alcohol, or oil to be infused with solid ingredients, extracting essential oils, aromatic compounds, and delicate notes without unwanted flavors.

The result: clean, intense, and homogeneous emulsions that retain the freshness of every ingredient.

¡Ahora incluye luz! Sorprende a tus clientes con cada preparación gracias a su llamativo funcionamiento  
Now includes light! Surprise your customers with every preparation thanks to its eye-catching operation.

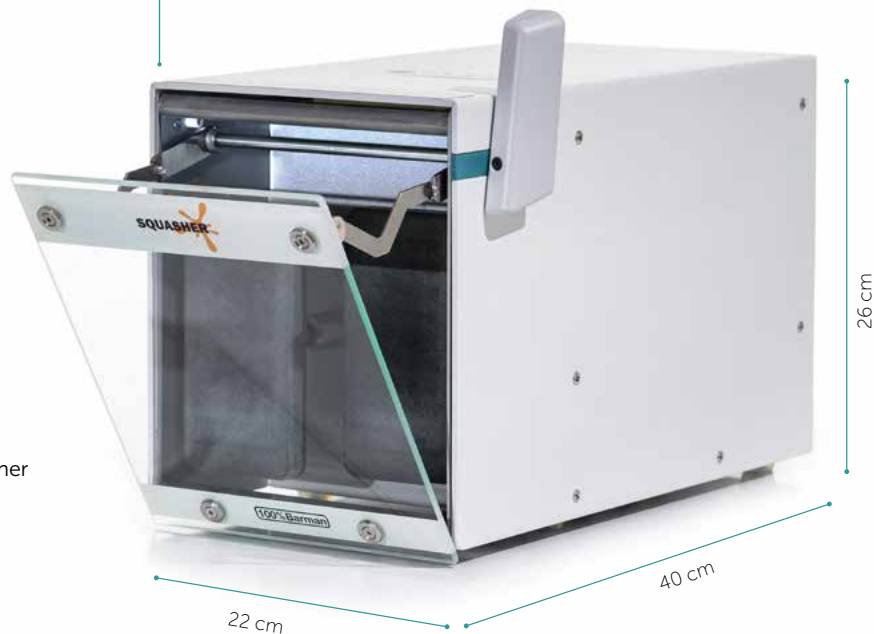

## SQUASHER

100/0200	100/0201
230V · 50Hz	110V · 60Hz



Recetas de cócteles con Squasher  
Cocktail recipes with Squasher

YouCook

100/0202

Bolsas con filtro  
Filter bags

50

uds  
pcs

Usa Squasher con bolsas con filtro interior de 100 µm, ideales para obtener líquidos sin posos ni necesidad de colado. Capacidad útil: 400 ml. (No aptas para cocción).

Use Squasher with bags featuring a 100 µm inner side filter, ideal for producing residue-free liquids with no need for straining. Usable capacity: 400 ml. (Not suitable for cooking).



100/0203

Soporte para bolsas  
Bag Holder

Ø 8 cm Alt / Height: 25 cm  
Base: Ø 15 x 0.6 cm



Frozen Margarita



Botones selección de tiempo: accesibles y fáciles de usar  
Time selection buttons: accessible and easy to use

2 palas que proporcionan emulsión en toda la superficie por igual  
2 paddles that provide emulsion on all surfaces equally

#### APLICACIONES VERSÁTILES

- Cócteles, infusiones, cordiales y caldos fríos o calientes.
- Leches vegetales, horchatas, té o café cold brew.
- Infusiones de nata o leche para bases de cremas y helados.
- Salsas grasas, pil-pil, holandesas o emulsiones con colágeno elaboradas *à la minute*.

#### VERSATILE APPLICATIONS

- Cocktails, infusions, cordials, and hot or cold broths.
- Plant-based milks, horchatas, cold brew coffee or tea.
- Cream or milk infusions for dessert bases and ice cream.
- *À la minute* emulsions for fatty sauces, pil-pil, hollandaise, or collagen-rich blends.

Made with **SQUASHER**





### ANTES / BEFORE CENTRICOOK



Piña Ananas  
Granada Pomegranate  
Tomate Tomato  
Perejil Parsley

### DESPUÉS / AFTER CENTRICOOK



Piña Ananas  
Granada Pomegranate  
Tomate Tomato  
Perejil Parsley

## Centrífuga culinaria

Pensada para realizar trabajos muy precisos en cocina y coctelería, CentriCook separa los zumos de las fibras en suspensión y las concentra en la base, donde queda la esencia más pura del alimento con una textura sedosa y casi impalpable (la pomada). En la parte superior queda el zumo o jugo clarificado, muy útil en coctelería para obtener cócteles clarificados y sin partículas en flotación. Clarifique todo tipo de jugos, zumos o aguas vegetativas sin necesidad de utilizar pectinasas o espesantes ni aumentar la temperatura. CentriCook acelera el proceso con respecto al uso de pectinasas o espesantes, sin calentar el producto. No acentúa la acidez y preserva de la oxidación. El producto final obtenido presenta un sabor más natural.

## Culinary Centrifuge

Designed for very precise work in cooking and cocktail making, CentriCook separates the juices from the suspended fibers and concentrates them at the base, where the purest essence of the food remains with a silky and almost impalpable texture (concentrated pulp). In the upper part remains the clarified juice, very useful in cocktails to obtain clarified cocktails without floating particles. Clarify all types of juices or vegetative waters without the need to use pectinases or thickeners or increase the temperature. CentriCook accelerates the process compared to the use of pectinases or thickeners, without heating the product. It does not accentuate acidity and preserves it from oxidation. The final product obtained has a more natural flavor.

## TAKE CLARIFICATION TO THE NEXT LEVEL WITHOUT PECTINASES!



## CLARIFICA HASTA 3 LITROS EN 10 MINUTOS

Alcanza 4000 RPM en menos de 15 segundos,

## CLARIFIES UP TO 3 LITERS IN 10 MINUTES

It reaches 4000 RPM in less than 15 second,

Fresa  
Strawberry

Agua de Fresa  
Strawberry Water

Pulpa pura de Fresa  
Strawberry Pure Pulp



En este caso, hemos clarificado agua de fresa, consiguiendo una agua con sabor y transparente y un residuo de una pulpa llamada mantequilla de fresa donde encontramos el sabor de la fruta de forma muy intensa.

In this case, we have clarified strawberry water, obtaining a flavored, transparent water and a residue of pulp called strawberry butter, where we find the very intense flavor of the fruit.



Descubre cómo se usa Centricook  
Discover how it works Centricook

YouCook



### CENTRICOOK

30/3000 230V	30/3007 110V
-----------------	-----------------

1 L. capacidad / capacity

 Incluye 4 envases de 250 ml.  
Includes 4 containers of 250 ml.

### CENTRICOOK XL

30/3012 230V	30/3020 110V
-----------------	-----------------

3 L. capacidad / capacity

 Incluye 4 envases de 800 ml.  
Includes 4 containers of 800 ml.





¡Centrifuga también en frío!  
Centrifuge in cold too!

Centrifugadora refrigerada de alta velocidad que redefine el procesamiento de líquidos naturales. Alcanza las 5000 RPM en menos de 15 segundos, permitiendo clarificar zumos, jugos o aguas vegetativas sin necesidad de calor, espesantes ni enzimas como las pectinasas. A diferencia de otros métodos, su velocidad genera fricción y calor... pero aquí es donde entra su ventaja: un potente sistema de refrigeración a -20 °C enfría el aire de forma activa, contrarrestando la oxidación, preservando el sabor natural, y acelerando la coagulación de grasas y partículas para una separación más limpia y estable.

High-speed refrigerated centrifuge that redefines the processing of natural liquids. It reaches 5000 RPM in less than 15 seconds, enabling the clarification of juices or vegetal waters without the need for heat, thickeners, or enzymes like pectinases. Unlike other methods, its speed generates friction and heat... but here's where it stands out: a powerful cooling system at -20 °C actively chills the air, counteracting oxidation, preserving the natural flavor, and accelerating the coagulation of fats and particles for a cleaner, more stable separation.



**SIN CALOR - SIN ADITIVOS - SIN OXIDACIÓN**  
NO HEAT - NO ADDITIVES - NO OXIDATION

**PRESERVA COLOR - AROMA - SABOR NATURAL**  
PRESERVES NATURAL COLOR - AROMA - FLAVOR

**5000 RPM**

**TEMPERATURA DE TRABAJO**  
OPERATING TEMPERATURE RANGE

 **-20°C**

**IDEAL PARA FAT WASH**  
IDEAL FOR FAT WASH

CENTRICOOK CHILLER

30/3022

220V 50hz 10A

1 L. capacidad / capacity

 Incluye 4 envases de 250 ml.  
Includes 4 containers of 250 ml.



30/3001

Botellas Centricook 250 ml  
CentriCook Bottles 250 ml

12 uds  
pcs

Compatible con / with:

CentriCook Ref: 30/3000 - 30/3007

CentriCook Chiller Ref: 30/3022



30/3014

Botellas Centricook XL 750 ml  
CentriCook XL Bottles 750 ml

4 uds  
pcs

Compatible con / with:

CentriCook XL Ref: 30/3012



30/3021

Botellas Centricook XL Wide Mouth 750 ml  
750 ml CentriCook XL Bottles Wide Mouth

4 uds  
pcs

Compatible con / with:

CentriCook XL Ref: 30/3012



## BRÛLÉE

Soplete de cocina profesional  
Professional culinary torch

Cabezal de soplete profesional compatible con todas las botellas de gas azul desechables. Seguro, preciso y regulable con una sola mano, trabaja inclinado sin perder potencia ni precisión.

Professional torch head compatible with all disposable blue gas canisters. Safe, precise, and adjustable with one hand, it works at an angle without losing power or accuracy.



Firepower  
1300°C

30/0004

Soplete de cocina profesional  
Professional culinary torch



120/0058  
Torch jacket

Ø 7 x 16 cm

Ajusta con cartuchos de gas Ø 66 mm  
Fácil de colocar y ajustar

Adjusts to Ø 66 mm gas cartridges  
Easy to install and adjust

## TORCH JACKET

Embellecedor para soplete de cocina  
Kitchen stove embellishment

Funda de polipiel negra diseñada para cubrir el cartucho de gas, ofreciendo una presentación impecable frente al cliente.

Torch jacket convierte un utensilio técnico en un elemento estético integrado en la experiencia gastronómica.

Black faux leather cover designed to conceal the gas cartridge, offering an impeccable presentation to the customer.

Torch Jacket transforms a technical tool into an aesthetic element that is integrated into the dining experience.



# BRULEE MAX

Soplete de de doble uso  
Double-use culinary torch

La llama concentrada tiene mayor poder calorífico que los sopletes comunes de cocina permitiendo sellar proteínas, marcar piezas grandes, complementar cocciones unilaterales, acelerar encendidos de carbón...

La campana difusora expande la superficie de cocción y ofrece un calor regular y consistente, evitando el sabor derivado de sopletear los alimentos.

¡Con Brulee Max tendremos precisión y sabor en cada plato!

The concentrated flame has a higher heat output than regular kitchen torches, allowing for the searing of proteins, marking large pieces, enhancing one-sided cooking, and accelerating charcoal ignition...

The diffuser bell expands the cooking surface and provides even and consistent heat, preventing the flavor derived from torching the food.

With Brulee Max, we'll have precision and flavor in every dish!



30/0200  
Brulee Max

15 x 7 cm  
Alt / Height: 31 cm

30/0201  
Rejillas recambio Brulee Max  
Brulee Max replacement grids

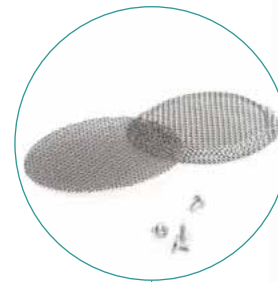

 Firepower  
1300°C - 1980°C

 **M**  
MAP-PRO

 **P**  
PROPANE

Base de seguridad anticaída  
Anti-fall and safety base

## LINTERNA DE LUZ NEGRA BLACK LIGHT LANTERN

Ideal para detectar espinas o cáscaras de marisco dentro de farsas o picadillos. Las cáscaras de marisco y espinas de pescado contienen elementos fluorescentes que la linterna de luz negra resalta y permiten ser detectados en ambientes de cierta oscuridad.

Ideal for detecting spines or shells of shellfish in farces or hash. Shells of fish and fish bones contain fluorescent elements that will glow in the dark thanks to this light, permitting you to take them off easily.

¡Elaboraciones de pescado y marisco IMPECABLES!  
PERFECT preparation of fish and seafood!



30/0007

Luz negra linterna  
Black light lantern

16 x 6 cm  
Alt / Height: 2 cm

## TORCHIETTO

Prensa de 5 litros para extracción en frío  
5-liter cold press

Prensa de tornillo de jugo a presión para frutas, verduras y salsas sin necesidad de añadir temperatura.

Es ideal para obtener extractos puros y concentrados sin alterar los sabores ni los nutrientes de los ingredientes. Permite extraer zumos de frutas maduras, así como para extraer agua vegetativa de pimientos asados, por ejemplo, o para segundas extracciones de zumos.

Screw press is ideal for juicing fruit, vegetables and sauces without adding heat.

It is ideal for obtaining pure, concentrated extracts without altering the flavour or nutritional value of the ingredients. It can be used to extract juice from ripe fruit and vegetable water from roasted peppers, for example, as well as for second juice extractions.

100/0204 5 L  
Torchietto

Cesta de acero inoxidable  
Base antideslizante  
Stainless steel basket  
Non-slip base





Omega Megamouth MMV700S

Peso / Weight: 5 kg

Altura / Height: 47 cm

Voltage: 230 V / 50-60 Hz

POWER BLENDER



Blender Omega 3HP

Peso / Weight: 3.4 kg

Dimensiones / Size: Ø 20 x 30 cm

Voltage: 230-240V / 50-60Hz

1500 Watts

SPECIAL SMOOTHIES

- MANZANAS** APPLES
- NARANJAS** ORANGES
- PEPINOS** CUCUMBERS
- KIWI** KIWI
- TOMATES** TOMATOES
- PERAS** PEARS

50/0016

Omega Megamouth MMV700S  
Slow Juicer

60 RPM

INTRODUZCA EL FRUTO ENTERO  
PUT IN THE WHOLE FRUIT

AHORRE TIEMPO DE PREPARACIÓN  
SAVE TIME DURING PREPARATION

ZUMOS SIN OXIDACIÓN  
HASTA 72 HORAS  
JUICES FREE FROM  
OXIDATION UP TO 72H

50/0009.1

Blender Omega OM6562SF 3HP

VASO DE 2L DE  
CO-POLYESTER  
SUPER-RESISTENTE  
HIGH RESISTANCE 2-L GLASS  
MADE FROM CO-POLYESTER

CUCHILLAS ESPECIALES  
DE ACERO  
STAINLESS STEEL CROSS KNIFE

CONTROLES PRECISOS  
POWER CONTROLS

Sistema AUTO-CLEANING durante la producción de jugo, para aumentar la eficiencia.

The AUTO-CLEANING system during the juicing process increases the performance.



Trabaje con un segundo vaso  
Work with two cups

50/0012

Vaso de recambio con cuchillo y tapa  
Cup and Lid Replacement



## SLOW JUICERS TECHNOLOGY

Fácil limpieza  
Easy cleaning



Botón de seguridad  
Safety switch

Cepillo rotatorio  
Rotating brush



Salida zumo  
Juice outlet

Motor de baja velocidad  
Silencioso y duradero.



Low Speed AC Motor  
Quiet and stronger.

Pieles de  
20 tomates cherry  
Amount of leftovers  
from 20 cherry tomatoes

Textura desligada  
Separate texture



Exprimidora tradicional  
Traditional juicer



+ 30%

Textura homogénea  
Homogeneous texture



Exprimidora Omega  
Omega slow juicer



**Omega  
Low Speed  
Technology  
System (LSTS)**

Tornillo condensador  
Condensing screw

Salida pulpa  
Pulp outlet



Omega Slow Juicer  
VRT402HDS

YouCook

50/0010

Omega Juicer VSJ843RS

80 RPM

CLASSIC SLOW



8227 Nutrition Center Juicer

Peso / Weight: 9.7 kg

Dimensiones / Size: 16.5 x 37 cm

Altura / Height: 40 cm

Voltage: 230 V / 50-60 Hz

EXPRIME  
EXTRACTS JUICE

PICA  
MINCES

MUELE  
GRINDS

EXTRUDA PASTA  
EXTRUDES PASTA

HACE LECHE DE SOJA  
MAKES SOY MILK

MANTEQUILLA DE CACAHUETES  
NUT BUTTER

POSTRES HELADOS  
FROZEN DESSERT MAKER

**DURADERA**  
DURABLE

**VERSÁTIL**  
VERSATILE

**POTENTE**  
POWERFUL

**SIMPLE**  
SIMPLE

SPECIAL FIBERS

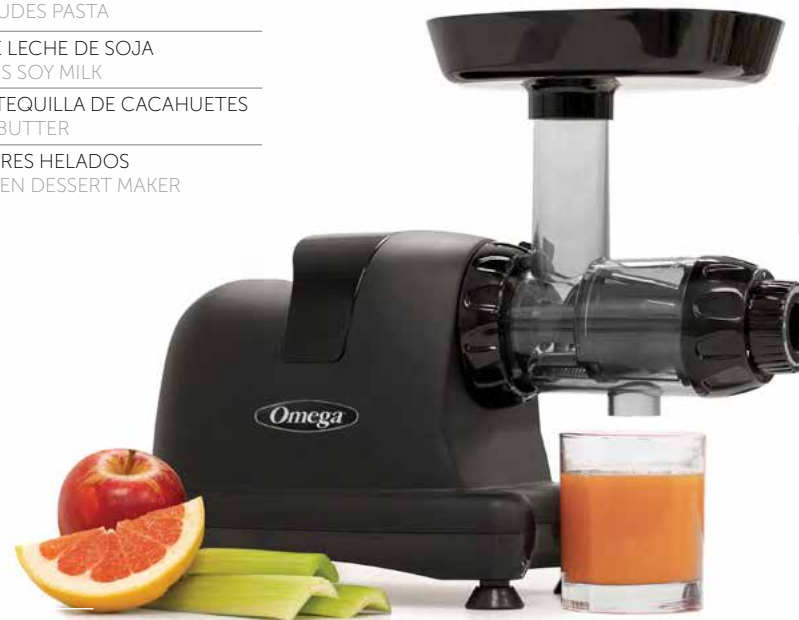

50/0035.1  
Extractor de jugos  
Masticating juicer

# claribag

## Bolsas de filtrado y clarificación Filtration and clarification bags

Estameñas fabricadas 100% de poliamida, un material sedoso y maleable, apto para el uso alimentario.

Puedes escoger entre 9 bolsas de diferentes tamaños y formas. Todas están equipadas con un aro de acero inoxidable para facilitar su llenado, asas para colgarlas y una etiqueta que identifica el modelo y grado de filtraje. Además resisten temperaturas de hasta 150°C.

No tienen costuras visibles, ni bordes de algodón o refuerzos de tela, lo que permite una limpieza mucho más fácil, garantizando que siempre estén listas para volver a ser utilizadas.

Cloth filters made from 100% polyamide, a silky, malleable material suitable for food use.

There are 9 bags to choose from, in a variety of sizes and shapes. Each bag is equipped with a stainless steel ring for easy filling, handles for hanging and a label identifying the model and filtration grade. They can also withstand temperatures of up to 150°C.

With no visible seams, cotton edges or fabric reinforcements, they are much easier to clean and are always ready for reuse.

### Modelos / Models

A	30/2004	Mini 100 µm	Ø 10 x 23 cm / 2 L
B	30/2008	Mini 50 µm	Ø 10 x 23 cm / 2 L
C	30/2002	Sauce 100 µm	Ø 18 x 45 cm / 8 L
D	30/2001	Sauce 250 µm	Ø 18 x 45 cm / 8 L
E	30/2003	Juice 100 µm	Ø 15 x 32 cm / 4 L
F	30/2000	Consomé 250 µm	Ø 36 x 56 cm / 52 L
G	30/2006	Long 100 µm	Ø 18 x 82 cm / 15 L

**Nuevo formato Mini 50 µm especial clarificados extremos.**  
New Mini 50 µm format, specially designed for extreme clarifications.

¡Ahorra esfuerzo y aprovecha al máximo las materias primas!  
Save effort and make the most of your raw materials!





30/2005  
Conik 100 µm

6 L

Ø 29 x 29 cm  
Para coladores cónicos  
For conical strainers



30/2007  
OCOO Bag 100 µm

8 L

Ø 20 x 24 cm  
Especial OCOO - PRO: elabore  
caldos e infusiones clarificadas  
extrayendo todavía mucho más.

Special OCOO - PRO: making  
broths and clarified infusions,  
extracting even more.



Carbonatación con cápsulas o cilindros de CO<sub>2</sub>  
Carbonation with CO<sub>2</sub> capsules or cylinders



Robusto: Acero inox 304  
Robust: 304 stainless steel

Portátil: asas integradas y  
diseño compacto  
Portable: integrated handles  
and compact design

## KEGG

### Sistema de carbonatación Carbonation System

El sistema Kegg te permite carbonatar, almacenar y servir tus bebidas. Un conjunto modular que combina barriles compactos, un tirador profesional y un kit de CO<sub>2</sub> diseñado para ofrecer control absoluto de la presión, ya sea en barriles o en botellas de plástico estandarizadas.

The Kegg system lets you carbonate, store, and serve your favorite beverages. This modular setup combines compact stainless-steel kegs, a professional tap connector, and a CO<sub>2</sub> kit designed to give you complete pressure control, whether you're carbonating in kegs or standard soft-drink bottles.

### Barril de carbonatación / Carbonation keg

Carbonata de forma natural o forzada, alcanzando hasta 30 psi sin esfuerzo. La boca roscada con entrada de gas y salida para grifería garantiza compatibilidad total con sistemas de dispensación. Disponible en 5 L y 10 L, es ideal tanto para elaborar como para almacenar y transportar bebidas carbonatadas con total seguridad.

Perfect for natural or forced carbonation, reaching up to 30 psi with ease. The threaded opening with dedicated gas and liquid ports ensures full compatibility with dispensing systems. Available in 5 L and 10 L, it's ideal for carbonating, storing, and transporting sparkling beverages safely and efficiently.

### Barril de carbonatación Carbonation Keg

100/0225

5 L

100/0226

10 L



Tutorial práctico  
Practical tutorial

YouCook

The ideal solution for carbonating beers and other beverages naturally with dextrose or forced carbonation, reaching up to 30 PSI.

100/0228  
Kit de carbonatación CO<sub>2</sub>  
CO<sub>2</sub> carbonation kit



## Kit de Carbonatación CO<sub>2</sub> para barril o botella CO<sub>2</sub> Carbonation Kit for keg or bottle

Solución versátil, segura y fácil de usar para **gasificar cualquier bebida**, con cápsulas o cilindros de CO<sub>2</sub> estándar. Nosotros aconsejamos los cilindros SodaStream®. Este kit permite una regulación precisa de presión (hasa 30 PSI) en barriles o botellas de plástico con rosca PCO 1881.

Para una **carbonatación segura en botellas de plástico** serán necesarios los **tapones con rosca Kegg**. Estos evitarán fugas de gas y permitirán la conexión a la botella con el kit.

A versatile, safe and easy-to-use solution for carbonating any beverage using standard CO<sub>2</sub> capsules or cylinders. We recommend using SodaStream® cylinders. This kit enables precise pressure regulation (up to 30 PSI) in kegs or plastic bottles with PCO 1881 threading.

To ensure safe carbonation in plastic bottles, Kegg threaded caps are required. These prevent gas leaks and enable connection to the bottle using the kit.

## Tirador para barriles Kegg / Kegg barrel handle

Sirve bebidas manteniendo siempre una **presión estable**, incluso mientras se sigue inyectando gas. Puede retirarse sin perder presión, facilitando un uso práctico y fiable en cualquier entorno.

Dispense drinks while maintaining stable pressure, even as gas is added during service. It can be detached for cleaning without losing pressure, making it a practical and reliable tool in any setting.

100/0229  
Tirador para barriles Kegg (carga y servicio)  
Kegg barrel handle (loading and serving)



30/0227  
Tapón rosca Kegg  
Kegg screw cap

5 uds  
pcs





Produce aires y pompas estables  
Produce stable and even bubbles

YouCook

# foamkit deluxe

50/0052

Foam Kit



Nuevo manual con técnicas y recetas incluidas  
New manual with techniques and recipes included



BOQUILLAS  
NORMALES  
COMMON  
NOZZLES



FOAM KIT

Acero inoxidable AISI 316  
Stainless steel nozzle



## Producción sencilla de aires y espumas

Cree en segundos "aires" homogéneos y estables, de forma continuada o de forma puntual, sin túrmix. Produzca aires con lecitina de soja, sucroester, o agentes espumantes, además de airear grasas fundidas. Foam Kit permite con muy poca cantidad de líquido, recoger tanta espuma como necesite controlando su producción tan solo pulsando un botón, sin necesidad de enchufes o cables, ya que funciona con 2 pilas. La base aireadora de acero inoxidable, garantiza una producción estable y de gran calidad, y permite una limpieza estricta después de cada producción.

## The easiest way to create foams and airs

Obtain homogeneous and stable foams within seconds with this special filter foamer without needing an immersion blender. It works even with small amounts of liquid. Add any foaming agent or stabilizer, as soy lecithin, sucroester. It works also with melted fat. Make as much foam as you want, controlling the production just by pushing a button. The compressor is operated by two batteries, so the device can be used anywhere.

The Foam-Kit nozzle is made with food-grade stainless steel that makes it really easy to clean thoroughly.



FOAM KIT + SOY LECITINE

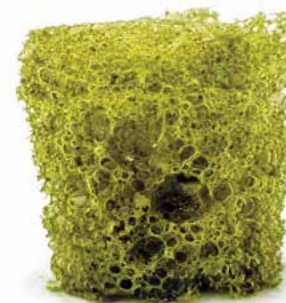

EXTRA VIRGIN OLIVE OIL AIR



30/0005  
Air Kit 2 \*

Ø 20 mm    Ø 17 mm    Ø 5 mm    Ø 3 mm



Tubos dispensadores  
Dispenser tubes

Agujas  
Needles

Spaghetti Kit

### Sujetasifón Whip Support

Aumenta el rendimiento un 25%, aprovechando al máximo el producto.

Increase the yield of the recipe up to 25%, taking the most advantage of your preparations.

30/0006  
Sujetasifón  
Whipper support



### Cargas sifón N2O N2O Whip Charges

30/0012    10 uds pcs

30/0012-B    360 uds pcs

8 g



30/0010    10 uds pcs  
Cargas Sifón CO2  
CO2 Whip Charges

## Air-Kit 3<sup>®</sup>

### Porta Boquilla Universal Universal Piping Tip

1 sola conexión para infinitas boquillas.  
1 unique adapter for infinite piping tips



Solo para boquillas de Ø 32 mm  
Only for Ø 32 mm piping tip

30/0009  
Air Kit 3 \*  
Ø 32 mm



MODELO  
PATENTADO  
PATENTED  
MODEL

Boquillas no incluidas / Piping tips not included



70/0077  
LYO CHEF - PRO

7 bandejas / trays  
Motor: 230 V / 50 - 60 Hz  
Potencia / power: 1,87 kW

## Liofilizadora para hostelería Freeze dryer for hospitality

LYO CHEF es la nueva liofilizadora diseñada por 100% Chef para llevar la liofilización al ritmo real de la hostelería profesional. El objetivo ha sido claro: obtener un equipo potente, preciso y fácil de usar, evitando la complejidad y el coste de los sistemas de laboratorio. El resultado es una máquina pensada desde cero para cocineros, cocteleros y reposteros, con un control absoluto del proceso, una interfaz intuitiva y la capacidad de ajustar cualquier parámetro incluso con el programa en marcha.

LYO CHEF is the new freeze dryer created by 100% Chef to bring freeze drying into the real workflow of hospitality. The goal was clear: deliver a powerful, precise and easy to use machine without the complexity or cost of laboratory equipment. The result is a unit designed from scratch for chefs, offering complete control of the process, an intuitive interface and the ability to adjust any parameter even while the program is running.





## Cómo funciona

### Sublimación: la base del proceso

LYO CHEF trabaja con el principio esencial de la liofilización. El alimento se congela y, bajo vacío extremo, el agua pasa directamente de hielo a vapor mediante pequeños impulsos de calor. El vapor queda atrapado en la trampa de frío, evitando que el producto vuelva al estado líquido y garantizando un **secado limpio y completo**.

### Control total para el cocinero

La máquina permite **ajustar cada parámetro en tiempo real**: temperatura de las bandejas, temperatura interna del alimento mediante la sonda externa y duración de cada etapa. También es posible **modificar tiempos** sin detener el programa y pausar para revisar el producto sin perder la configuración.

### Un ciclo preciso y eficiente

El sistema combina **congelación eficiente**, **secado estable** y un **vacío potente** que asegura una deshidratación completa en ciclos de entre 16 y 24 horas, según el tamaño y naturaleza del alimento.

Durante este tiempo, el producto pierde más del 90% de su peso y reduce su humedad a un 2%, un nivel que impide la acción de microorganismos y prolonga su conservación sin alterar sus características.

### Un resultado gastronómico potente

La combinación de congelación, vacío y desecación deja un **alimento ligero, crujiente** y con el **sabor muy concentrado**. Se deshace al contacto con la saliva y aporta aroma, textura y versatilidad. Puede usarse en polvo, trozos o entero para decoración, rellenos, chocolates, mantequillas, bebidas, postres, platos salados o ensaladas donde mantiene su punto crujiente.

## How it works

### Sublimation: the core of the process

LYO CHEF operates on the essential principle of freeze drying. The food is frozen and, under extreme vacuum, the ice turns directly into vapor through gentle heat impulses. The vapor is captured in the cold trap, preventing the product from returning to a liquid state and ensuring a **clean, complete dehydration**.

### Full control for the chef

The machine allows **real time adjustment of every parameter**: tray temperature, internal food temperature through the external probe and the duration of each stage. You can also **modify timings** without stopping the program and pause the cycle to check the product without losing the selected settings.

### A precise and efficient cycle

The system combines **efficient freezing**, **stable drying**, and a **powerful vacuum** that ensures complete dehydration in cycles of between 16 and 24 hours, depending on the size and nature of the food.

During this time, the product loses more than 90% of its weight and reduces its moisture content to 2%, a level that prevents the action of microorganisms and prolongs its preservation without altering its characteristics.

### A powerful gastronomic result

The combination of freezing, vacuum and controlled drying creates a **light, crisp product with highly concentrated flavor**. It melts on the palate and delivers aroma, texture and versatility. It can be used as powder, in pieces or whole for decoration, fillings, chocolates, butters, drinks, desserts, savory dishes or salads where it keeps its crunchy texture.



0,73 m<sup>2</sup> superficie de secado    18 kWh consumo energético  
7 kg carga por ciclo            por ciclo de liofilización  
0,5 mbar vacío máximo        18 kWh x 0,12 €\* = 2,16 € por ciclo

- Pantalla táctil intuitiva con configuración de preferencias del usuario
- 3 programas automáticos preestablecidos y programación personalizada con hasta 12 etapas con memoria para 20 programas propios
- Actualización software mediante USB
- Sonda externa para controlar la temperatura interna del alimento
- Sistema de detección individual de estantes calefactables
- Estantes calefactables extraíbles
- 7 bandejas extraíbles con hoja de teflón antiadherente
- Bomba de alto vacío de doble ciclo
- Puerta transparente ultrarreforzada
- Alarma por exceso de nivel de hielo
- Descongelación forzada de la trampa

0,73 m<sup>2</sup> drying area            18 kWh energy consumption per  
7 kg load per cycle            freeze-drying cycle  
0,5 mbar maximum vacuum    18 kWh x 0,12 €\* = 2,16 € per cycle

- Intuitive touchscreen with user preference configuration
- Three preset automatic programs and user defined programming with up to 12 stages, with a memory for 20 user created programs.
- USB software update capability
- Adjustable freezing and extra drying time
- External probe for monitoring internal food temperature
- Removable heated shelves
- 7 trays with teflon sheets
- Double cycle high vacuum pump
- Ultra-reinforced transparent door
- Ice level alarm
- Forced trap defrosting



## LYO CHEF benefits

LYO CHEF makes freeze drying accessible. It offers a **highly competitive price without sacrificing performance or reliability**, allowing restaurants, pastry shops, cocktail bars and creative labs to work with this technique without investing in laboratory-grade equipment.

Its interface is simple, the touchscreen is clear and the user can work with **automatic programs or create custom ones with up to 12 stages**, storing up to 20 personalized processes.

Users also benefit from **official technical support, a 12 month warranty and USB updates**. All this is in addition to a robust stainless steel design, side access for easy maintenance, and **digital management of warranties, manuals, updates, and exclusive content**.

With LYO CHEF, your kitchen gains precision, autonomy and a **wide new range of possibilities for preserving, transforming and creating**.

## Ventajas de LYO CHEF

LYO CHEF democratiza la liofilización. Ofrece un **precio altamente competitivo sin renunciar a rendimiento ni fiabilidad**, lo que permite incorporar esta técnica en restaurantes, obradores, coctelerías y talleres de creatividad sin necesidad de maquinaria de laboratorio.

Su manejo es sencillo, su pantalla táctil es clara y permite trabajar con **programas automáticos o personalizables de hasta 12 etapas**, con memoria para guardar hasta 20 procesos propios.

El usuario dispone además de **servicio técnico oficial, garantía de 12 meses y actualizaciones mediante USB**. Todo ello se suma a un diseño robusto en acero inoxidable, accesos laterales que facilitan el mantenimiento y **gestión digital de garantía, manuales, actualizaciones y contenido exclusivo**.

Con LYO CHEF, la cocina gana autonomía y precisión, y abre la puerta a una **nueva forma de conservar, transformar y crear**.



Antes (congelado a -40 °C) y después liofilizado / before (freezed at -40 °C) & after dry-freezed

Automatic program soft:

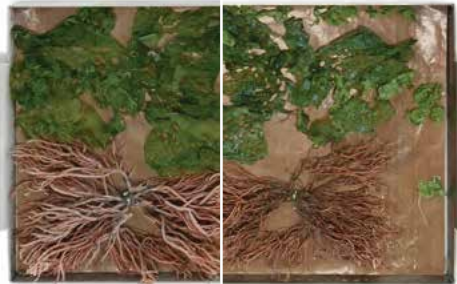

Automatic program regular:



Automatic program high:



### LYO CHEF incluye / includes

Bomba de alto vacío, aceite, filtro de aceite, jarra decantadora, 7 bandejas de acero inox, con 7 hojas de teflón.

Premium vacuum pump, oil, decanter jar, oil filter, stainless steel trays (5 or 6 depends on model), guide to freeze drying, Mylar bags (50 ct), oxygen absorbers (50 ct), impulse sealer 40 cm.



### Recambios / replacements

#### Aceite original LYO CHEF VPO-46H

Aceite sintético antiespumante y antidesgaste, especialmente formulado para liofilizadoras, que mejora el mantenimiento y el rendimiento de la bomba.

Es necesario cambiar o rellenar el aceite periódicamente para mantener la liofilizadora en condiciones óptimas. Por eso, este aceite está diseñado para una separación y evaporación del agua y presenta muy baja transmisión de olores, garantizando un funcionamiento limpio y eficiente.

#### Original LYO CHEF VPO-46H oil

This synthetic anti-foaming and anti-wear oil is specially formulated for use in freeze dryers. It improves pump maintenance and performance.

To keep the freeze dryer in optimal condition, the oil must be changed or topped up periodically. Designed for water separation and evaporation, this oil has very low odour transmission, ensuring clean and efficient operation.



Aprende a liofilizar  
Learn how to freeze-dry



70/0080  
Teflón LYO CHEF  
LYO CHEF teflon

7 uds  
pcs

70/0079  
Aceite recambio LYO CHEF  
LYO CHEF replacement oil

1 L

#### ADVERTENCIA

Si se utiliza aceite no idóneo o con una viscosidad inferior puede que no se alcancen los niveles de vacío en unos ciclo con lo que perjudicaremos el producto. Una excesiva viscosidad puede generar problemas en el arranque en frío.

#### WARNING

Using unsuitable oil or oil with a lower viscosity may prevent the vacuum levels from being reached in some cycles, which can damage the product. Excessively viscous oil can cause problems during cold starts.

# DryCook

## Deshidratador profesional Professional Dehydrator

Deshidratadores para uso profesional en cocina y pastelería. Controla la temperatura con una precisión de 0.5 grados desde 35 a 80°C. Deshidratación regular a gran escala con ventilación horizontal. Las bandejas regulables en altura permiten fermentar lácticos como yogurt, desecar todo tipo de frutas vegetales, especias para decorar o elaborar polvos, trabajos con azúcar, claras, Oblat®, secado de carnes y pescados, elaboración de hojas enteras, o bien pequeñas formas realizadas con Krokanters®. Al deshidratar por encima de los 75°C también permite trabajar con ovo-productos. Construido para durar, tiene unos motores muy silenciosos de gran rendimiento. Luz interior para ver el producto sin necesidad de abrir la puerta.

High-performance dehydrators for professional kitchens and pastry shops. Control the temperature with a 0.5 degrees precision of from 35 to 80°C (95 °F to 176 °F). Regular dehydration with large-scale production and horizontal ventilation. Height adjustable trays allow you to ferment dairy products like yoghurt, dry all kinds of fruits and vegetables, spices for decorating or making powders, work with sugar, egg whites, Oblat®, drying of meat and fish, processing of whole leaves, or small shapes made with Krokanters®. Dehydration above 75°C (167 °F) also allows you to work with ovo-products. Build to last, have high-performance and very quiet motors. Interior light to see the product without opening the door.



Tips y consejos de DryCook  
DryCook tips and advices

YouCook



10  
bandejas / trays

70/1000  
DRYCOOK

220V / 50 -60Hz 800 WATTS  
1 Ventilador / 1 Fan  
10 Bandejas / 10 Trays (30 x 28 cm)  
0.84 m<sup>2</sup> Producción / Production

15  
bandejas / trays

70/1001  
DRYCOOK XL

220V / 50 -60Hz 1500 WATTS  
2 Ventilador / 2 Fan  
15 Bandejas / 15 Trays (40 x 38 cm)  
2.28 m<sup>2</sup> Producción / Production





### DIGITAL CONTROL

	35 °C	◀ ▶	80 °C
	1 H	◀ ▶	24 H
	ON	◀ ▶	OFF

Entendiendo las exigencias de la alta producción en cocinas, en 100%Chef hemos creado las torres DryCook, un equipo que combina rendimiento, funcionalidad y diseño en un formato compacto y eficiente, optimizando el área de trabajo de tu obrador. Podrás optar por una configuración de 2 o 3 módulos que permiten control independiente de cada unidad.

Understanding the demands of high-production kitchens, at 100%Chef we have created the DryCook towers—equipment that combines performance, functionality, and design in a compact and efficient format, optimizing the workspace of your bakery. You can choose a configuration of 2 or 3 modules, each allowing independent control.

70/1001-2  
Capacidad 30 bandejas  
Capacity 30 trays

70/1001-3  
Capacidad 45 bandejas  
Capacity 45 trays

**45 BANDEJAS / TRAYS**  
**6,84m<sup>2</sup> PRODUCCIÓN / PRODUCTION** ▶  
**3 TEMPERATURAS / TEMPERATURES**

**30 BANDEJAS / TRAYS**  
**4,56m<sup>2</sup> PRODUCCIÓN / PRODUCTION** ▼  
**2 TEMPERATURAS / TEMPERATURES**

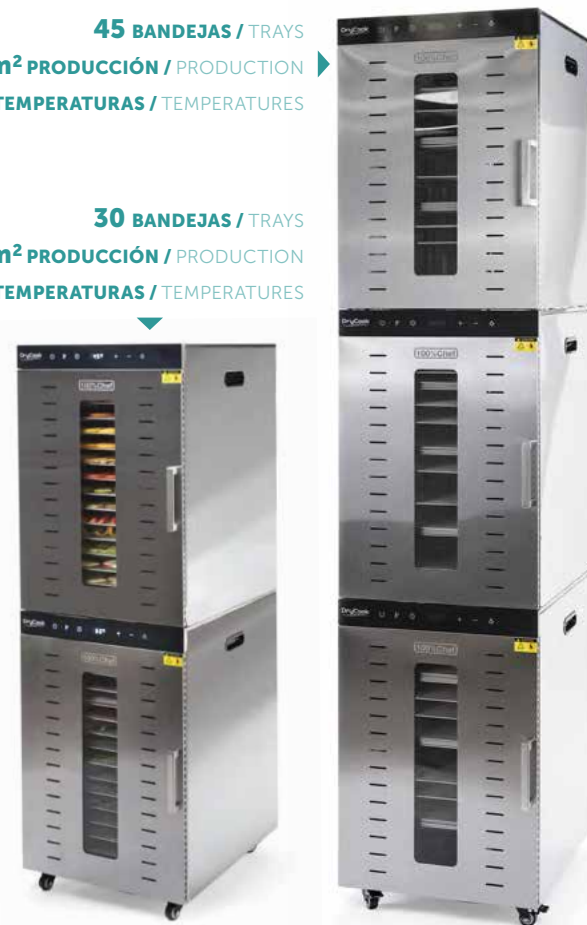

## Accesorios y complementos Accessories & Complements



Compatible with Plantillas Krokanters  
Use with Krokanters Stencil



Hojas de Teflón laminada de 150 µm y antiadherente por ambas caras. Garantiza más de 500 usos.

150 µm laminated Teflon sheets, non-stick on both sides. Guaranteed for over 500 uses.



Rejilla de silicona que facilita el paso de aire sin que vuelen por la acción del secado. Perfecto para productos delicados como flores y Oblat.

Silicone grid that allows air to pass through without items flying due to drying action. Perfect for delicate products such as flowers and Oblat.



Rejilla de recambio de acero inoxidable. Resistente, reutilizable, fácil de limpiar y aptas para el contacto alimentario.

Stainless steel replacement grid. Resistant, reusable, easy to clean, and food-safe.

70/1002  
Hoja de teflón DryCook XS  
Non-stick Teflon Sheet

5 uds  
pcs

70/1004  
Hoja rejilla de silicona DryCook XS  
DryCook silicone grid sheet XS

5 uds  
pcs

70/1006  
Rejilla acero inoxidable  
Stainless-steel grid

Medidas / Measurements 30 x 28 cm For: 70/1000 DryCook, 70/0012 Excalibur 2400

70/1003  
Hoja de teflón DryCook XL  
Non-stick Teflon Sheet

5 uds  
pcs

70/1005  
Hoja rejilla de silicona DryCook XL  
DryCook silicone grid sheet XL

5 uds  
pcs

70/1007  
Rejilla acero inoxidable  
Stainless-steel grid

Medidas / Measurements 40 x 38 cm For: 70/1001 DryCook XL



## Desidratador profesional de alimentos Digital food dehydrator

Este nuevo modelo presenta un diseño interno mejorado que aprovecha eficazmente el calor generado por las resistencias laterales para proporcionar un reparto de temperatura más constante. Con su control digital podrá programar con precisión hasta un máximo de 72 horas.

This new model has an improved internal design that efficiently uses the heat generated by the side heating elements to provide a more even temperature distribution. And its digital control allows you to precisely programme up to 72 hours.



70/0057  
Excalibur EE 10 bandejas  
Excalibur EE 10 trays

Excalibur EE - 10 bandejas / trays

Motor: 220 V / 50 - 60 Hz

Potencia / Power: 700 W

Bandeja / Tray: 38 x 38 cm

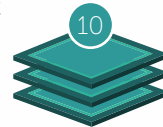

bandejas de malla /  
Mesh trays



Funcionamiento de Excalibur  
Excalibur operation video



**Excalibur**  
AMERICA'S BEST DEHYDRATOR  
PROFESSIONAL SERIES



Instrucciones en  
User manual in:  
EN - SP - FR

70/0001  
Excalibur PRO EXC10EL

230 V / 50 Hz  
Ventilador: 18 cm / 600 W  
Sup. secado: 1,4 m<sup>2</sup>  
Bandeja: 38 x 38 cm  
Fan: 18 cm / 600 W  
Drying sur.: 1,4 m<sup>2</sup>  
Tray: 38 x 38 cm

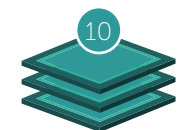

bandejas / trays  
Parallexx® Drying System



**EXTREME PRECISION  
DIGITAL CONTROLLER**  
2 ciclos de tiempo con diferentes temperaturas  
2 zones 2 times/2 temperatures 99 hour timer

Bandejas de acero inoxidable  
Stainless steel trays





Compatible con Plantillas Krokanters  
Use with Krokanters Stencil



Para serie / Fits series:  
4900 & 4926T

**70/0010**  
Bandeja soporte (recambio)  
Support tray (spare part)

**70/0011**  
Rejilla (recambio)  
Net tray (spare part)

**70/0051**  
Hoja de silicona pura  
Silicone sheet

**70/0039**  
Hoja de teflón antiadherente  
Non-stick Teflon Sheet

Medidas / Measurements 35,5 x 35,5 cm

5 uds  
pcs

5 uds  
pcs

**Conserve:**

- Liofilizados
- Trabajos de azúcar
- Aditivos
- Deshidratados
- Crujientes

**Preserve:**

- Lyophilized food
- Sugar crafts
- Additives
- Dehydrated ingredients
- Crispy and crunchy

Consiga un bajísimo grado de humedad ambiental para una mejor conservación del producto.

Designed to achieve an extremely low degree of relative humidity for a better conservation of the product.



**70/0041**  
Dry Food Box

31 L

50 x 40 cm  
Altura / Height: 27 cm

**Dry Food Box**

Contenedor plástico hermético apilable con deshumidificador eléctrico a 12V. Bajísimo consumo. Regulable en 4 diferentes grados de humedad relativa 55 / 45 / 35 / 25%.

Stackable hermetic plastic container equipped with a 12V electric dehumidifier extremely. Low consumption. Adjustable to 4 different levels of relative humidity 55 / 45 / 35 / 25%.





## Elaboraciones de texturas de hielo

### Ice textures elaborations

Ice Chef es una herramienta versátil e innovadora diseñada para transformar casi cualquier líquido en hielo aromático con texturas únicas.

Inspirado en el Kakigori japonés, permite congelar al instante líquidos con distintas composiciones como agua, grasas o alcoholes, y raspar el hielo en láminas, copos, virutas o abanicos.

Ice Chef abre nuevas posibilidades en postres, coctelería y cocina técnica, aportando precisión, creatividad y un resultado visualmente impactante.

Ice Chef is a pioneering device engineered to freeze virtually any liquid into aromatic ice forms with unique textures.

Its mission is to elevate culinary creativity by instantly producing ice with novel textural profiles. Inspired by methods like Japanese *Kakigori*, it instantly freezes liquids of diverse compositions—including water, fats, or alcohols—and shaves the ice into thin sheets, flakes, curls or fans.

This opens a whole new realm of possibilities across mixology, desserts, and avant-garde cuisine

30/0131

Ice Chef

220 V

31 x 57 x 42 cm

Tamaño del rodillo /

Roller size Ø 9 cm



De líquido a hielo  
From liquid to ice

YouCook





## CARACTERÍSTICAS DESTACADAS

- **Versatilidad de ingredientes:** trabaja con una amplia gama de líquidos, desde zumos y cócteles a salsas y productos grasos como el chocolate.
- **Diferentes formas y texturas con una única herramienta:** con si ajuste de velocidad y distancia de la cuchilla.
- **Innovación en congelación:** al trabajar con una temperatura de  $-35^{\circ}\text{C}$ , asegura una congelación inmediata.
- **Producción silenciosa:** con una capacidad de 5 kg/h, ofrece un rendimiento excepcional sin hacer ruido.
- **Diseño atractivo:** ideal para *show cooking*, buffets o coctelerías entre otros. Genera experiencias visualmente impactantes.

## KEY FEATURES:

- **Versatile ingredients:** works with a wide range of liquids, including juices, cocktails, sauces and fatty products such as chocolate.
- **Different shapes and textures can be achieved** using a single tool with adjustable speed and blade distance.
- **Innovative freezing:** works at a temperature of  $-35^{\circ}\text{C}$  to ensure immediate freezing.
- **It offers exceptional performance** without making noise, with a capacity of 5 kg/h.
- **Attractive design:** ideal for show cooking, buffets, cocktail bars and more. It creates visually stunning experiences.



Guía culinaria Ice chef  
Ice chef culinary guide





## Mantecedora profesional Professional ice cream maker

Obtenga helados cremosos, suaves, ligeros y homogéneos en tan sólo 10 minutos.

Ice Lab ofrece un proceso de elaboración controlado, manejo sencillo y de escaso mantenimiento. Una máquina robusta de reducidas dimensiones que le permitirá elaborar un helado de gran calidad sin necesidad de disponer de grandes conocimientos.

Get creamy, smooth, light, and homogeneous ice creams in just 10 minutes with Ice Lab.

It offers a controlled production process, easy handling, and low maintenance. This robust machine, despite its compact size, allows you to create high-quality ice cream without requiring extensive knowledge.

## Ice Lab para cada necesidad Ice Lab for every need

Ref.	Modelo / Model	Capacidad / Capacity	Medidas / Measures
30/3013	H-1	0,25 / 0,50 L	30 x 45 x 45,5 cm
30/3015	H-2	0,7 / 1,4 L	35 x 50 x 57 cm
30/3016	H-4	1,2 / 2,5 L	40 x 64 x 62 cm
30/3017	H-6	2 / 4 L	42 x 60 x 70 cm
30/3018	H-10	3 / 6,5 L	42 x 60 x 70 cm



- > Hogar  
Home
- > Restaurante - Lab  
Restaurant - Lab
- > Restaurante - Hotel  
Restaurant - Hotel
- > Hotel  
Hotel
- > Heladería /  
Ice-cream shop

Cilindro en acero inoxidable con enfriamiento de expansión directa.

Stainless steel cylinder with direct expansion cooling.

Agitadores que maximizan el volumen del helado (OVERRUN).

Agitators that maximize ice cream volume (OVERRUN).

Funciones de extracción y limpieza automática.

Extraction and automatic cleaning functions.

Helados cremosos en minutos  
Creamy ice creams in minutes

YouCook



Fabricadas completamente en acero inoxidable para un mayor control térmico y mayor higiene.

Made entirely of stainless steel for enhanced thermal control and increased hygiene.





Conchadora basculante de sobremesa

Por fin una cochadora compacta y versátil que trabaja hasta 3 kg de producto a la vez.

Twin Stones es ideal para preparaciones tanto dulces como saladas, generando texturas y emulsiones perfectas e impalpables.

Ahora incorpora tracción con engranajes dentados, que aportan mayor resistencia y fuerza a la correa, mejorando el rendimiento, consiguiendo reducir el tiempo de refinado evitando sobrecalentarlos, mientras que el doble deflector dirige el fluido bajo las piedras para una mejor aireación o conchado. Además, el bol es inclinable, lo que facilita la retirada del producto.

¡Ahora con un nuevo sistema de sujeción! podrás retirar los rodillos con facilidad para una mejor limpieza.



Table Top Wet Grinder

Finally, a compact and versatile roller mill with a processing capacity of up to 3 kg per batch.

The Twin Stones model is ideal for both sweet and savoury preparations, creating perfect, impalpable textures and emulsions.

It now incorporates toothed gear traction, which provides the belt with greater resistance and strength, improving performance and reducing refining time while preventing overheating. The double deflector also directs the fluid under the stones for better aeration or conching. The bowl is also tiltable for easier product removal.

Now with a new fastening system! You can easily remove the rollers for better cleaning.



Primeros pasos  
First steps

YouCook

TWIN STONES

30/0053  
230V · 50Hz

30/0054  
110V · 60Hz

Ø base 35 cm

Altura / Height: 40 cm

**130 RPM** | motor de alto rendimiento  
high performance motor



2 piedras de granito actúan como un molino...  
¡para crear emulsiones y texturas perfectas!

2 granite stones act like a mill...  
to create perfect emulsions and textures!



Moler / Grind



Amasar / Knead



Rallar / Grate



Emulsionar / Emulsify

## bean-to-bar taste-to-bar

Gran capacidad  
Big Capacity

**3Kg** con producto cremoso o líquido  
with creamy or liquid products

**2Kg** con producto espeso  
with thick products

Ø 25 cm

Bol en inox con base en granito  
Stainless steel drum with granite base



30/0086

Soporte INOX Twin Stones  
Twin Stones Stainless Steel Support

Soporte de acero inoxidable que aumenta la presión del conchado, acelera el proceso y evita el calentamiento del producto.  
Saque el máximo rendimiento con este accesorio.

Stainless steel support that increases the conching pressure, speeds up the process and prevents the product from heating up.  
Get the most out with this accessory.



**Premier®**

*Chocolate Refiner*

21,5cm

36 cm



15 cm



Nuevo sistema con palometas para facilitar su limpieza

New system with palettes to facilitate cleaning

## REFINADORA DE CHOCOLATE PREMIER SS

Premier SS combina potencia y precisión en un formato compacto, ideal para artesanos y profesionales del chocolate.

Su sistema de rodillos de granito y espátulas laterales garantiza un **refinado uniforme** y una textura perfectamente lisa y aireada, acelerando el conchado y mejorando el sabor final del producto.

Gracias a su funcionamiento a baja temperatura, **conserva intactos los nutrientes y aromas naturales** del cacao y los frutos secos.

El motor, diseñado para trabajo continuo, ofrece un rendimiento estable incluso en producciones prolongadas. Su diseño robusto y fácil de limpiar la convierte en una herramienta indispensable para quienes buscan calidad, consistencia y resultados profesionales en cada lote.

## PREMIER SS CHOCOLATE REFINER

Premier SS is the perfect combination of power and precision in a compact format, making it ideal for artisans and chocolate professionals.

Its granite roller system and side spatulas ensure **uniform refining** for a perfectly smooth, aerated texture, speeding up the conching process and enhancing the final flavour of the product.

Thanks to its low-temperature operation, the **natural nutrients and aromas of the cocoa and nuts are preserved intact**.

The motor is designed for continuous operation and offers stable performance, even during prolonged production runs. Its robust, easy-to-clean design makes it an essential tool for achieving consistent, professional results in every batch.

30/0094

Refinadora de chocolate  
Chocolate refiner

220 V / 50-60 Hz / 200 W

**¡ELABORA CHOCOLATE Y PASTAS PURAS DE FRUTOS SECOS DESDE CERO!**

**MAKE CHOCOLATE AND NUT BUTTERS FROM SCRATCH!**

Cold  
Refiner



Pon a punto tu Premier  
Setup your Premier

YouCook



Bean to bar

YouCook



120 - 140 RPM  
CAPACIDAD / CAPACITY 3,5 KG

REFINA A MENOS DE 20  $\mu$ m  
REFINE TO LESS THAN 20  $\mu$ m

SISTEMA DE REFRIGERACIÓN SUPERIOR  
72 h de funcionamiento seguro.  
SUPERIOR COOLING SYSTEM  
72 h continuous operation.

INCLUYE VASO MEDIDOR Y ESPÁTULA  
INCLUDES MEASURING CUP AND SPATULA

FÁCIL DESMONTAJE Y LIMPIEZA  
EASY DISASSEMBLY AND CLEANING

RODAMIENTOS SELLADOS Y RESISTENTES  
Evitan el sobrecalentamiento del motor.  
SEALED AND DURABLE BEARINGS  
Prevent the engine from overheating.





## REFINADORA PROFESIONAL DCM 15 DCM 15 PROFESSIONAL REFINER

Con una capacidad de hasta 7 kg por lote, está diseñada para artesanos y productores *gourmet* que buscan llevar su marca al siguiente nivel. Es ideal para elaborar chocolate *bean-to-bar*, cremas de frutos secos, pralinés, untables, y bases para helados y *gelatos*, esta máquina ofrece un rendimiento de nivel profesional en un formato compacto y silencioso.

With a batch capacity of up to 7 kg, this machine is ideal for artisan and gourmet producers looking to expand their business. This machine is ideal for making *bean-to-bar* chocolate, nut creams, pralines, spreads and ice cream and *gelato* bases, and offers professional-level performance in a compact and silent format.



**REFINADO DELICADO Y SABOR SUPERIOR**  
Preserva el valor nutricional y refina las partículas a 20 µm, logrando una textura perfectamente lisa.

**DELICATE REFINEMENT AND SUPERIOR FLAVOUR**  
Preserves nutritional value and refines particles to 20 µm, achieving a perfectly smooth texture.

**SISTEMA RECLINABLE**  
Permite una extracción y limpieza rápida y práctica.

**RECLINABLE SYSTEM**  
Enables quick and easy extraction and cleaning.

**MÁXIMA DURABILIDAD Y EFICIENCIA ENERGÉTICA**  
Motor de alta eficiencia y bajo consumo diseñado para trabajar 24 horas al día, 360 días al año.

**MAXIMUM DURABILITY AND ENERGY EFFICIENCY**  
High-efficiency, low-consumption motor designed to operate 24 hours a day, 360 days a year.

30/0500  
Refinadora profesional DCM 15  
DCM 15 professional refiner

220 V  
Motor: 186.5 W (1/4 HP)  
33 x 30 x 55 cm



30/0501

DCM Breeze winnower mini

220 V  
Motor: 100 W  
40 x 40 x 81 cm



## DCM BREEZE WINNOWER MINI

Descascarillador-aventador de sobremesa, diseñado especialmente para chocolateros y productores artesanales. Compacto y eficiente, permite **procesar granos de cacao** de manera profesional y fácil, gracias a su compatibilidad con aspiradores domésticos.

This tabletop shelling and winnowing machine is specially designed for chocolatiers and artisan producers. It is compact, efficient, quiet, and allows for the professional and easy processing of cocoa beans thanks to its compatibility with domestic vacuum cleaners.

### Características clave:

Key features:

#### Eficiente Efficient

Más del 90% de separación efectiva de nibs y cáscaras sin necesidad de reprocesar.

Over 90% effective separation of nibs and shells without the need for reprocessing.

#### Versátil Versatile

Funciona con granos crudos y tostados, de diferentes formas y tamaños

Works with raw and roasted beans of different shapes and sizes.

#### Rápido y productivo Fast and productive

Procesa de 10 a 15 kg de granos de cacao por hora.

Processes 10 to 15 kg of cocoa beans per hour.

#### Fácil y limpio Easy and clean

Funcionamiento manos libres, libre de polvo y con menos fragmentos de cáscara en los nibs.

Hands-free operation, dust-free, and fewer shell fragments in the nibs.

\* ASPIRADOR NO INCLUIDO / VACUUM IS NOT INCLUDED





## Pequeño bombo confitero Little coating pan

Para recubrir sin esfuerzo todo tipo de piezas con chocolate y garrapiñar los frutos secos o cereales con azúcar. Adaptable a cualquier modelo de robot Kitchen Aid o Kenwood.

For coating all sorts of nuts, truffles, and confections with tempered chocolate, sugar and other coatings. Also great for sugar coating almonds, dried fruits, cereals, turning them into succulent dragees. Fits any model of Kenwood or Kitchen-Aid stand mixers.



Snack cover

YouCook



3 Kg

Rampa incluida  
Ramp included

50/0002  
Confi-Kit Kitchen Aid

► Diseñado para todas las batidoras Kitchen Aid  
Designed to fit all Kitchen Aid stand mixers



50/0003  
Confi-Kit Kenwood NEW

► Diseñado para el nuevo modelo de Kenwood  
Designed to fit the last Kenwood model



50/0053  
Confi-Kit Kenwood OLD

► Diseñado para los antiguos modelos Kenwood  
Designed to fit the old Kenwood model



- Gelatinas • Garrapiñados saborizados • Crackins con Snack Cover • Frutos secos recapados • Grageas con chocolate saborizado • Frutas & vegetales recapados •
- Gelly Candies • Sugar-Coated Pills • Savoury Snacks • Coated Dried Fruit • Flavour-Coated Chocolates • Coated Fruits & Vegetables •





Máquina profesional para algodón de azúcar  
Cotton Candy professional machine

**SUPER SNACK COTTON** es la máquina profesional de altas prestaciones. Una producción rápida y constante de algodón de azúcar blanco, con la posibilidad de añadir saborizantes y colorantes. Pensada para el uso comercial y larga duración. Fácil mantenimiento y limpieza.  
Heavy-duty professional machine to produce high volumes of cotton candy. Add extra flavor and color in a rapid and steady production. Easy cleaning and maintenance.



Aprende más  
Learn more



Bol de acero inoxidable  
Cabezal giratorio macizo auto nivelable  
Stainless Steel Bowl  
Solid, auto-leveling spinning head



40/0011  
Cúpula transparente Super Cotton  
Super Cotton Clear Dome



Ø 50 cm



Ø 5, 7, 10, 13 cm

40/0012  
Molde empanadilla (4 tamaños)  
Dumpling Maker (4 sizes)



Empanadilla de frambuesas  
Raspberry small pasty



40/0010  
Super Cotton Candy Machine

230 V
50 Hz
1000W

40/1010  
Super Cotton Candy Machine [USA plugin]

110 V
60 Hz
1000W

## Turning-Kit®

### Espirales y muelles Spirals and springs

La herramienta perfecta para crear diferentes formas y tamaños de muelle, con caramelo, chocolate u otras elaboraciones.

A perfect tool for creating different spiral shapes with caramel, chocolate or other preparations.

50/0004

Turning-Kit

El kit incluye / Kit includes  
Cilindro / Cylinder: Ø 4 cm  
Cilindro / Cylinder: Ø 1,5 cm  
Cono / Cone: de / from Ø 1 a / to Ø 4 cm  
Llave Allen / Hex Key  
Puntas de sujeción de azúcar /  
Sugar start support  
Eje giratorio intercambiable /  
Interchangeable rotating axis

\* No se incluye el destornillador eléctrico  
\* This model does not include electric screwdriver.

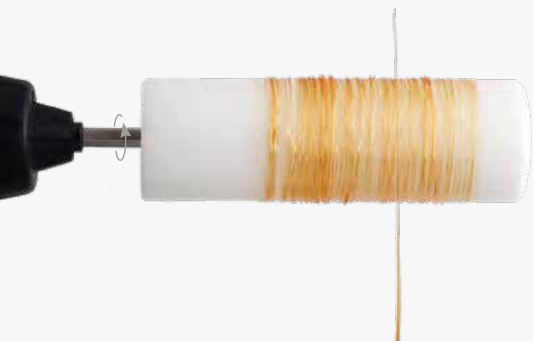

Da forma a tus azúcares  
Shape your sugars

YouCook

## DekoSpray

Handheld airbrush

Aerógrafo manual de fácil funcionamiento, con baterías recargables. De gran precisión para decorar moldes o piezas pequeñas y pistolear sobre platos o vasos. Es perfecto para decoración con Stencils.

Easy-to-use handheld airbrush with rechargeable batteries. It offers great precision for decorating molds or small pieces and spraying on plates or glasses. It is perfect for stencil decoration.

\*Autonomía de 30 minutos de trabajo continuo  
30 minutes of continuous work autonomy

30/0095

DekoSpray

Incluye 2 depósitos (15 y 30 ml)

Includes 2 tanks (15 and 30 ml)



30/0096

DKS container

Repuesto / Replacement



**DJ**  
Decor Food  
TURNTABLE

Soporte giratorio automático y regulable para decorar platos, pasteles, tartas, bandejas, vasitos y copas utilizando lápices alimentarios, brochas, salsas en botellines, mangas pasteleras. Perfecto para pintura de chocolate o aerografía.

Puede cambiar el sentido del giro o utilizarlo de forma manual para trabajos de precisión.

This automatic spinning support offers easy way to decorate plates, cakes, tarts, trays, glasses and shots, by using food markers, brushes, bottled sauces, pastry bags. Perfect for painting with chocolate and airbrushing. It is possible to change spin direction or use it manually for works requiring more precision.

UP TO  8 Kg  
↓

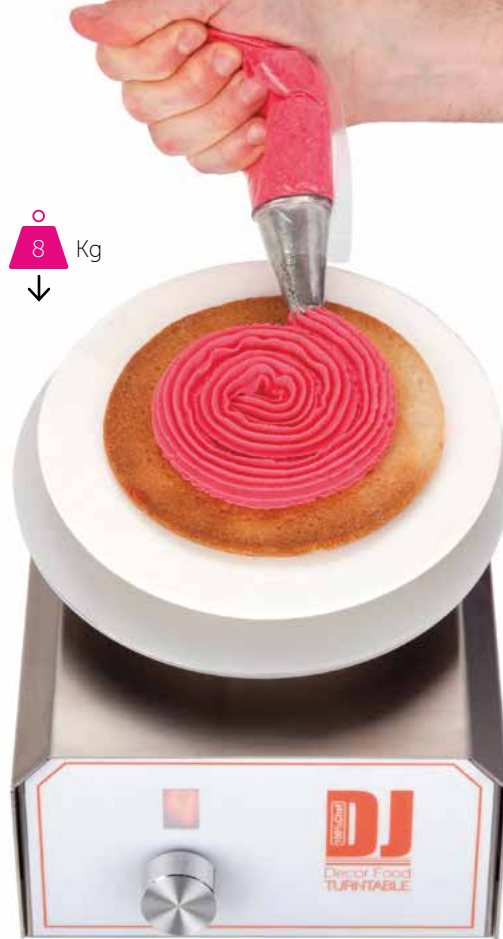

500/0051  
DJ Decor Food TurnTable

MODELO COMPATIBLE	230 V / 50 Hz
COMPATIBLE MODEL	110 V / 60 Hz



De 3 a 60 RPM  
From 3 to 60 RPM

## Magic Drop

Spray efecto mercurio  
Mercury effect spray

Aumenta la tensión superficial del plato impidiendo que los líquidos se esparzan, consiguiendo emplatados imposibles con salsas, coulis, jugos, aceites...

This spray increases the surface tension of the plate, preventing the liquids from spreading on it. So you can obtain impossible platings with sauces, coulis, juices, oils.



210/0053  
Magic Drop Spray 250 gr

Recomendado para platos esmaltados, porcelana, cerámicas y cristal  
Recommended for enameled plates, porcelain, ceramics and glass

Resiste unos 10 lavados  
Resists up to 10 washes



## TROLLEYS

Explore nuestra exclusiva línea de carros de servicio, diseñados meticulosamente para brindar experiencias y espectáculo frente al cliente.

Explore our exceptional range of service carts, meticulously crafted to deliver unforgettable experiences and captivating performances to your valued customers.

Fabricados en Solid Surface presentan:

- **Máxima Dureza**
- **Resistencia a la abrasión, no amarillean**
- **Impermeables y de fácil limpieza**

Manufactured in Solid Surface they have:

- **Maximum hardness**
- **Abrasion resistance, no yellowing**
- **Waterproof and easy to clean.**

Personalice su Trolley con logo, iluminación y colores corporativos.

Customize your Trolley with your logo, customized lighting, and corporate colors.

100/0402  
Trolley Gin&Tonic\*

26 x 60 cm  
Alt / Height: 105 cm



- Enfriador de copas -85°C integrado con CO<sup>2</sup>
- Cubitera
- Especiero
- Espacio para residuos
- 
- Glass cooler -85°C integrated with CO<sup>2</sup>
- Ice bucket
- Spice tray
- Waste disposal area



- Capacidad para:
- 8 copas
- 6 botellas
- 8 tónicas
- 
- Capacity for:
- 8 glasses
- 6 Gin bottles
- 8 Tonic water



- Luces led de distintos colores
- Mando a distancia
- Batería propia
- 
- LED lights of different colors
- Remote control
- Own battery

\*No incluye grifería ni botella CO<sup>2</sup>.

\*Faucets and CO<sup>2</sup> cylinder are not included.

100/0401

Trolley Jabugo Premium

26 x 60 cm

Alt / Height: 85 cm

Multiposición orbital  
Orbital Multiposition

Rotatorio 360°  
360° Rotary

Deposito residuos  
Waste deposit

Bandeja extraíble  
Pull-out tray

Gran espacio de almacenaje  
Large storage space



## El Trolley multifuncional The multi-functional trolley

100/0403

Trolley Gueridon

26 x 60 cm

Alt / Height: 105 cm

- Bandeja extraíble
- Pull-out tray



- Gran espacio de almacenaje
- Large storage space



Maniobrabilidad  
Maneuverability

Personalice su Trolley con logo, iluminación y colores corporativos.

Customize your Trolley with your logo, customized lighting, and corporate colors.

*"La esferificación fue patentada en 1942 por el tecnólogo de alimentos William J.M. Peschardt, y fue el restaurante ElBulli quien, posteriormente, lo popularizó. Desde entonces, esta preparación sorprendente ha estado en constante evolución"*

*"Spherification was patented in 1942 by the food technologist William J.M. Peschardt and popularised by the restaurant El Bulli. Since then, this surprising preparation has been constantly evolving"*







## Esferificaciones más rápidas y precisas Faster and more precise spherifications

Con un diseño optimizado de sus vasos, este kit permite obtener esferas más redondas, uniformes y voluminosas de manera sencilla. Este kit está diseñado para perfeccionar y agilizar la técnica de esferificación inversa, permitiendo que principiantes y chefs profesionales disfruten de una experiencia culinaria de alto nivel sin complicaciones.

With its optimised glass design, this kit allows you to obtain rounder, more uniform and voluminous spherifications effortlessly. This kit is designed to perfect and streamline the reverse spherification technique, allowing beginners and professional chefs to enjoy a high-level culinary experience without complications.

Accede al manual para saber más  
Access the manual to learn more



20/0020  
Sphere Chef Kit



## Pasos / Steps

Con estos sencillos pasos podrá conseguir el resultado deseado.

With this easy steps you can get the desired result.

FÁCIL  
EASY



Preparación de los ingredientes  
Ingredient preparation

**YouCook**

1



Llenar la base con una capa de alginato hasta la primera línea

Fill with alginate up to the first line

3



Rellenar el vaso con alginato realizando movimientos circulares

Fill the glass with alginate with circular motion

5

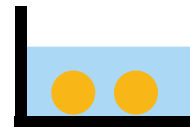

Retirar del baño de alginato y limpiar en un baño de agua

Remove from the alginate bath and clean in a water bath

2



Introducir la mezcla del producto que se desee esferificar

Add the mixture of the product to be spherified

4

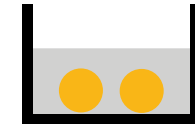

Colocar las esferas en un baño de alginato

Place the sphere in an alginate bath

6



Sacar la esfera y secarla con la ayuda de un paño bajo la cuchara

Scoop the sphere and dry it with a cloth under the spoon

## ¿Qué incluye el kit?

What's included in the kit?

1 dosificador  
16 vasos en 4 tamaños  
2 biberones para alginato (400 ml)  
1 cuchara Lotus Round  
1 cuchara Lotus Oval  
Muestras de Algi, Gluc y Xtan

1 dispenser  
16 glasses in 4 sizes  
2 bottles for alginate (400 ml)  
1 Lotus Round spoon  
1 Lotus Oval spoon  
Algi, Gluc & Xtan samples

20/0020  
Sphere Chef Kit

20/0018  
Sphere Kit 16 vasos  
Sphere Kit 16 glasses

Guía Sphere Chef Kit  
Sphere Chef Kit Guide

YouCook

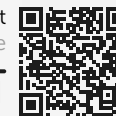

20/0019  
Sphere dosificador  
Sphere dispenser

Dispensador de líquido  
con pistón  
Liquid dispenser with piston



40404000	Xtan
40407000	Algi
40407004	Gluc



XL: Ø 5 cm    L: Ø 4 cm    M: Ø 3 cm    S: Ø 2 cm



20/0004  
Cuchara Lotus  
Lotus Spoon

10 uds  
pcs

Esferificación con colorante oro  
/ Spherification with golden dye



Esferificación doble color  
/ Double colour spherification



Accede al recetario  
Recipe book acces

PDF ESP

PDF ENG

Esferificación de agua de mar con huevos de salmón  
/ Seawater spherification with salmon roe



Esferificación frita de jamón (falsa croqueta)  
/ Fried ham spherification (fake croquette)

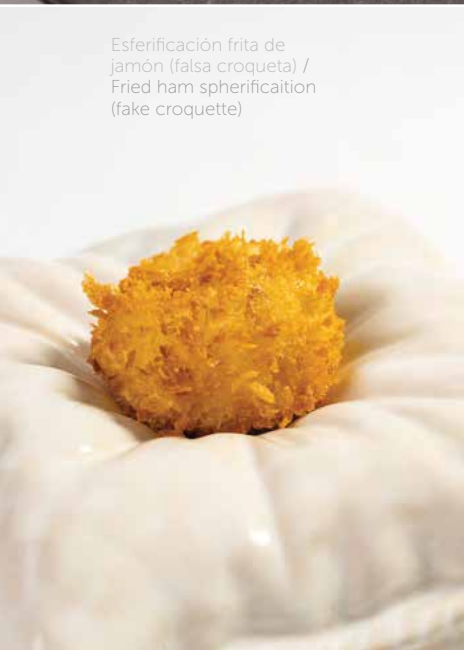

Esferificación de crema catalana  
/ Crème brûlée spherification



Esferificación pasificada  
/ Raisined spherification



# Reverse Sphere®

Hasta 100 esferas por minuto  
Up to 100 spheres for minut

Reverse Sphere® es el dosificador para la esferificación inversa o directa. Elabore sin esfuerzo esferas líquidas con tres diámetros diferentes. Produzca perlas líquidas con mucha antelación sin que endurezcan, para disponer en su *mise en place* de perfectas bombas de sabor sin apenas dedicación.

Reverse Sphere® is the dispenser for reverse or direct spherification. Produce easily liquid spheres in three different diameters. Produce liquid spheres in advance without setting, so you can have perfect flavour bombs at your *mise en place* with little effort.

20/0006

Reverse Sphere Dispenser Kit

El kit incluye cuchara coladora Lotus y 3 boquillas de difrentes diámetros  
Lotus strainer spoon and 3 different sized nozzles are included



Esferificación fácil y rápida  
Easy and quick spherification

YouCook



Contiene recetas en el interior  
Recipes included



3 X

MEDIDAS BOQUILLAS  
NOZZLES MEASURES



6 mm



8 mm



10 mm



INOX  
STAINLESS  
STEEL



20/0004  
Cuchara Lotus  
Lotus Spoon

10 uds  
pcs

14K



20/2004  
Cuchara Lotus GOLD  
GOLD Lotus Spoon

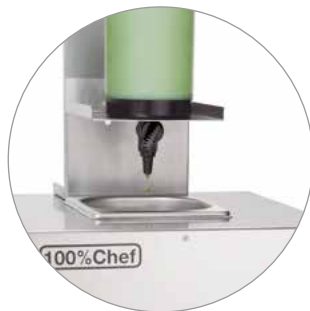

¡Produce 2 Kg/hora!  
Produces up to 2 Kg/hour!



El ventilador interno garantiza  
el máximo rendimiento  
incluso con esferas pequeñas  
The internal fan works even with  
small spheres

¡Único  
en el  
mercado !  
Unique  
in the  
market!

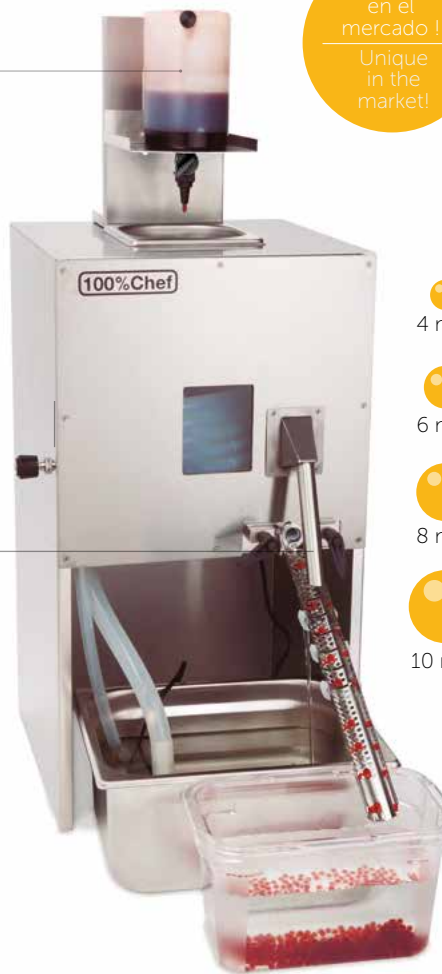

- 4 mm
- 6 mm
- 8 mm
- 10 mm

# Spherificator

Esferas automáticas  
Automatic spheres

Dosifica automáticamente perlas de 4 tamaños distintos, 4, 6, 8 y 10 mm, produciendo **más de 100 esferas por minuto**. Este sistema permite elaborar caviar o perlas líquidas en gran cantidad con antelación, sin que endurezcan. Su sistema básicamente está diseñado para producir la esferificación inversa y poder tener en su *mise en place* una producción con gran rendimiento.

Completely automatic, Spherificator produces more than 100 spheres per minute, in four different diameters (4, 6, 8 and 10 mm). Prepare in advance huge quantity of imitation caviar for parties, corporate events and any sort of catering. Reverse spherification ensures the best yield needed by professionals.

20/0005  
Spherificator

Dimensiones / Size  
36 x 36 x 66 cm



# wonder**bubbles**

Esta innovadora estación de esferificación permite crear perlas con sabores únicos, agregando un toque espectacular a bebidas frías y calientes, helados, platos y postres. Impresiona a tus clientes gracias a un atractivo diseño de sobremesa y su efecto visual hipnótico de goteo.

This innovative spherification station allows you to create pearls with unique flavours, adding a spectacular touch to hot and cold drinks, ice creams, dishes and desserts. Impress your customers with its attractive tabletop design and hypnotic visual drop effect.

30/3023

Wonder Bubbles (110 V / 220 V)

Se incluye / It includes:

- 1 máquina Wonder Bubbles
- 2 vasos
- 2 botellas
- 2 cucharas coladoras Lotus
- 2 imanes
- 3 boquillas (2, 4, 6 mm)
- 1 Wonder Bubbles machine
- 2 glasses
- 2 bottles
- 2 Lotus strainer spoons
- 2 magnets
- 3 nozzles (2, 4, 6 mm)

MEDIDAS BOQUILLAS  
NOZZLES MEASURES



2 mm 4 mm 6 mm





*"Ideal para dar un toque distintivo a tu negocio"*  
*"Ideal to give a distinctive touch to your business"*

## La esencia para crear Burbujas Wonder The essence to create Wonder Bubbles

Diseñada específicamente para nuestra máquina, Wonder Water es la solución de agua con lactato de calcio dosificado, lista para usar y esferificar las gotas de sabor Wonder Potion instantáneamente.

Designed specifically for our machine, Wonder Water is the ready-to-use water solution with dosed calcium lactate to spherify Wonder Potion flavour drops instantly.

30/3024  
Wonder Water

1 L



Conoce más sobre Wonder Bubbles  
Learn more about Wonder Bubbles

YouCook



## Wonder Potion

500 ml

30/3026	Chocolate	30/3045	Trufa blanca / White truffle
30/3028	Caramelo / Caramel	30/3046	Limón / Lemon
30/3029	Menta / Mint	30/3047	Chili
30/3030	Fresa / Strawberry	30/3048	Naranja / Orange
30/3044	Regaliz / Licorice	30/3049	Pimienta negra / Black pepper
		30/3050	Café / Coffee







# Caviar-Box®

Más de 95 esferas por segundo  
More than 95 spheres for second

Caviar Box® es el accesorio ideal para trabajar la técnica de la esferificación: permite elaborar de forma muy rápida, una gran cantidad de bolitas de caviar líquido con mucha precisión. Ideal para alta restauración, banqueting y cocktail.

Caviar Box® is our bestseller to realize the spherification technique. Produce precisely and quickly a large amount of liquid caviar. Designed to fasten the preparation for cocktail bars and catering.

FÁCIL  
EASY

20/0002

Caviar Box desmontable  
Disassemblable Caviar Box



TOTALMENTE DESMONTABLE  
FÁCIL LIMPIEZA

FULLY DISASSEMBLABLE  
EASY TO CLEAN



20/0003

Siliconas de recambio Caviar Box  
Caviar Box silicones replacement

3 uds  
pcs



Cómo usar Caviar Box  
How to use Caviar Box

YouCook

## SpaghettoKit®

Ideal para elaborar 5 Spaghetto de 1 m de una vez  
 Ideal kit for preparing 5 Spaghetto of 1 m at once

30/0001  
 Spaghetto Kit Classic

Guía de uso de Spaghetto Kit  
 Spaghetto Kit guide



YouCook

El kit incluye / Kit includes:

- 01 - 1 biberón de relleno
- 02 - 5 tubos bridados de 1 m
- 03 - 1 adaptador para sifón
- 01 - 1 filler squeeze bottle
- 02 - 5 tubes of 1 m
- 03 - 1 adapter for whipper



## MacarrónKit®

Arpa de acero inoxidable ideal para la elaboración de tubos y cilindros de gelatina. Rápida producción e infinitas posibilidades de utilización.

Perfect tool for creating tubes and cylinders with flavored gelatines. Fast and easy production and many usages applications.

50/0017  
 Macarron Kit XL



FÁCIL  
 EASY



Macarrones gelificados de café  
 Jellified coffee macaronis



YouCook

*"La cocción al vacío a baja temperatura ha permitido a los chefs obtener resultados consistentes y precisos de cualquier ingrediente, dando como resultado sabores y texturas incomparables"*

*"Low temperature vacuum cooking has allowed chefs to obtain consistent and precise results from any ingredient, giving incomparable flavours and textures"*



# VACUUM TECHNOLOGY & ULTRASOUNDS

DESTILACIÓN Y REDUCCIONES / DESTILATION & REDUCTIONS .....	135
---------------------------------------------------------------	-----

Destilación al vacío en cocina y mixología. Más intuitivo, preciso y eficiente  
Vacuum distillation in cooking and mixology made more intuitive, precise and efficient

COCINA AL VACÍO / VACUUM COOKING .....	141
----------------------------------------	-----

Herramientas profesionales para la cocción al vacío a baja temperatura  
Professional tools for vacuum cooking at low temperature

CONSERVACIÓN AL VACÍO / VACUUM STORAGE .....	148
----------------------------------------------	-----

Complementos para el sellado de los alimentos  
Complements for food sealing

# Girovap

distiller-pro2

## Innovación en la destilación profesional Innovation in professional distillation

El nuevo modelo de Girovap Pro2 redefine la destilación al vacío en cocina y mixología gracias a su apuesta por la tecnología, la innovación y el diseño. Este dispositivo de última generación incorpora nuevas funcionalidades que aseguran una experiencia más intuitiva, precisa y eficiente.

El nuevo Girovap no es solo un destilador al vacío, es la herramienta que transforma las cocinas en laboratorios de experimentación culinaria, haciendo más accesible la innovación.

The new Girovap Pro2 model redefines vacuum distillation in cooking and mixology thanks to its commitment to technology, innovation and design. This cutting-edge device incorporates new functionalities that ensure a more intuitive, precise and efficient experience.

The new Girovap is not just a vacuum distiller, it is the tool that transforms kitchens into culinary experimental labs, making innovation closer to hand.

**GIROVAP PRO2**  
Destilador Profesional  
Professional Distiller

30/0150  
230 V

30/0151  
110 V

Largo / Length: 57.5 x 40 cm  
Altura / Height: 38 cm

El manual de usuario incluye explicaciones detalladas y un curso de iniciación sobre los procesos de combinación entre el vacío y la temperatura



The user manual includes detailed explanations and an initiation course to understand the processes of the combination between vacuum and temperature



Pantalla táctil intuitiva que guía al profesional permitiéndole guardar, recuperar y optimizar sus preparaciones  
Intuitive touch screen that facilitates navigation and guides the professional by letting save, retrieve and optimize recipes

Nueva hélice Ninja, con mayor capacidad de arrastre, realiza reducciones extremas con total precisión  
New Ninja helix, with greater drag capacity, performs extreme reductions with total precision

Procesos más precisos, ideal para técnicas avanzadas como concentración, extracción, clarificación y reducción a baja temperatura  
Finer processes, ideal for advanced techniques such as concentration, extraction, clarification and low-temperature reduction

## 🔥 Ventajas y novedades

- Manejo más fácil e intuitivo
- Versátil y modular
- Tapas antipresión que permiten elevar el nivel de vacío
- Sistema de rotación magnético
- Bomba de vacío de membrana
- Producciones de hasta 5 L
- Ultrasilencioso
- Mantenimiento y limpieza simplificados
- Reparación y actualización constante

## 🔥 ¿Qué puedo hacer con Girovap Pro2?

- Infundonar
- Impregnación
- Realización de vacío de otros recipientes
- Cocción a baja temperatura
- Más posibilidades de crear jarabes, extractos, tinturas, impregnaciones, marinados, etc.
- Re-destilaciones alcohólicas con sabores y aromas
- Destilación de hidrolatos y esencias
- Desalcoholización de vinos y licores
- Coulis, confituras y mermeladas sin azúcares añadidos
- Concentración de azúcares naturales de pulpas de fruta
- Reducción de lácteos a leches condensadas
- Reducción de elementos grasos (yema), de vinagres, sojas, tabascos
- Aromatización de ingredientes mediante impregnación (nibs de cacao, granos de café, frutos secos, azúcares, sales,...)

## 🔥 Advantages & novelties

- Easier and more intuitive operation
- Versatile and modular, it adapts to your needs
- Anti-pressure lids that allow the vacuum level to be increased
- Magnetic rotation system
- Vacuum diaphragm pump (high vacuum level)
- Production up to 5 L
- Ultra-silent
- Simplified maintenance and cleaning
- Repairing and constant updating

## 🔥 What can I do with Girovap Pro2?

- Infusinate
- Impregnation
- Vacuum other containers
- Cooking at low temperature
- More possibilities to create syrups, extracts, tinctures, impregnations, marinades, etc.
- Redistillation of alcohol with the addition of flavors
- Distillation of hydrolates and essences
- Dealcoholisation of wines and liquors
- Coulis, confitures and jams without added sugars
- Concentration of natural sugars from fruit pulps
- Reduction of dairy to condensed milks
- Reduction of fatty elements, vinegars, soybeans, tabascos...
- Aromatisation of ingredients by impregnation (cocoa nibs, coffee beans, nuts...)

¿Qué hace tan especial a Girovap Pro2?  
What makes Girovap Pro2 so special?

YouCook





## Vinos desalcoholizados De-alcoholized wine

Girovap permite **rebajar el grado alcohólico** de cualquier vino o bebida alcohólica de su carta sin perder sus propiedades organolépticas en apenas 20 minutos.

Girovap allows to **decrease the alcohol content** of any wine or alcoholic drink of your menu without, without losing any of its organoleptic characteristics, in just 20 minutes.

## Coctelería Mixology

La destilación abre **nuevos caminos en la coctelería** en la creación de bitters y tinturas, en la utilización de los hidrolatos en la producción a escala, o para perfumar hielos o combinados con matices de autor... y muchas más técnicas posibles.

Distillation opens **new paths in the cocktail industry** to create bitters and tinctures, to use floral waters in scale production, or to perfume ices or cocktails with signature nuances... and many more possible techniques.



Girovap y Desalcoholización  
Girovap & Dealcoholisation



Sake  
Sake

Cerveza  
Beer

Vino tinto  
Red wine

Vino dulce  
Sweet wine

Vino blanco  
White wine

Jerez  
Sherry

Vermouth  
Vermouth

Bitter  
Bitter

Espirituales  
Spirituals



Bloody Mary marino clarificado  
Clarified marine Bloody Mary



Negroni de romero clarificado  
Clarified rosemary Negroni

Espárrago blanco con saúco y macadamia  
White asparagus with elderberry and macadamia  
By Disfrutar Restaurant



## Cocina

### DESTILAR:

Lo importante es el producto resultante del proceso: un líquido con apariencia de agua (alcohol, vinagre o agua) totalmente transparente y con un **sabor y un aroma marcado**.

### CONCENTRAR:

*"El camino mas interesante para los chefs", se pueden obtener elaboraciones ultra concentradas: reduciendo el agua de los productos: obteniendo **texturas de coulis** o **confituras sin azúcares** añadidos para base de sorbetes; **productos grasos concentrados** (cremas dobles, natas con un alto % MG, leches condensadas de cualquier leche animal o vegetal, pomada de yema de huevo) **caldos, jugos y reducciones sin temperatura** (salsas colagenosas, demi glaces, etc.); **reducciones de vinagres** hasta conseguir salsas cremosas con un potencial inexplicable.*

Además podemos **impregnar ingredientes** con presión y cocción a baja temperatura (tales como frutos secos, granos, sales, etc.) para posteriormente obtener elaboraciones con un carácter único (chocolates y pralinés estables de alcohol, etc.).

¡Aplique las técnicas de perfumería en sus recetas y cócteles!

Apply perfume-making techniques to yours recipes ans cocktails!

## Cooking

### DISTILLING:

The important thing is the product resulting from the process: a liquid with the appearance of water (alcohol, vinegar or water) totally transparent and with a **marked flavor and aroma**.

### CONCENTRATING:

*"The most interesting way for chefs", ultra-concentrated elaborations can be obtained by reducing the water of the products: getting coulis textures or jams without added sugars for sorbet base; **concentrated fatty products** (double creams, creams with a high % Fat, condensed milks of any animal or vegetable milk, egg yolk pomade) **broths, juices and reductions without temperature** (collagenous sauces, demi glaces,...); **vinegar reductions** to obtain creamy sauces with an inexplicable potential.*

We can also impregnate ingredients with pressure and low temperature cooking (such as nuts, grains, salts,...) to subsequently obtain elaborations with a unique character (alcohol stable chocolates and pralines,...).

Recetas con Girovap Pro2  
Girovap Pro2 recipes

YouCook



# Girovap

Accesorios originales  
Original accessories



80/0025  
Conexión Girovap vacío externo  
Girovap external Vacuum Connection



30/0102  
Hoja teflón Girovap  
Girovap teflon sheet

2 uds  
pcs



30/0078  
Juntas vaso Girovap  
Joints Girovap Vessel

2 uds  
pcs



30/0079  
Juntas VA032 chupón Girovap  
Vacuum VA032 connection joints

3 uds  
pcs



30/0076  
Frasco y gotero de cristal graduado (10 uds)  
Bottle and graduated glass drippers (10 pcs)

120 ml



30/0052  
Alcoholímetro con probeta  
Alcoholimeter with test tube

100 ml

30/0051  
Decantador Kit  
Decanter Kit

500 ml

Incluye: decantador, pinza de sujeción y pie  
Includes: decanter, clamp and foot



VASO RECOLECTOR 1,5 L  
COLLECTOR GLASS 1,5 L

Vaso recolector de esencias resultantes de la destilación al vacío.

Collection glass for essences resulting from vacuum distillation.

30/0071

Vaso recolector 1,5 L  
Collector glass 1,5 L

1,5 L



3 L

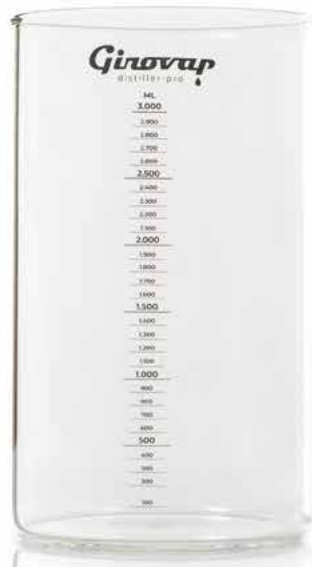

5 L

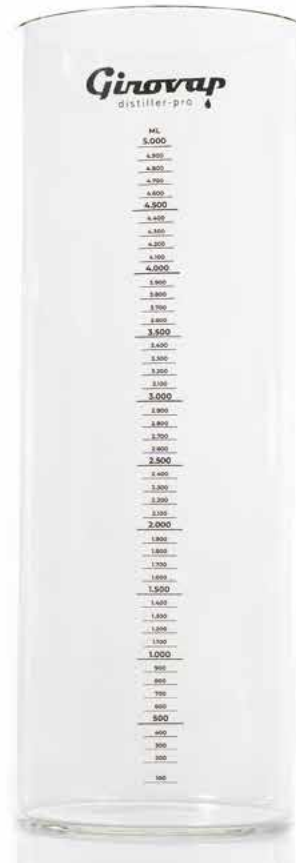

Vasos matraz Girovap  
Girovap flask glasses

Ø15 cm

30/0070 3 L

30/0081 5 L

30/0159

Hélice Ninja para Girovap Pro2  
Ninja propeller for Girovap Pro2



Despiece de Girovap Pro2  
Exploded view of Girovap Pro2

YouCook



# NOON®

FORCE & CLASSIC

80/1058  
Noon Force - 2250 W - 230 V

80/0058  
Noon Classic - 1800 W - 230 V

80/0059  
Noon Classic - 1400 W - 110 V



2250W

Noon es la herramienta profesional definitiva para cocer con precisión alimentos envasados al vacío, infusionar, pasteurizar alimentos previamente cocinados o regenerar cualquier tipo de producto con total seguridad y comodidad, además de realizar cocciones programadas con un alto nivel de precisión. Esta referencia ya clásica de nuestro catálogo ha sido revisado y mejorado aumentando con ello su eficiencia productiva.

Noon is the ultimate professional tool to accurately cook vacuum-packed foods, infuse, pasteurize previously cooked foods or regenerate any type of product with total safety and convenience. The Noon Immersion Circulator guarantees safe and easy programmed cooking with precise time and temperature control. Already a classic in our catalogue, it has been redesigned and improved to increase production efficiency.

## ¿QUÉ NOON ESCOGER? HOW TO PICK YOUR NOON?

NOON FORCE		NOON CLASSIC
54 L	100°C	27 L
65 L	80°C	35 L
75 L	70°C	45 L
100 L	60°C	54 L

1800W

\* Temperaturas medidas en cubetas isotérmicas Noon \*  
\* Temperatures measured in isothermal containers Noon \*



Control de parámetros en 10 idiomas  
Controllers in 10 languages

Presión de la bomba  
Pump pressure 115 Mbar

Caudal de agua  
Water flow 6 L / min



Dos ventiladores  
Two fans



Control presión de agua  
Water control pressure

Tubo conexión bomba de agua  
Water pump connecting pipe

Estabilidad térmica en recipientes profundos  
y precisión de temperatura de 0.1°C  
Thermal stability in deep containers  
and temperature accuracy 0.1°C



Conoce Noon en detalle  
Discover Noon

**YouCook**



# noon<sup>®</sup> compact

Cocción precisa, potente y sin complicaciones  
Precise, powerful and uncomplicated cooking

Diseñado para profesionales exigentes, el nuevo Sous Vide compacto de 27 litros combina potencia, precisión y practicidad en un formato portátil, robusto y ultra silencioso.

Designed for demanding professionals, the new 27-liter compact Sous Vide combines power, precision and practicality in a portable, robust and ultra-quiet format.

30/0130

Noon Compact Vesta 220 V

66 x 54 x 73 cm  
27 L



1800W

Sistema de recirculación de temperatura  
y resistencia interna aislada del agua

Temperature recirculation system  
& internal resistance isolated from water

Asas ergonómicas para un  
transporte fácil y seguro  
Ergonomic handles for easy  
and safe transport



Soporte interior para sujeción  
de varias bolsas

Inner support for holding bags



Tapa para evitar la evaporación  
Lid to prevent evaporation

Pantalla digital intuitiva que permite un control total del tiempo (temporización de hasta 99 horas) y temperatura (con precisión de  $\pm 0,1$  °C), con alertas integradas  
Intuitive digital screen that allows full control of time (timer up to 99 hours) and temperature (accurate to  $\pm 0.1$ °C), with integrated alerts

# noonie

EL MÁS GRANDE ENTRE LOS PEQUEÑOS  
THE BIGGEST AMONG THE SMALL

## Circuladora a baja temperatura semi-pro Semi-pro temperature circulator

Noonie utiliza la tecnología más avanzada en circuladores del mercado. Con una precisión de 0,1°C, incluso a temperaturas inferiores a 50°C, este circulador garantiza **resultados precisos y consistentes en cada preparación.**

Su versatilidad destaca al poder ser acoplado en una amplia variedad de recipientes, adaptándose a sus necesidades. Además, su potencia de 1300W permite calentar baños de hasta 15 litros en cuestión de minutos. Perfecto para producciones de menor volumen, regeneraciones, desayunos, buffets, sifones, salsas ¡y mucho más!

Noonie utilizes the most advanced technology in circulators available in the market. With a precision of 0.1°C, even at temperatures below 50°C, this circulator guarantees **precise and consistent results in every preparation.** Its versatility stands out as it can be easily attached to a wide variety of containers, adapting to your needs. Additionally, its power of 1300W allows for heating baths of up to 15 liters within minutes. Perfect for smaller volume productions, regenerations, breakfasts, buffets, siphons, sauces, and much more!



¿Cómo funciona Noonie?  
How Noonie works?

**YouCook**

4 modos de cocción  
4 cooking modes

Temporizador hasta 99 h  
Timer up to 99 h



Pinza sujeción universal  
Universal clamping pliers

Para baños de 6 - 15 L  
For baths of 6 - 15 L

Alarma por bajo nivel de agua  
Low water level alarm

Precisión temperatura +/- 0,1 °C  
Temperature accuracy +/- 0,1 °C

Temperatura máxima 90 °C  
Max. temperature 90 °C



80/0096  
Noonie

220 - 240 V  
50 - 60 Hz

1300W

# NOON® COMPLEMENTOS ACCESSORIES



80/0055  
Sujetasifón y botellín regulable  
Adjustable whip clip

80/0051  
Cinta adhesiva rotulable  
Writable tape

Largo / Length: 55 m  
Ancho / Wide: 2 cm



6 colores  
6 colors



El mejor sistema para el marcaje de bolsas de vacío, barquetas y todo tipo de recipientes. Puede emplearse en hornos de vapor, baños, congelador, nevera, o estufas calentaplatos. Al despegar no deja residuos.

Label vacuum bags or any food container with this water resistant writable tape. It can be used with any kind of container. Use it in steam oven, immersion circulator, freezer, refrigerator, hot plates or stove. No trace of glue.

Los baños térmicos mejoran la estabilidad de la temperatura del agua, facilitan su calentamiento además de permitir una enorme comodidad en su vaciado y, lo que es más importante, un ahorro de un 30% en energía.

Todas la series de baños térmicos noon están equipadas con tapa estanca, asa y desagüe.

Thermal containers improve water temperature stability, make its heating easier, allow comfortable emptying, and save up to 30% of energy.

All our Noon thermal baths series are equipped with a sealed cover, a handle and a drain.

80/0040  
Tapa  
Waterlight cover

Para baños GN 1/1  
For GN 1/1 baths

27 L

80/0044  
Container térmico inox con tapa  
Stainless Steel thermal container with lid



## Noonie en las cocinas profesionales

Noonie in professional kitchens

En las cocinas tenemos equipos potentes para asegurar producciones, pero también necesitamos equipos de menor potencia en las partidas, para producciones de menor volumen, regeneraciones, desayunos, buffets, sifones, salsas, etc.

In the kitchens we have powerful equipment to ensure production, but we also need less powerful equipment in the batches, for smaller volume production, regenerations, breakfasts, buffets, siphons, sauces, etc.

### ¡Aviso para bartenders y baristas!

Notice for bartenders and baristas!

Circulador rápido para volúmenes medios y pequeños, compatible en la propia barra de servicio. No renuncie a crear sus propias bebidas calientes, infusiones, etc.

Fast circulator for medium and small volumes, compatible with the service bar itself. Don't renounce to create your own hot drinks, infusions, etc.



80/0097  
Cubeta con tapa Noonie  
Container with cover Noonie

15 L

GN 1/2 20 cm  
GN 1/2 20 cm valid

# Cal Attack

## Descalcificador

Descaler

Limpia la cal y oxidación de las resistencias, bombas de agua, sondas o materiales metálicos o plásticos de los baños térmicos de precisión, baños maría del pase o del buffet, lavavajillas, calentadores de agua, etc.

Mantenga todos sus equipos Sous Vide en perfectas condiciones ahorrando agua y sobre todo electricidad.

Cleans scale and oxidation from electric resistances, water pumps, probes or metal or plastic materials of precision thermal baths, water baths of the pass or buffet, dishwashers, water heaters, etc.

Keep all your sous vide equipment in perfect conditions saving water and electricity.



80/0110  
Cal Attack

700 gr

Dosificación: 50 gr x 10 L  
Disolver y trabajar a 60°C

Dosage: 50 gr x 10 L  
Dissolve and work at 60°C

Sous Vide en ABAC  
Sous Vide at ABAC

YouCook



# vortex

## El agitador al vacío The vacuum stirrer

Consiga emulsiones y texturas sin airear y sin ninguna burbuja de aire sin necesidad de castigar su máquina de vacío.

Mezcla gluconolactato, alginato, goma xantana, gelatina, aceites y estabilizantes, todo en frío.

Achieve impossible emulsions and textures with no ventilation and obtain bubble-free juices without the need to overuse your vacuum machine.

Mix portion of cold gluconolactate, alginate, xanthan gum, jelly, oils and stabilizers.

Use not recommended with fibrous fruit purées or aired products.

20/0007  
Vortex

MODELO COMPATIBLE	230 V / 50 Hz
COMPATIBLE MODEL	110 V / 60 Hz



Descubre todas sus aplicaciones  
Discover all its applications



3000 RPM



Vacío con **Vacuum Pro**  
Sous-vide with **Vacuum Pro**



Vacío con máquina de vacío **iSensor**, con o sin  
conexión externa  
Sous-vide with Vacuum Machine **iSensor**, with and  
without external connection



# BrickVac

Cubetas para vacío  
Vacuum containers

Conserve productos al vacío sin que la presión o la humedad los dañen. Ideal para: verduras, ensaladas, rocas de chocolate o queso, infusiones e impregnaciones de salmueras, jarabes, productos liofilizados o deshidratados, trabajos de azúcar y caramelo, crujientes, pastas y Oblats.

Sous-vide store your products (like salads, greens etc.) without damaging them with pressure or moisture. Now you can easily make chocolate or cheese aero, vacuum brining, vacuum impregnation and so on. BrickVac allows short term storage of freeze-dried or dehydrated products, as well as preserving sugar crafts, caramel, biscuits, crunchy snacks, pastry and Oblats.

Complemente sus cubetas con las conexiones externas para las máquinas de vacío **Vacuum Pro** o **iSensor**.

BrickVac containers also work with external vacuum plugs for **Vacuum Pro** or **iSensor**.



Chocolate blanco Souffl-Air  
White Chocolate Souffl-Air

## BrickVac GN1/1

Cubetas Inox / Stainless Steel containers

80/0080	GN1/1 100 53 x 33 cm Altura / Height: 10 cm 7,6 L
80/0081	GN1/1 150 53 x 33 cm Altura / Height: 15 cm 13 L
80/0082	GN1/1 200 53 x 33 cm Altura / Height: 20 cm 20 L

Tapa policarbonato TRITAN® / TRITAN® Polycarbonate cover cover

80/0084	GN1/1 53 x 33 cm Altura / Height: 4 cm
---------	----------------------------------------

## BirckVac GN1/2

Cubeta Inox / Stainless Steel Container

80/0083	GN1/2 33 x 27 cm Altura / Height: 15 cm 5,6 L
---------	-----------------------------------------------

Tapa policarbonato TRITAN® / TRITAN® Polycarbonate cover

80/0085	GN1/2 33 x 27 cm Altura / Height: 4 cm
---------	----------------------------------------



# iSensor

La nueva generación de envasado al vacío

## ENVASADO INTELIGENTE.

Equipadas con sistema iSensor, para bajos costes en mantenimiento, reparaciones y consumo. Ajusta automáticamente el vacío óptimo para cada producto: incluso líquidos, alimentos húmedos y alimentos porosos. iSensor permite realizar un envasado sin supervisión alguna y optimizar el tiempo de ciclo de envasado de forma automática, permitiendo la perfecta extracción de aire de espumas, masas, y batidos.

## ENVASADO EL DOBLE DE RÁPIDO

Envase dos bolsas superpuestas en la misma posición con el tiempo de una.

## NUEVA ELECTROVÁLVULA

Mejor eficiencia de cualquier ciclo de vacío independientemente de su presión.

80/0060 iSensor S - 230 V  
80/1060 iSensor S - 115 V

8 m<sup>3</sup>/h

Tamaño / Size: 38 x 54 cm

Altura / Height: 38 cm

Barra selladora / Sealing bar: 31 cm



The new generation of vacuum sealing

## INTELLIGENT VACUUM SEALER

Perform the vacuum sealing level for each product: even for liquid, moist or porous foods. iSensor optimizes the packing cycle.

## PACKING IN HALF THE TIME

The special design of the sealing bar makes possible to pack two bags placed on top of each other in the same position. This way, twice the number of bags can be packed in the same amount of time.

Panel de control en modo AUTO o MANUAL  
Control display with AUTO or MANUAL mode



- Modo AUTO  
AUTO mode
  - ▶ Envasa de manera automática sin supervisión
  - ▶ Automatic sealing with no supervision
- Modo MANUAL  
MANUAL mode
  - ▶ Ideal para combinar técnicas culinarias específicas, como impregnaciones, marinados, y colorear y aromatizar
  - ▶ Ideal for combining specific culinary techniques, such as impregnations, marinated, and color and flavor.

LA ENVASADORA AL VACÍO 100% AUTOMÁTICA  
PROGRAMADA PARA INFUSIONES Y OSMOSIS

THE 100% AUTOMATIC VACUUM PACKING MACHINE  
PROGRAMMED FOR INFUSIONS AND OSMOSIS



¿Por qué cocinar al vacío?  
Why use low-temperature vacuum cooking?



- Equipadas con Bomba BUSCH de última generación  
Equipped with the last generation BUSCH pump
- Sistema de autolimpieza del aceite incluido  
Self-cleaning oil system included
- Barra de sellado sin conexiones  
Seal bar without connections
- Cumple con los estándares CE,UL y NSF  
Meets CE, UL and NSF standards

80/0062 iSensor M - 230 V  
80/1062 iSensor M - 115 V **16** m<sup>3</sup>/h

Tamaño / Size: 48 x 56 cm  
Altura / Height: 45 cm  
Barra selladora / Sealing bar: 41 cm



## Conexión para vacío externo External Vacuum Connection

80/0070

Para iSensor /  
Fits iSensor

80/0025

Para Vacuum Pro y Girovap /  
Fits Vacuum Pro and Girovap



80/0064 iSensor L - 230 V  
80/1064 iSensor L - 115 V **20** m<sup>3</sup>/h

Tamaño / Size: 65 x 57 cm  
Altura / Height: 47 cm  
Barra selladora / Sealing bar: 41 x 2 cm

DOBLE  
BARRA SELLADO  
DOUBLE  
SEALING BAR



# VACUUM PRO

Bomba de vacío compacta y portátil  
Compact and portable vacuum pump

La tecnología a doble ciclo: más potente y rápida que la empacadora de sobremesa.

Equipada con conexión externa, compatible con todo tipo de válvulas o envases al vacío, vacuómetro de precisión para controlar el nivel de vacío, fácil mantenimiento y una gran versatilidad para aplicar cualquier técnica de vacío en su cocina.

Double cycle technology: much more powerful and faster than a countertop vacuum machine. Equipped with external connection, it is compatible with all types of valves or vacuum packaging. Equipped with precision vacuum gauge to control the vacuum level.

Vacuum Pro is easy to maintain and features a great versatility to apply any vacuum technique to your kitchen.

## Vacuum Pro

80/0028

230 V - 50 Hz - 150 W

80/0029

115 V - 50/60 Hz - 150 W

4 -4.8 m<sup>3</sup>/hour

CE + UL Certificate

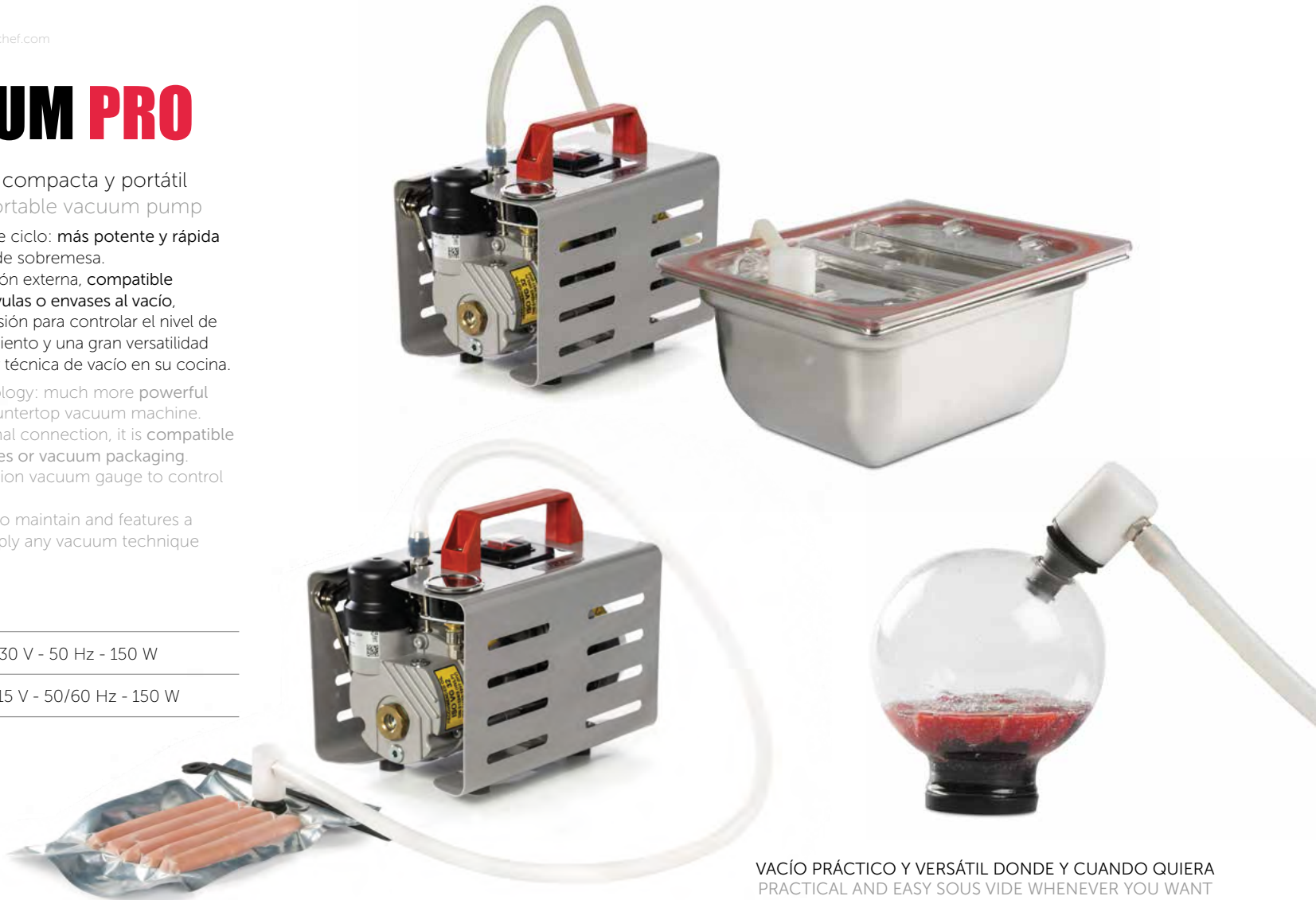

VACÍO PRÁCTICO Y VERSÁTIL DONDE Y CUANDO QUIERA  
PRACTICAL AND EASY SOUS VIDE WHENEVER YOU WANT



80/0025

Conexión Vacuum Pro Standard (recambio)  
External Vacuum Pro connection (replacement)



80/0026

Aceite atóxico para Vacuum Pro  
Vacuum Pro atoxic oil

80 ml

# Spider Pipette

Disco rellenador de pipetas automático  
Automatic disc filler for pipettes

Spider Pipette

80/0023

Disco perforado Spider Pipette /  
Spider Pipette perforated disc

63 Pipetas a la vez  
Pipettes at a time



Sistema compatible con cualquier máquina  
de vacío de campana, Click-it, Vortex, etc.

System compatible with any chamber  
vacuum machine, Click-it, Vortex, etc.



500 uds  
pcs

100/0013

Pipetas gastro / Gastro Pipettes

100/0015

Pipetas mini / Mini Pipettes

# Click-IT

## Sistema de vacío manual Smart Sous Vide System

Click-It es el sistema manual más sencillo para envasar al vacío cualquier tipo de producto sin utilizar ninguna máquina. Válvula con clip reutilizable para transformar cualquier bolsa de plástico o bote en un envase perfecto para el vacío.

Click-It is the simplest system to pack sous-vide any type of product without using a machine. The kit contains reusable clips and valves made to transform any plastic bag or jar into a Sous Vide food container.

80/0093  
Bolsas de cocción Click-It  
Click-It cooking bag

20 uds  
pcs



80/0091  
Click-It Kit

Se incluye / It includes:  
Bomba manual de vacío  
Manual vacuum pump  
3 válvulas / 3 valves  
3 clips / 3 clips  
3 bolsas de cocción Click-It /  
3 Click-It cooking bags



Técnica de vacío Click It  
Click-It vacuum technique



Conservación en botes  
Storage glass container

Impregnación al vacío /  
Vacuum impregnation

Cocina a baja temperatura /  
Vacuum cooking

Conservación en bolsas /  
Vacuum bag storage



# Vac-andsave

Bolsas de conservación para profesionales  
Storing bags for professionals

Perfectas para el empaquetado en fresco de productos de todo tipo.

La gran variedad de tamaños permite adaptar cada envasado a la bolsa idónea.

Permiten congelación y atemperado hasta 85°C en cocciones de corto tiempo de exposición al calor.

El tamaño 20 x 30 cm (80/0106) está específicamente diseñado para trabajar con la emulsionadora a presión Squasher.

Perfect bags for fresh packaging of all kinds of products. The wide variety of sizes allows each packaging to be adapted to the ideal bag. They allow freezing and tempering up to 85°C for short cooking times.

The 20 x 30 cm bag size (80/0106) is specifically designed to work with the Squasher pressure emulsifier.

Grosor  
Thickness **90 microns**

Composición **20 micras Poliamida  
75 micras Polipropileno**

Composition **20 microns Polyamide  
75 microns Polypropylene**

## Conservación / Storing

80/0105	XS	20 x 15 cm
80/0106	S	20 x 30 cm
80/0107	M	25 x 35 cm
80/0108	L	30 x 40 cm
80/0109	XL	35 x 50 cm

500 uds  
pcs



# Vac-andcook

Bolsas de vacío para uso profesional  
Professional use cooking bag

Las bolsas Vac-andcook, al contrario de las bolsas tradicionales, están producidas para resistir y mantener sus propiedades para cocción a baja temperatura y pasteurización.

Vac-andcook bags, on the contrary to the usual bags, are produced to resist and keep its properties for low temperature and slow cooking.

Agua o vapor hasta **+24h** **120°C/248°F**  
Water and steam up to

Microondas y ultracongelación **-40°C/-140°F**  
Microwave and deep-freezing

Grosor **95 microns**  
Thickness

Composición **20 micras Poliamida**  
**75 micras Polipropileno**

Composition **20 microns Polyamide**  
**75 microns Polypropylene**



## Cocción / Cooking

80/0072	XS	20 x 15 cm	100	uds pcs
80/0074	S	20 x 30 cm		
80/0076	XL	35 x 50 cm	50	uds pcs
80/0100	XS	20 x 15 cm		
80/0101	S	20 x 30 cm		
80/0102	M	25 x 35 cm	500	uds pcs
80/0103	L	30 x 40 cm		
80/0104	XL	35 x 50 cm		



Marcadas con el sello de calidad COOKING 120°C / 248°F  
Quality mark COOKING 120°C / 248°F



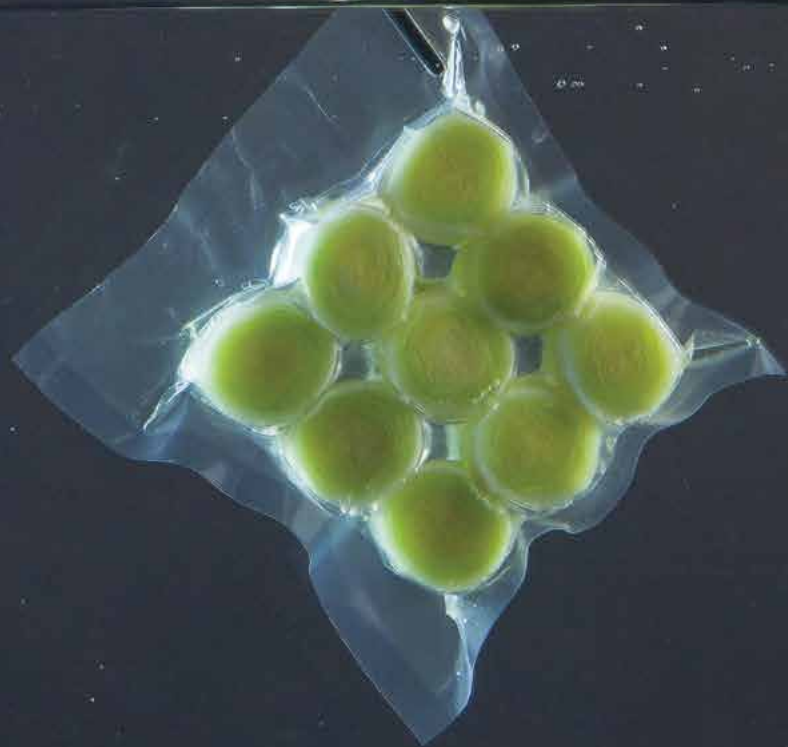

*"El nitrógeno líquido alcanza temperaturas extremadamente bajas en segundos.  
Su capacidad de congelación instantánea preserva aromas y texturas, y abre la puerta a contrastes y efectos visuales que elevan la experiencia gastronómica"*

*"Liquid nitrogen reaches extremely low temperatures in seconds.  
Its instant freezing capability preserves aromas and textures while opening the door to contrasts and visual effects that elevate the gastronomic experience"*





Más info en: / Find out more on:  
www.100x100barman.com

**100% Barman**

**cool\*bar**

Escarchador de copas clásico  
Classic Glasses Froster

Alto rendimiento y mucha rapidez en el trabajo. Enfríe copas y recipientes de cristal o cerámica en segundos, sin necesidad de instalación previa y sin mantenimiento. Coolbar enfría copas y vasos a -45°C instantáneamente.

THE  
BARTENDER'S  
FAVORITE!

Diseñado para un gran volumen de copas, puede ser utilizado en lugares donde su explosividad es irrelevante, tales como clubs, bares o discotecas donde la música es predominante y lo que el cliente busca es rapidez y espectacularidad.

High-performances, quick work. Cool and frost cocktail glasses or any glass or ceramic container in few seconds. Coolbar does not require special tools or maintenance. It can instantly frost glasses and cups up to -45°C.

Designed for high volume production of iced cups: it can be used in places where its noise is irrelevant, such as clubs, bars, crowded places where the music covers the noise and where the customer wants rapidity and spectacular effects.



COBRE / COPPER

120/0028  
CoolBar Classic 230 V

120/0030  
CoolBar Classic 115 V



PLATA / SILVER

120/1028  
CoolBar Classic 230 V

120/1030  
CoolBar Classic 115 V

PERSONALIZADO  
CUSTOMIZED

120/3000



## Nuevas ediciones limitadas New limited edition

Descubre los nuevos acabados de CoolBar que darán un toque de elegancia y sofisticación a tu coctelería, restaurante u hotel.

Discover the new CoolBar finishes that will give a touch of elegance and sophistication to your cocktail bar, restaurant or hotel.

120/0057

CoolBar Classic 230 V - Oro viejo  
CoolBar Classic 230 V - Old gold



120/0056

CoolBar Classic 230 V - Cobre viejo  
CoolBar Classic 230 V - Old copper



## cool❄️bar.2

### Escarchador de copas con Dry Ice Glasses Froster with Dry Ice

#### ¡2 en 1!

CoolBar 2 le permite congelar copas y crear sus propias pastillas de hielo seco y delante del cliente sin tener que cambiar de botella o conexión.

Gracias a su nuevo sistema reductor de salida del gas podrá congelar sus copas en unos segundos y, enroscando el condensador CO2 Dry Ice Black, podrá fabricar pellets de hielo seco al momento. Particularmente silencioso, permite un alto rendimiento en bares de hoteles, restaurantes, coctelerías y lugares que necesiten discreción.

#### 2 in 1!

CoolBar 2 frost your glassware or produce your dry ice tablets on demand, all in front of a client and with no need to change a bottle or connection.

The new gas exit reduction system means you can freeze your glassware in just seconds and with the CO2 Dry Ice Black Condenser attached, you can instantly make dry ice pellets. Particularly quiet. It allows a high performance in lounge bars, and more discrete venues.

CoolBar2 is suitable for RESTAURANTS ·  
LOUNGE BAR · HOTELS

120/2028

CoolBar 2 - 230 V Cobre - Copper

120/3038

CoolBar 2 - 115 V Cobre - Copper

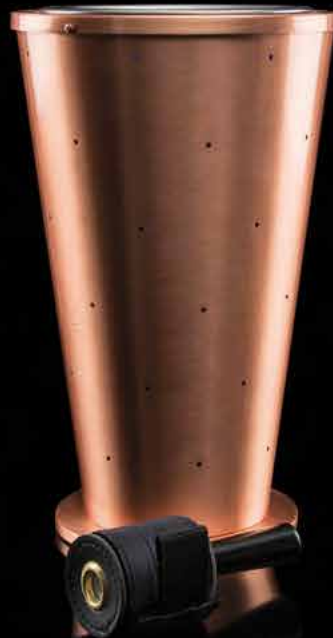

120/4048

CoolBar 2 - 230 V Plata - Silver

120/5058

CoolBar 2 - 115 V Plata - Silver



Dry Ice Black  
incluido / included

Coolbar unplugged

YouCook



FROST GLASSES



DRY ICE PELLETT



-30%  
consumo de CO2  
of CO2 consumption



PRODUCE DRY ICE



Más info en: / Find out more on:  
[www.100x100barman.com](http://www.100x100barman.com)

**100% Barman**



## DRY ICE BLACK

Condensador de hielo seco  
Dry Ice Condenser

Dry Ice Black es el condensador de hielo seco más completo del mercado. Pensado para agilizar el trabajo del profesional frente al cliente, garantiza efectos espectaculares y de calidad.

**RÁPIDO:** menos de 1 minuto para una pastilla de 30 g 12 segundos para pastillas de 11 g.

**EFICIENTE:** reduce el desgaste de CO2 del 30%

**SEGURO:** podrá utilizarlo sin riesgo alguno en cocktelería, buffets, presentación de platos, etc.

**FÁCIL:** Compatible con todas las botellas de CO2 líquido con tubo sonda. Incluye manual de instrucciones.

Dry Ice Black is the most complete dry ice condenser in the market, designed to fasten the professional work and to bring special effect to your venue.

**RAPID:** One 30 g tablet is ready in less than 1 minute. Only 12 seconds to produce a 11 g tablet.

**EFFICIENT:** Equipped with a pressure reduction filter, it lessens the CO2 expense up to 30%.

**SECURE:** Use it safely in cocktail bars, buffets, catering and plate presentation.

**EASY:** Compatible with any liquid CO2 cylinder equipped with probe tube. User guide included.



Ø 5 cm  
30 g in 20 seconds

CO2 - DRY ICE BLACK  
Condensador de hielo seco  
Dry Ice Condenser

120/1015 EU Connection

120/2015 USA Connection

Ø 5 cm  
90 g in 60 seconds

CO2 - DRY ICE BLACK TRIPLE  
Condensador de hielo seco  
Dry Ice Condenser

120/0053 EU Connection

120/0054 USA Connection

120/0046  
DRY ICE PELLETS  
Moldeador instantáneo  
Dry Ice Instant Mold

11 g Pellet  
Ø2 x 2.5 cm



Técnicas nitro y CO2  
Nitro & CO2 techniques



# DRY ICE **BLACK TRIPLE**

Big-production

Las mismas propiedades y facilidad de uso, pero ¡multiplicadas por 3!

Produzca una tableta de 90 g de hielo seco al instante, listo para utilizar, ahorrando tiempo y esfuerzo. Ideal en caterings, coctelerías y restaurantes de gran producción.

The same properties and ease of use, but multiplied by 3!

Produce a 90 g tablet of dry ice instantly, ready to use, saving time and effort. Ideal for caterers, cocktail bars and high production restaurants.



2 uds  
pcs

**120/0047**  
DRY ICE MIXER  
Mezclador de hielo seco  
Dry Ice Stirrer

22 cm



4 uds  
pcs

**160/5109**  
DRY ICE CAPSULE

Ø 2,5 cm x 7 cm

Inserte la cápsula de hielo seco dentro de sus bebidas con seguridad.

Insert the dry ice capsule safely into your beverages.



Disponible también en formato más grande para cócteleras:  
Also available in bigger size for cocktail mixers:  
Mix&Dry Kit - 160/0111

## Nitro Bowl

120/0019	S	∅ 8 cm	125 ml	120/0016	L	∅ 18 cm	0.8 L
120/0018	M	∅ 13 cm	350 ml	120/0029	XXL	∅ 22 cm	2.5 L

Todos los diámetros son exteriores, sin contar el asa / All diameters exclude the handle

Debido al proceso de producción artesanal, las medidas pueden variar hasta  $\pm 20\%$   
Sizes can vary by about  $\pm 20\%$  due to the artisanal creation process

Boles de varios tamaños de doble cámara térmica con vidrio reforzado. Perfectos para elaborar delante del cliente cocktails, helados y sorbetes con LN<sup>2</sup>, así como coctelería molecular u originales presentaciones en cáterings o eventos con hielo seco o LN<sup>2</sup>.

Double-chamber thermal bowls, made with stronger glass, available in different sizes. Prepare perfect liquid nitrogen ice cream and sorbets in front of the client, mix molecular cocktails and original show-cooking for events or catering with dry ice or LN<sup>2</sup>.



## Nitro Glass

120/0017  
Nitro Glass  
0.75 ml  
∅ 9 cm



## Vaso Dewar Dewar Flask

Vaso Dewar con forma de bowl, fabricado en vidrio borosilicato con aislamiento por vacío. Ideal para la elaboración de helados y sorbetes con nitrógeno líquido, así como envase para la cocción en nitrógeno y elaboraciones a la vista del cliente.

Hemispherical Dewar flask, made with borosilicate and vacuum insulated. An indispensable tool for liquid nitrogen cooking, to prepare ice creams and sorbets in front of the client thanks to its perfect capacity.

120/0003  
Vaso Dewar  
Dewar flask



Diámetro interno  
Internal diameter  
Ø 20 cm

## Jarra nitro + Nitro jug +

120/0051	0.6L	Ø 13 x 17 cm
120/0052	1 L	Ø 14 x 21.5 cm

Jarra térmica especial para los trabajos con LN<sup>2</sup>, fabricada íntegramente en acero inoxidable, con doble cámara sellada al vacío. Mantiene el nitrógeno durante horas sin apenas pérdida. Tapón de seguridad especial para nitrógeno.



Técnicas nitro y CO<sub>2</sub>  
Nitro & CO<sub>2</sub> techniques

YouCook

Special thermo jug designed to work with LN<sup>2</sup>. Made entirely of stainless steel, with double vacuum-sealed chamber. It keeps the nitrogen for hours with hardly any loss. With a special security cap for liquid nitrogen.





# Salva-G®

## TEPPAN NITRO

Su gran térmica permite tener un consumo moderado de nitrógeno. La plancha es capaz de llegar a muy bajas temperaturas. Excelente en el trabajo continuo.

The nitrogen consumption is moderate, due to its outstanding insulation properties.

The included radial griddle reaches very low temperatures. Excellent in continuous work.

120/0002  
Teppan Nitro Salva-G

3.5

Teppan: 27 x 21 cm  
Container: 43 x 27 x 15 cm

120/0020  
Plancha adicional para  
Teppan Nitro Salva-G  
Griddle for Teppan  
Nitro Salva-G



3 mm Plancha

Doble cubeta con 2 tapas y 1 plancha

# Salva-G® MINI

Plancha nitro para efectuar trabajos en la mesa del cliente o presentaciones para cocktelería.

Prepare small showcooking directly on the table or the bar.



Cómo usar Teppan Nitro  
How to use Teppan Nitro

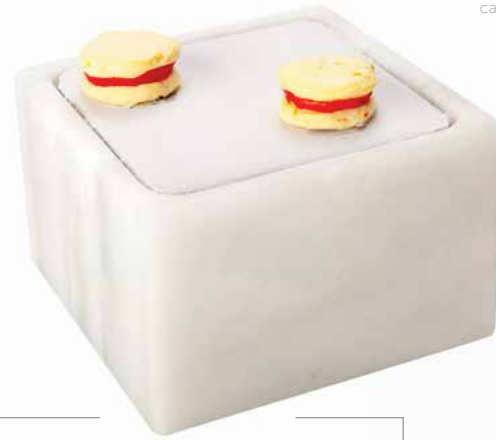

120/0021

Plancha Teppan mini Salva-G  
Teppan nitro mini Salva-G

0.3 L

12 x 12 cm Altura / Height: 9 cm

120/0043

Estuche presentación marmol blanco para Teppan mini  
White Marble Presentation Container for Mini Teppan

14 x 14 cm Altura / Height: 9 cm



Nitro Mould Lollipop

120/0038 Gingerman

120/0040 Mariposa · Butterfly

12 x 12 cm



## Termo Contenedores DEWAR para LN<sup>2</sup> LN<sup>2</sup> DEWAR Insulated Containers

### 120/0027 Transferidor INSTANT INSTANT transfer kit

Permite extraer de manera sencilla y eficaz el nitrógeno líquido de su contenedor. Compatible con cualquier tamaño y marca de contenedor Dewar.

A simple and efficient way to extract liquid nitrogen from your storage tank.

For any Dewar container size or model.



### 120/0004 Par de guantes Nitro Nitro Gloves (pair)



### 120/0012 Máscara de protección Face shield



### 120/0007 Contenedor de nitrógeno Nitrogen Container

Ø: 33 x Altura / Height: 62 cm

20 L



### Conexión NV50

Para todos los modelos  
For all models

### 120/0006 Contenedor de nitrógeno Nitrogen Container

Ø: 30 x Altura / Height: 56 cm

10 L



### 120/0008 Contenedor de nitrógeno Nitrogen Container

Ø: 30 x Altura / Height: 56 cm

30 L



Todos los contenedores llevan funda de protección / All Dewar containers are equipped with protective sleeve



### Nitro Coulant Mould

120/0025 Redondo · Round

120/0026 Cuadrado · Square

4 x 4 cm / Ø: 4 cm  
 Altura / Height: 8 cm

### Spray Nitro

120/0013 300 ml

120/0014 500 ml



Sea un experto en nitrógeno líquido  
 Become an expert in liquid nitrogen



### NITRO Relief

Grabador de bronce macizo con grabado en oblicuo para facilitar el formado de logos o formas en espumas o coulis realizadas en Teppan Nitro Salva-G. Personalizamos todo tipo de formatos, consúltenos, somos especialistas!

Solid bronze seal, customized with diagonal engraving, to perform techniques with liquid nitrogen.

Imprint your logo on mousses, foams and coulis on Teppan Nitro Salva-G. Contact us to get more info and a professional advice.

100/0162  
 Nitro Relief

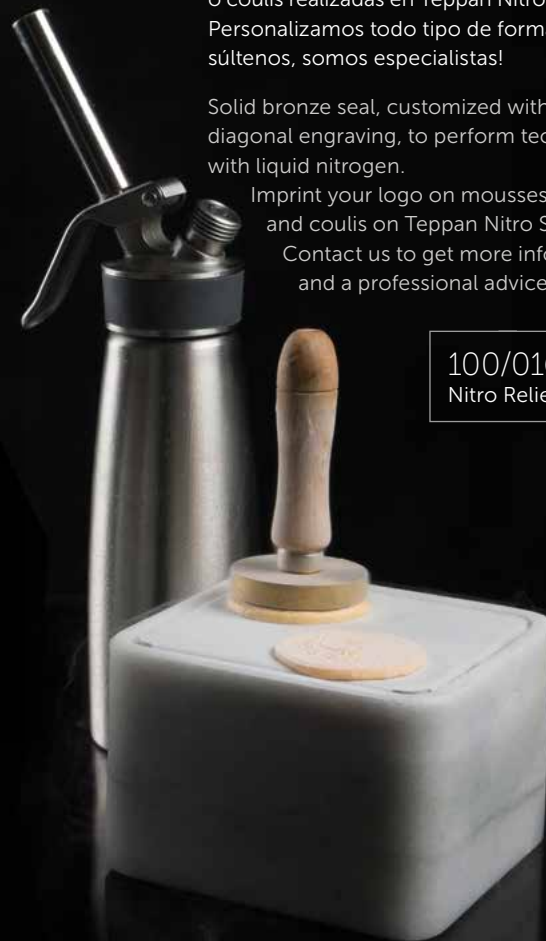

*"Medición y protección para alcanzar la excelencia"*  
*"Measurement and protection to achieve excellence"*



# PRECISION

## MEDICIÓN / MEASUREMENT ..... 173

Control de parámetros de forma detallada  
Detailed parameter control

## PROTECCIÓN / PROTECTION ..... 175

Ambiente limpio y seguro  
Clean and safe environment

## COCINA / KITCHEN ..... 176

Elaboraciones precisas y conservación  
Precise processing and storage



130/0001

Balanza de precisión 0,01 g  
Precision scale 0,01 g

Ideal para el pesaje cotidiano de ingredientes que requieren muy poca cantidad y alta precisión, por ejemplo estabilizantes para helados, azúcares, sal, trufa, especias... Pequeña, extraplana, fácil de usar, alta resistencia a los golpes debido a su caja cierre. Resistente a la caída de líquidos, rapidez en la puesta en marcha y estabilización.

Weigh out ingredients that require a very small amount of high-accuracy measurement. Examples include ice cream stabilisers, sugar, salt and truffle, spices... This small, slim device is easy to use and has a closed box design that provides high shock resistance. It is liquid resistant and starts quickly.

LCD display

Tara / Net tare

Pilas / Batteries (4 x 1,5 tipo / type: R03)

Precisión / Accuracy: max: 100 g / min: 0,01 g



130/0002

Balanza de alta precisión 0,005 g  
High precision scale 0,005 g

Ideal para un uso continuo. Pesa gramos, libras y quilates. Calcula porcentajes y cuentapiezas, paravientos incluido, salida de datos en USB y RS-232-C para impresoras. Puede conectarse a la red eléctrica gracias a su batería recargable. Mueble de acero, y ABS con plato de acero inoxidable, rapidez en la puesta en marcha y estabilización.

Ideal for constant use, both with battery or plugged. It has a stainless steel chassis and an ABS plate with a quick start and stabilisation function. It can weigh in grams, pounds and carats. It has a piece counting function and a percentage mode, as well as wind protection, a USB data output and an RS-232-C printer.

LCD display

Tara / Net tare

Pilas recargables / Rechargeable batteries

Precisión / Accuracy: max: 150 g / min: 0,005 g



130/0003

Medidor digital de PH  
PH digital controller

Phimetro de bolsillo. Mide la acidez o alcalinidad de líquidos. Indispensable para los procesos de gelificación o esferificación. Sensor de temperatura. Totalmente estanco, incluso cuando cae en el agua flota y puede funcionar si está completamente sumergido.

Pocket pH meter. Measures the acidity or alkalinity of liquids. It is essential for gelification or spherification processes. It has a temperature sensor. It is waterproof and floats in water. It can work when completely submerged.

PH: 0.00~14.00pH

Precisión / Accuracy:  $\pm 0.05$ pH

Resolución / Resolution: pH 0.01pH

Temp.: 0~60 °C



130/0004

Medidor digital de salinidad y PH  
Digital salinity & PH controller

Mida y controle el punto de sal de los alimentos en establecimientos, restaurantes, hospitales, escuelas, etc. También es ideal para caterings, industria de la alimentación y establecimientos como restaurantes, hospitales o escuelas.

Accurately measure and control the salt content of food served in your company, restaurant, hospital, school or catering establishment, or in the food industry.

PH: -2.00~16.00pH

Precisión / Accuracy:  $\pm 0.01$ pH

Temp.: 0~60 °C

Salinidad / Salinity: 0.0 – 99.9 ppm 100 – 999 ppm 1–10 ppt

Baterías incluidas / Batteries included

## Termómetro corporal digital con infrarrojos

Mide la temperatura corporal a distancia en 1 segundo. Precisión y rapidez sin necesidad de contacto.

Pantalla LCD con retroiluminación, permite el uso en la oscuridad y cambia de color en función de la temperatura.

130/0022

Termómetro digital infrarrojos  
No contact infrared thermometer

### CARACTERÍSTICAS / FEATURES

Grados Celsius y Fahrenheit  
Celsius and Fahrenheit degrees

Almacena un histórico de hasta 20 mediciones  
It saves the history of the lasts 20 measurements

Alarma para mediciones superiores a 38°C o 100.4°F  
Alarm if the temperature is higher than 38°C or 100.4°F

Apagado automático después de 30 segundos  
Auto power off after 30 seconds

## No contact infrared body thermometer

It measures the body temperature in 1 second with no contact.

High precision and fast with no need for contact. With the backlight LCD screen, it allows the use in the dark and changes colour depending on the temperature.



## Máscara facial

Transparente, con certificado SGS. Indispensable para cocinas centrales, restaurantes, catering, pastelerías, eventos, bares y obradores, manipulación alimentaria y todo tipo de tiendas de alimentación (mercados, supermercados). Evita las salpicaduras de saliva durante el trabajo.

ESTABLE Y CÓMODA: se adhiere al mentón perfectamente gracias a su barra inferior y sus tensores regulables.

USO PROLONGADO: no se empaña, no se mueve, larga duración.

LIMPIA Y TRANSPARENTE: mejora la imagen de su negocio aportando higiene y seguridad y ofreciendo una imagen amable y cuidada.

SOSTENIBLE: puede ser desmontada, desinfectada, reutilizada, y finalmente reciclada.

## Facial mask

Transparent, with SGS certificate. Indispensable for central kitchens, restaurants, catering, pastry shops, events, bars and bakeries, food handling and all types of food stores (markets, supermarkets). Prevents saliva splashes during work.

ERGONOMIC, STABLE AND COMFORTABLE: through its lower bar and its adjustable tensioners, it adheres perfectly to the chin.

PERFECT FOR EXTENDED USE: it does not fog up, it does not move, it has a long life and can be repeatedly cleaned and disinfected with alcohol.

CLEAN AND CLEAR: it improves the image of your business by providing hygiene and safety and offering a friendly and carefully image.

SUSTAINABLE: it can be disassembled, disinfected, reused, and finally recycled.



PERSONALIZABLE  
CUSTOMIZABLE



## Máscara facial Facial cover

10 uds  
pcs

130/0020	Base transparente / Clear lower bar
130/0021	Base blanca / White lower bar



HIGIÉNICA  
CONFORTABLE  
REUTILIZABLE  
  
HYGIENIC  
COMFORTABLE  
REUSABLE



Punta ultrafina para una dosificación perfecta  
Ultra-fine tip for perfect dosage

Botellín precisión  
Squeeze bottle

130/0011	50 ml	50	uds pcs
130/0012	150 ml	10	uds pcs
130/0013	300 ml		



Micro botellines  
Micro squeeze bottle

130/0023	50 ml	20	uds pcs
130/0024	100 ml		

Punta con aguja para trabajos  
muy precisos  
Needle tip for precision work



# Dracula

## Rollo papel absorbente

### Food pad roll

Papel **plastificado y perforado** con base de celulosa natural altamente absorbente.

Su capa plástica **aisla el alimento de la humedad** y la celulosa retiene los jugos. Colocar en el fondo de los envases donde conservamos los pescados, mariscos o carnes crudas, quesos, frutas delicadas, ensaladas, flores, etc., obtendrá un producto de mejor calidad alargando su conservación considerablemente.

La celulosa además regula la humedad del envase alargando la vida del alimento. Consiga neveras libres de olores y contaminación cruzada.

- Conservación óptima.
- Grandes producciones.
- Alimentos más frescos por más tiempo.

Laminated and perforated paper with a base of highly absorbent natural cellulose.

Its plastic layer isolates the food from moisture, while the cellulose retains juices. Place it at the bottom of containers used to store fish, seafood or raw meats, cheeses, delicate fruits, salads, flowers, etc. — you will obtain a higher quality product while considerably extending its shelf life.

In addition, the cellulose regulates the humidity inside the container, further prolonging the freshness of the food. Keep refrigerators free of odors and cross-contamination.

- Optimum preservation.
- Large volume production.
- Fresher food for a longer time.

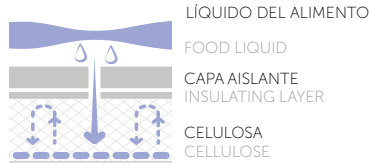

El líquido absorbido no toca el producto  
Liquid is absorbed and cannot touch the food





## Papel japonés para la conservación de pescado Japanese paper for fish preservation

Este papel secante es utilizado en los restaurantes de *sushi* en Japón para conservar el pescado en la elaboración de *makis* o *sashimi*.

Gracias a su altísima capacidad de absorción, este nuevo rollo de papel es ideal para **mantener la frescura** y **conservar por más tiempo** pescados y carnes garantizando una **textura óptima** del producto.

Tunasec está fabricado con celulosa pura no reciclada, no deja pelusas ni residuos sobre el producto, asegurando una manipulación higiénica y profesional. Además, gracias a su alta resistencia, se convierte en un aliado indispensable en cocinas, permitiendo:

- Realizar mejores descongelaciones, extrayendo el agua que pueda soltar el producto.
- Secar grasas de frituras.
- Limpiar entornos profesionales exigentes.

This absorbent paper is used in sushi restaurants in Japan to preserve fish for the preparation of makis or sashimi.

Thanks to its extremely high absorption capacity, this new paper roll is ideal for keeping fish and meat fresh for longer, ensuring the product retains an optimal texture.

Made from pure, non-recycled cellulose, it leaves no lint or residue on the product, guaranteeing hygienic and professional handling. In addition, thanks to its high resistance, it becomes an indispensable ally in the kitchen, allowing you to:

- A better defrosting, extracting the water that may be released from the product.
- Drying frying fats.
- Cleaning demanding professional environments.

80/0042  
TUNASEC

2 uds  
pcs

### Especificaciones / Specifications:

130 m por rollo  
Cortes a 35 cm  
371 servicios por rollo  
Gramaje 300g/m<sup>2</sup>

130 m per roll  
Cuts to 35 cm  
371 services per roll  
Grammage 300g/m<sup>2</sup>



ESCOGE EL ROLLO QUE MÁS SE ADAPTE A TUS NECESIDADES  
CHOOSE THE ROLL THAT BEST SUITS YOUR NEEDS

DRACULA

Mejorar la conservación del producto, alargando su vida útil  
Improving product preservation, extending shelf life

Celulosa con capa plástica perforada  
Cellulose with perforated plastic layer

Se coloca en la base de las bandejas  
Placed at the base of the trays

Aísla el producto y retiene el agua entre capas  
Insulates the product and retains water between layers

Sí, al aislar el producto del agua  
Yes, by isolating the product from the water

Capacidad de aislamiento y limpieza  
Insulation and cleaning capacity

Función principal  
Main function

Composición  
Composition

Modo de uso  
Mode of use

Retención de humedad  
Humidity retention

Otros usos  
Other uses

Evita olores  
Avoids odors

Valor  
Value

TUNASEC

Secar el exceso de agua de pescados y carnes  
Drying excess water from fish and meat

Celulosa comprimida  
Compressed cellulose

En contacto directo o envolviendo el producto  
In direct contact or by wrapping the product

Absorbe el agua directamente  
Absorbs water directly

- Maduración en cámara  
Dry aging in refrigeration
- Conservación de verduras preparadas y limpias para que no suden antes de su cocción  
Storage of prepared and cleaned vegetables so that they do not sweat before cooking
- Humedecido con agua de mar, puede aumentar la vida útil de la pieza de pescado sin secarla y manteniendo su salinidad y PH  
Humidified with sea water, it can increase the shelf life of the fish without drying it and maintaining its salinity and PH

Sí, pero requiere recambio diario para evitar hongos y olores  
Yes, but requires daily replacement to avoid fungus and odors

Versatilidad, limpieza y apoyo a la maduración del pescado  
Versatility, cleanliness and support for fish maturation



# Needle



## Agujas de baño

El accesorio requerido para trabajar los miméticos y otros elementos bañados pequeños.

Gracias a su finura, permite elaborar acabados perfectos (sin marcas); y operar con buena sujeción (para bañar y escurrir).

- Chocolates
- Trufas líquidas
- Falsos esféricos
- Miméticos

## Coating needles

It's the required accessory for working with small coated elements and other mimetics.

Thanks to its finesse, it allows for perfect finishes without marks and provides a good grip for coating and draining operations.

- Chocolates
- Liquid truffles
- False spheres
- Trompe l'oeil

30/0101  
Agujas de baño  
Coating needle

100 uds  
pcs



## O2 Absorber

Sobres que contiene polvo de hierro que actúa de barrera contra la oxidación producida por el aire. Elimina o disminuye el nivel de oxígeno en el embalaje, ayudando a mantener la seguridad alimenticia del alimento y prolongar su vida útil.

En un recipiente correctamente sellado, puede duplicar e incluso triplicar la vida útil del producto a conservar.

This envelope contains iron powder, which acts as a barrier against the oxidation caused by air. It reduces or eliminates the level of oxygen in the packaging, helping to keep food safe and prolong its shelf life.

In a properly sealed container, it can double or even triple the shelf life of the preserved product.

Each sachet can protect up to 100 ml of product.

70/0047  
Oxygen absorber

150 uds  
pcs

1 sobre cada 100 cc.  
1 sachet for 100 cc.





Gel secante de sílice  
Desiccant silica gel

Un secante altamente higroscópico, con una gran capacidad de absorber la humedad ambiental, alargando así la vida útil de secos, liofilizados, caramelos, crujientes y deshidratados.

A highly hygroscopic drying agent with a great capacity to absorb ambient moisture. This extends the shelf life of dried, freeze-dried and dehydrated products, such as candies and crisps.

Disponible en 3 formatos  
Available in 3 formats

70/0044 100 uds  
SilcaBag S 10 g pcs



Pensado para poder disponer una o dos bolsas en botes cerrados y así mantener cualquier deshidratado. Polvo, galleta, caramelo, etc., perfectamente crujiente.

Designed to allow you to place one or two bags in sealed containers, keeping any dehydrated product, such as powder, cookies, candies, etc., perfectly crispy.

70/0045 10 uds  
SilcaBag M 150 g pcs

Añádalo a recipientes de gran tamaño para absorber la humedad en producciones de restaurante, catering y obrador, manteniendo los crujientes, galletas, caramelos, etc., perfectos desde su elaboración hasta su uso.

Add it to large containers to absorb moisture in restaurant, catering, and bakery productions, keeping crisps, cookies, candies, etc., perfect from preparation to serving.

**TO USE:**  
**INSTRUCCIONES DE USO:**

- 1. OPEN THE BAG AND LAY A BASE OF DESICCANT SILICA GEL INTO DIFFERENT RECIPIENTS**  
ABRIR LA BOLSA Y REPARTIR EL GEL DE SÍLICE EN DISTINTOS RECIPIENTES
- 2. KEEP THE REST IN A SEALED JAR OR BAG**  
MANTENER EL RESTO DEL SÍLICE EN UN RECIPIENTE HERMÉTICO
- 3. DO NOT USE IN DIRECT CONTACT WITH FOOD**  
NO USAR EN CONTACTO DIRECTO CON LOS ALIMENTOS
- 4. WHEN THE COLOR CHANGES TO DARK GREEN, PROCEED AS FOLLOWING**  
CUANDO EL COLOR CAMBIE A VERDE OSCURO, REGENERAR

**TO REACTIVATE, DRY AGAIN IN:**  
**PARA REACTIVAR, VOLVER A SECAR EN:**

-  **FOOD DEHYDRATOR: 45°C / 113°F, 48 HOURS**  
DESHIDRATADOR: 45°C, 48 HORAS
-  **OVEN: 120°C / 250°F, 30 MINUTES CYCLES**  
HORNO: 120°C, EN CICLOS DE 30 MINUTOS
-  **MICROWAVE: 700 W, DEFROST, 4 MINUTES CYCLES**  
MICROONDAS: 700 W, DESCONGELACIÓN, EN CICLOS DE 4 MINUTOS
-  **DO NOT OVERHEAT (IT MELTS)**  
NO SOBREALENTAR (SE FUNDE)

70/0046  
SilcaBag L 1000 g

El aliado definitivo contra la humedad. Este formato permite reutilizar el gel de sílice, que puede reactivarse fácilmente mediante secado en horno, microondas o deshidratador. Para detectar fácilmente cuándo hay que renovarlo, Silcabag incorpora perlas naranjas, que cuando se humedecen cambian a color verde.

The ultimate ally against moisture. This bag format allows you to reuse the Silca Gel by drying it to reactivate it in an oven, microwave, or dehydrator. To easily detect when it needs to be replaced, Silcabag incorporates orange beads that change to green when they become damp.



*"Solidez y elegancia esculpida en mármol"*

*"Solidity and elegance sculpted in marble"*



*vinayas*  
PHOTOGRAPHY

## STONE AGE

PLATOS Y BOLES / PLATES & BOWLS ..... 185

CAMPANAS / CLOCHES ..... 207

Platos tallados especialmente para el uso de campanas  
Plates shaped specially for cloche use

SOPORTES / STANDS ..... 210

Para presentaciones originales  
For original presentations

SAL / SALT ..... 215

Placas y soportes  
Blocks and stands

BBQ ..... 217

Frías y calientes  
Cold and hot

## STONE AGE

Platos y soportes tallados en exclusivo mármol de Macael. Todas las piezas son únicas e irrepetibles, talladas y pulidas para ofrecer a nuestro cliente una experiencia única.

Nuestro amplio y original catálogo puede personalizarse a la medida y color en muy poco tiempo de producción y cantidades mínimas.

Plates and stands carved from exclusive Macael marble. All pieces are unique and one-of-a-kind, carved and polished to offer our customers a unique experience.

Our extensive and original catalog can be customized to size and color in a very short production time and with minimum quantities.

190/1004

Reef

10 x 13 cm \*

Alt / Height: 5 cm



## Ebanon

190/1002 Negro · Black Ø 20 cm

190/1003 Marrón · Brown Ø 22 cm

Alt / Height: 3 cm



## Imperator

190/0013 Amarillo / Yellow

190/0014 Verde / Green

190/0101 Rojo / Red

20 x 10 cm \*

Alt / Height: 2 cm

## MÉTODO DE "CURACIÓN" DE PLATOS DE PIEDRA "CURING" METHOD FOR STONE PLATES

Antes del primer uso de nuestros platos de piedra, recomendamos un sencillo tratamiento inicial.

Este tratamiento consiste en una primera limpieza, seguida de la aplicación de aceite alimentario, que se deberá dejar actuar durante 24 horas para una correcta absorción. Pasado este tiempo, se deberán lavar nuevamente y ya estarán listos para su uso.

Este procedimiento puede repetirse periódicamente para conservar sus propiedades y prolongar su vida útil.

We recommend a simple initial treatment before using our stone plates for the first time.

First, clean the plates, then apply cooking oil and leave it to soak in for 24 hours to allow proper absorption. After this time, simply wash the plates again and they will be ready for use.

This procedure can be repeated periodically to preserve the plates' properties and extend their useful life.

Plato rojo *Compagne*  
*Compagne* red plate



Aprende a curar platos de piedra  
Learn how to cure stone plates





190/3002

Plato Air M  
Air plate M

20 x 28,5 cm  
Alt / Height: 2 cm



190/3001

Plato Air L  
Air plate L

26,5 x 28,5 cm  
Alt / Height: 2 cm



190/3000

Plato Air S  
Air plate S

17,5 x 19 cm  
Alt / Height: 2 cm



190/3003

Bandeja Air  
Air tray

14 x 39,5 cm  
Alt / Height: 2 cm

## Air

Esta colección lleva el mármol a su máxima ligereza, logrando piezas de precisión extrema en las que la luz atraviesa el material con naturalidad.

This collection takes marble to its lightest form, achieving pieces of extreme precision in which light passes through the material naturally.



190/3004

Topografic

20,5 x 29 cm  
Alt / Height: 2 cm

2 uds  
pcs

190/1001  
Trevolato

Ø 29 cm  
Alt / Height: 3 cm



190/1008  
Pluma  
Feather

35 x 11 cm  
Alt / Height: 3 cm



Baya cacao  
Cocoa bean

170 ml

190/0055 Verde · Green

190/0056 Blanco · White

21 x 8 cm  
Alt / Height: 6 cm

Ø 11.5 cm



190/1005  
Ovalo

25 x 17 cm  
Alt / Height: 3 cm



\* Las medidas son aproximadas pudiendo variar entre un 20/30% / The marble plates sizes can vary between 20/30%



190/0015  
Rhombus

25 x 24,5 cm  
Alt / Height: 2 cm



### Compagne

190/0111 Verde / Green

190/0112 Rojo / Red

18 x 26 cm Alt / Height: 2 cm



190/1000  
Syro

Ø 35 cm  
Alt / Height: 3 cm



Ø 17 cm

## MÁRMOLES DE COLOR COLORED MARBLE

Un proceso natural acelerado por un sistema único de teñido con pigmentos minerales.

A natural process accelerated by a unique dyeing system with mineral pigments.

190/1015  
Bol coral rojo  
Red coral bowl

700 ml

Ø 18 cm  
Alt / Height: 7.5 cm



190/1010  
Corvus

Ø 20 cm \*  
Alt / Height: 1.5 cm

2 uds  
pcs



Agarre fácil  
Easy to grasp

190/1016  
Intellato

30 x 20 cm  
Alt / Height: 1.5 cm

2 uds  
pcs



### Please note:

The plates may present varied textures and veining with different colours due to the fact that they are made from natural marble. The dyeing may not be uniform due to the different compaction of the natural stone in its quarry. The plates are unique and unrepeatable.

### Atención:

Los platos pueden presentar texturas variadas y veteados con diferentes colores debido a que están fabricados con mármol natural. El teñido puede no quedar uniforme debido a las diferentes compactaciones de la piedra natural en la cantera. Los platos son únicos e irrepetibles.



### Abaco

190/1017 Naranja · Orange

190/1018 Azul · Blue

190/1019 Rojo · Red

2 uds  
pcs

Ø 28 cm  
Alt / Height: 1 cm



Canto rústico  
Rustic Rim





Plato redondo blanco  
White round plate

190/0075 XS Ø 25 cm

190/0076 XL Ø 30 cm

Alt / Height: 3 cm



190/1011  
Abaco Orion

2 uds  
pcs

Ø 25 cm  
Alt / Height: 2 cm



Grabado laser / Laser Engraving

190/0070  
Plato Blonda  
Stone Doily Plate

Ø 20 cm

Plato Al-Ándalus rojo  
Red Al-Ándalus plate

190/0098 XS Ø 25 cm

190/0099 XL Ø 30 cm

Alt / Height: 2 cm

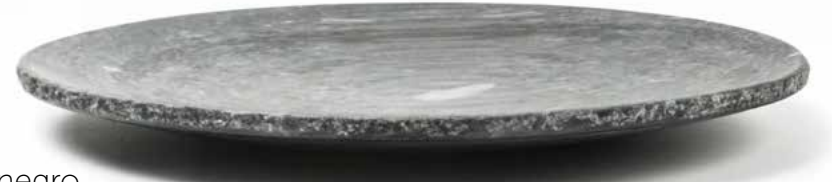

Plato redondo negro  
Black round plate

190/0073 XS Ø 25 cm

190/0074 XL Ø 30 cm

Alt / Height: 3 cm

Negro y rojo con canto rústico  
Black and Red with Rustic Rim

Longo

190/2035 Tray 40 x 16 cm

190/2036 Plate 27 x 12 cm

Alt / Height: 2 cm





## Crocodile

2 uds  
pcs

190/1020 Redondo / Round Ø 25 cm

190/1021 Rectangular 30 x 20 cm

Alt / Height: 1 cm



Bol frío  
Cold bowl

450 ml

190/0077 Vintage

190/0027 Blanco / White

Ø 20.5 cm Alt / Height: 6 cm



Ø 12 cm

190/0079  
Disco Nitro / Nitro Disk  
Ø 14 cm



## Atoll

190/2032 Blanco / White

190/2033 Gris / Grey

190/2034 Sierra Elvira

Ø 27 cm Alt / Height: 2 cm



190/2037  
Cúpula  
Dome

Ø 14,5 cm  
Alt / Height: 7cm



190/0068  
Mini mortero  
Mini mortar

Ø 11,5 x 5,6 cm

6 uds  
pcs





Esfera / Sphere

190/0042 Blanco / White

190/0043 Gris / Grey

Ø 15 cm Alt / Height: 9 cm



190/0039  
Big Sphere

Ø 20 cm  
Alt / Height: 8 cm



190/1013  
Bol Rustic  
Rustic Bowl

300 ml

Ø 18 cm  
Alt / Height: 6 cm

190/1007  
Bol colmena  
Beehive Bowl

250 ml

Ø 18 cm  
Alt / Height: 6 cm

190/1014  
Diamond

600 ml

Ø 18 cm  
Alt / Height: 6 cm





190/1009  
Starfish

250 ml

18 x 8 cm  
Alt / Height: 6 cm

190/0047  
White Moon

Ø 8 cm  
16 x 16 cm  
Alt / Height: 2 cm



Canto Rústico / Rustic Rim

### Imperial

190/0102 Blanco / White

200 ml

190/0103 Gris / Grey

17 x 17 cm Alt / Height: 7 cm



190/0078  
Super Bowl

700 ml

Ø 20 cm  
Alt / Height: 6 cm



## NEKON

Nekon looks like marble, is an innovative material with unique bacteria and its high hardness provides superior resistance. It is easy to clean and its texture does not produce noise or cause abrasion when used with metal cutlery. Light weight and resistant to food acids.

Nekon es un material innovador similar al mármol, con características únicas para la fabricación de platos y piezas de servicio.

Su composición no porosa previene la proliferación de bacterias y su elevada dureza le confieren una resistencia superior.

Es fácil de limpiar, su textura no produce ruido ni causa abrasión por el uso de cubiertos metálicos. Ligero y resistente a los ácidos de los alimentos.

### Agreste

190/2024 Blanco / White

190/2025 Negro / Black

30 x 10 cm Alt / Height: 2 cm



### The hand

190/2030 Blanco / White

190/2031 Negro / Black

24 x 11 cm Alt / Height: 5 cm



### Cave

190/2026 Blanco / White

190/2027 Negro / Black

15 x 13 cm Alt / Height: 5 cm



## Pool

190/2028 Blanco / White

190/2029 Negro / Black

41 x 25 cm Alt / Height: 2 cm

## Silk

190/2038 Blanco / White

190/2039 Negro / Black

19 x 19 cm Alt / Height: 2 cm



## NEKON

Ultra-durable, the Nekon is perfect for heavy-duty use and won't shatter easily and perfect in pool or beach areas.

### CHIP RESISTANT, DOESN'T STAIN

Ultra resistente, el Nekon no se hace añicos, y es perfecto para un uso intensivo, así como apto para áreas de piscina o playa.

### NO SE DESCONCHA NI SE MANCHA



## Panal

190/2022 Blanco / White

190/2023 Negro / Black

Ø 17 cm Alt / Height: 5 cm



Corner plate

190/0037	Simple	8 x 8 cm	2 uds pcs
190/0038	Double	16 x 8 cm	

190/0053	XL	13 x 13 cm
----------	----	------------

190/0054	XXL	20 x 17 cm
----------	-----	------------

Alt / Height: 0.5 cm



190/0064  
Osaka

20x 13 cm  
Alt / Height: 2 cm



190/0092  
Corner Plate Textura Madera  
Wood Textured Corner Plate

20 x 9 cm  
Alt / Height: 0.5 cm

2 uds  
pcs



190/0065  
Tokyo

21 x 21 cm  
Alt / Height: 3 cm

190/0090  
Plato Sushi Mármol  
Marble Sushi Plate

24 x 8 cm  
Alt / Height: 3+1 cm



190/0087

Olla de mármol con tapa cerrada  
Marble pot with lid

300 ml

Ø 15 - Alt / Height: 10 cm

190/0088  
Paleta pintor de mármol  
Marble Painter Palette

23 x 18 cm  
Alt / Height: 1,5 cm





190/0114

Block

4 x 18 cm

Alt / Height: 4 cm

2 uds  
pcs

190/0008

Lágrima / Tear

20 x 9 cm

Alt / Height: 2 cm



Ø 2,3 cm



190/0009

Petit Fours

20 x 7 cm

Alt / Height: 2 cm



190/0001

Roman XS

11 x 22 cm



190/0002

Roman XL

13 x 27 cm



**190/0018**  
Doble Laguna / Double Lagoon **40 ml**

19.5 x 9.5 cm  
Alt / Height: 2 cm



**190/0006**  
Lingote / Ingot

15 x 7 cm  
Alt / Height: 2 cm

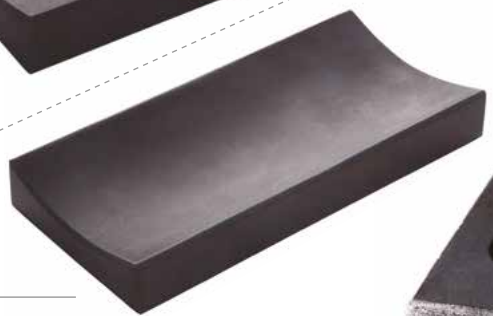

**190/0007**  
Coliseum **30 ml**

10 x 10 cm  
Alt / Height: 2 cm

Ø 7 cm



**190/0017**  
Laguna / Lagoon **60 ml**

18 x 14 cm  
Alt / Height: 2 cm



**190/0034**  
Laguna blanco / White Lagoon **60 ml**

18 x 14 cm  
Alt/Height: 2 cm





lado plano  
flat side



190/0010  
Granito doble cara  
Granite double face

300 ml

22 x 12 cm  
Alt / Height: 4 cm



← lado ahuecado  
hollowed side →



190/0021  
Rústico doble / Rustic double

20 x 10 cm \*  
Alt / Height: 2 cm

190/0011  
Granito / Granite

20 x 15 cm  
Alt / Height: 2 cm



190/0020  
Rústico hondo / Rustic deep

19 x 12 cm \*  
Alt / Height: 2 cm



190/0019  
Rústico llano / Rustic flat

19 x 12 cm \*  
Alt / Height: 2 cm



190/0040  
Meteorite

Ø central 4 cm  
17 x 15 cm \*  
Alt / Height: 2 cm



190/0022  
Fortuna / Fortune

19 x 11 cm  
Alt / Height: 2 cm

190/0023  
Fuente / Fountain

19 x 11 cm  
Alt / Height: 2 cm

190/0041  
Golf

21 x 17 cm \*  
Alt / Height: 2 cm



190/0044  
Circus Purpurina / Glitter Circus

25 x 18 cm  
Alt / Height: 2 cm



Ø 14 cm





### Circus

190/0016 XS 17 x 15 cm

190/0048 XL 25 x 23 cm

Alt / Height: 3 cm



Campanas Aladín / Aladín cloches: 10/0013 - 10/0014



Campanas Aladín / Aladín cloches: 10/0015 - 10/0016



Cover not included.  
It must be ordered separately.

Campana NO incluida.  
Debe encargarse por separado.



190/0080

Plato Apicius  
Apicius Plate

ØExt: 22 cm\*  
Altura / Height: 2 cm



Compatible con / Use with:  
Ø 14 cm, 10/0013 y 10/0014



190/0031

Planet

90 ml

10.5 x 4 cm

Campana incluida  
Cloche included



Ø 14 cm

Campanas Aladín  
Aladín cloches  
(10/0013 - 10/0014)

190/0032

Iceberg

Campana no incluida  
Cloche not included

23 x 20 cm  
Alt / Height: 2 cm

Faraon

190/0028    Amarillo / Yellow

190/0029    Verde / Green

15 x 17 cm \*  
Alt / Height: 2 cm



190/0030

Faraón cúpula recambio  
Spare Faraon cover

Ø 10 cm  
Alt / Height: 10 cm

Campana incluida / Cloche included

Roca porta brochetas  
Rock skewer support

190/0059	Verde / Green	2 agujeros / holes
190/0060	Blanco / White	12 x 6.5 cm - Alt / Height: 5 cm *
190/0061	Verde / Green	4 agujeros / holes
190/0062	Blanco / White	14 x 9 cm - Alt / Height: 7 cm *



190/0089  
Piedra raíz con huecos  
Root stone with holes

10 x 14 cm \*  
Alt / Height: 7 cm



Soporte pinza sushi  
Sushi tong stand

2 uds  
pcs

190/0072-B	Blanco / White
190/0072-G	Gris / Grey
190/0072-V	Verde / Green

\* 9 x 7 cm  
Alt / Height: 4 cm



Hueco/Hole:  
Ø 3 mm

Ramas no incluidas Branches not included

\* Las medidas son aproximadas pudiendo variar entre un 20/30% / The marble plates sizes can vary between 20/30%



Stand corcho  
Cork stand

190/0050	Single	10 x 7 cm
190/0051	Double	12 x 10 cm
190/0052	Triple	10 x 24 cm

Alt / Height: 2 cm

190/0100

Stand de mármol Champagne  
Champagne marble stand

12 x 10 cm  
Alt / Height: 1,5 cm



190/0071

Soporte helados  
Ice Cream Tray

14 x 7 cm  
Alt / Height: 2 cm



190/0091

Posa cubiertos  
Cutlery Support

12 x 4 cm  
Alt / Height: 2.5 cm

4 uds  
pcs



190/0045  
Cube

Ø 4 cm  
6 x 6 cm  
Alt / High: 6 cm



190/0104  
Rubicube

9 x 9 cm  
Alt / High: 9 cm

190/0036  
Soporte cono Macael  
Macael Cone Support

Ø 4.5 cm 8 x 8 cm  
Alt / High: 8.5 cm



Dado  
Dice

6 uds  
pcs

190/0066 Pinzas y brochetas / Tongs and skewers

190/0067 Conos / Cones

5 x 5 x 5 cm







Puente / Bridge

190/0026 25 x 6.5 cm Alt / Height: 6 cm

190/0096 XS 14 x 6.5 cm Alt / Height: 5.5 cm

Huevos de porcelana no incluidos  
Porcelain eggs not included

Caesar

- |          |                   |                                                                                     |
|----------|-------------------|-------------------------------------------------------------------------------------|
| 190/0003 | Amarillo / Yellow |  |
| 190/0004 | Verde / Green     |  |
| 190/0005 | Gris / Grey       |  |



15 x 11 cm \*  
Altura / Height: 10 cm

Bloque de sal no incluido  
Salt block not included



190/0007  
Coliseum





Soporte mármol  
Marble support

- |          |                   |
|----------|-------------------|
| 170/0005 | Amarillo / Yellow |
| 170/0007 | Azulado / Bluish  |
| 170/0008 | Gris / Grey       |

15 x 10 cm \*  
Alt / Height: 12 cm

Para planchas de / For block sizes:

 10 x 10 cm  
Alt / Height: 2 cm

 10 x 14 cm  
Alt / Height: 2 cm

El Kit se compone de / The kit includes:

Base mármol

Marble base

Tubo de ensayo 90 ml

One 90 ml probe tube

Tapón negro de silicona

Silicone black cap

Accesorios extra / Extra accessories:

Cepillo para limpieza / Cleaning brush:

Ref. 100/0145, pag.353.

Tubos y tapones extra / Extra tubes and caps:

Ref. 100/0172,100/0173, pag.322.



190/0081

Kit Soporte Labo Soup  
Test Tube Soup Kit

12.5 x 6 cm

Alt / Height: 3.5 cm

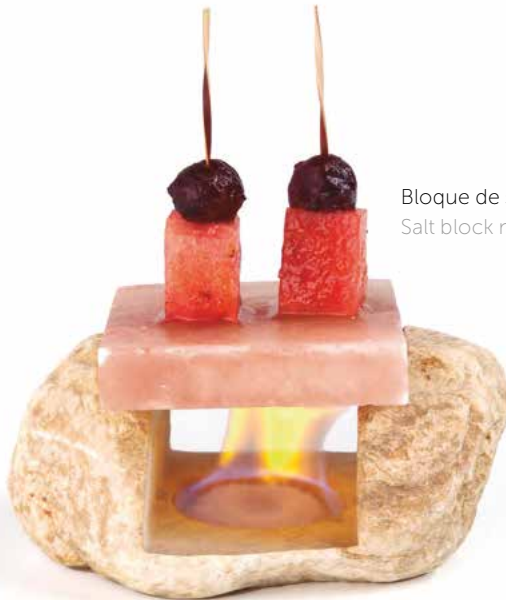

Bloque de sal no incluido  
Salt block not included



190/0063

Roca porta conos  
Yellow Cones Support

9.5 x 9 cm \*

Alt / Height: 7 cm

2 agujeros / holes

190/0113

Paradiso Club

8 x 19 cm Ø 1,6 cm

Alt / Height: 5 cm



\* Tubo de ensayo no incluido

\* Probe tube not included

# Himalaya

## Salt blocks

Salt crystal plates can be heated or cooled to reach extreme temperatures, from  $-196^{\circ}\text{C}$  to direct fire. The surface of the salt transmits the temperature evenly. The thickness of the block keeps the temperature up to 20-30 minutes.



## Planchas de sal

La placa de cristal de sal puede ser calentada o refrigerada llegando a temperaturas extremas, desde  $-196^{\circ}\text{C}$  hasta el fuego directo. La superficie transmite la temperatura de forma uniforme. El grosor del bloque mantiene la temperatura durante 20-30 minutos.



170/0004

Plancha de sal  
Salt block

29 x 21 cm

Alt / Height: 4 cm

170/0002

Plancha de sal rectangular  
Rectangular salt block

14 x 10 cm

Alt / Height: 2 cm

170/0001

Plancha de sal cuadrada  
Square salt block

10 x 10 cm

Alt / Height: 2 cm

170/0003

Soporte metal Himalaya  
Himalaya metallic support

40 x 24 cm

Alt / Height: 14 cm

Para ref / For ref: 170/0004



**AISI  
316**

Acero inoxidable  
Stainless-steel

Salt block not included.  
Designed to be used right  
on your stove or to bring  
hot directly to the table  
and to cook in front of your  
customer.

Bloque de sal no incluido.  
Pensado para calentar encima  
de nuestra cocina o llevar  
la piedra caliente a la mesa  
y cocinar frente a nuestro  
cliente.

Kit Himalaya

170/0006

Kit Himalaya



PARA COCINAR EN LA PROPIA MESA  
SALT BLOCK COOKING SUPPORT

Soporte de dos módulos ensamblables  
(acero inoxidable 18/10)  
Two interlocking modules support  
(Stainless-steel 18/10)

Plancha de sal 29 x 21 x 4 cm  
Pink Himalayan salt block

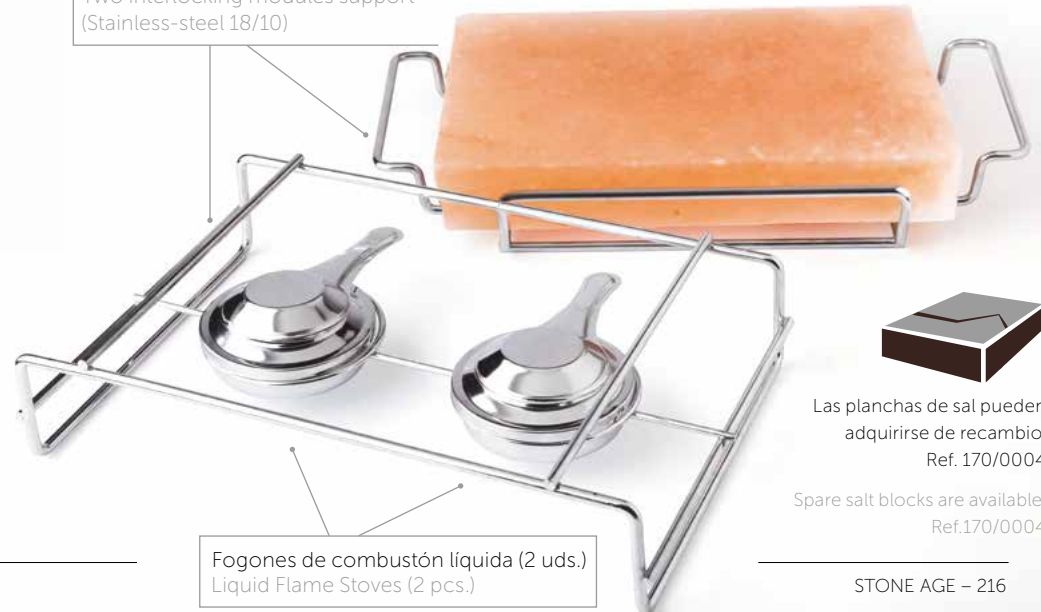

Fogones de combustión líquida (2 uds.)  
Liquid Flame Stoves (2 pcs.)

Las planchas de sal pueden  
adquirirse de recambio:  
Ref. 170/0004

Spare salt blocks are available:  
Ref.170/0004



## Barbacoa Fría / Cold BBQ

190/0115 MINI 16 x 17 cm Alt / Height: 6 cm

190/0024 XS 30 x 11 cm Alt / Height: 6 cm

190/0025 XL 30 x 16 cm Alt / Height: 6 cm



190/0012  
Barbacoa mini  
Mini BBQ

15 x 11 cm\*  
Alt / Height: 10 cm

25 cm



190/0116  
Espeto

13 x 13 cm  
Alt / Height: 4 cm

25 cm





**190/0097**  
Mini Robata  20 cm  
16 x 13 cm  
Alt / Height: 5.5 cm



**190/0069**  
BBQ Charcoal Grill  25 cm  
20 x 13 cm  
Alt / Height: 15 cm

**190/0082**  
BBQ Robata  20 cm  
25 x 16 cm  
Alt / Height: 6 cm



Malla inox media  
Medium Stainless Steel Mesh

 Pincho robata  uds pcs  
180/0008 S 20 cm  
180/0007 L 25 cm



Pinchos y malla no incluidos  
Skewers and Mesh not included

\* Las medidas son aproximadas pudiendo variar entre un 20/30% / The marble plates sizes can vary between 20/30%

*"La combinación de tradición artesanal y funcionalidad contemporánea"*  
*"The combination of artisanal tradition and modern functionality"*





# Porcelain

Redefine la experiencia gastronómica  
Redefine the gastronomic experience

La colección Porcelain deja atrás lo convencional para transformarse a través de formas originales y expresivas. Combina la elegancia de la porcelana con un enfoque creativo para sorprender y elevar la presentación de cualquier plato.

Porcelain collection breaks free from convention, transforming itself through original and expressive shapes. Combining the elegance of porcelain with a creative approach, the collection elevates the presentation of any dish.



## Ondas

210/0128	Plato Snack / Snack plate	Ø 14,5 cm	Alt / Height: 1,5 cm	6	uds pcs
210/0129	Plato M / Plate M	Ø 21 cm	Alt / Height: 1,5 cm	3	uds pcs
210/0130	Plato L / Plate L	Ø 27 cm	Alt / Height: 1,5 cm	6	uds pcs



## Ondas

Ondas es una familia de platos y boles de porcelana diseñados con acabados irregulares que aportan un aspecto orgánico y artesanal. Cada pieza presenta ligeras variaciones en su contorno, generando una estética única

Ondas is a collection of porcelain plates and bowls designed with irregular finishes that create an organic, handcrafted look. Each piece features subtle variations in its contour, delivering a unique aesthetic.



### Ondas

3 uds  
pcs

210/0131	Bowl S	Ø 16 cm	Alt / Height: 3,5 cm
210/0132	Bowl L	Ø 20 cm	Alt / Height: 5 cm



A



D



G

C10958  
Plaisir negro 4 XL  
Plaisir black 4 XL

4 uds  
pcs



B



E



H



C



F



I

C10959  
Plaisir negro 5 XL  
Plaisir black 5 XL

4 uds  
pcs

4 uds  
pcs

## Plaisir

A	C10668	Negro 1.1 / Black 1.1	D	C10671	Negro 3 / Black 3	G	C10674	Negro 6 / Black 6
B	C10669	Negro 1 / Black 1	E	C10672	Negro 4 / Black 4	H	C10675	Negro 7 / Black 7
C	C10670	Negro 2 / Black 2	F	C10673	Negro 5 / Black 5	I	C10676	Negro 8 / Black 8

C10960  
Plaisir blanco 4 XL  
Plaisir white 4 XL

4 uds  
pcs

C10961  
Plaisir blanco 5 XL  
Plaisir white 5 XL

4 uds  
pcs

4 uds  
pcs

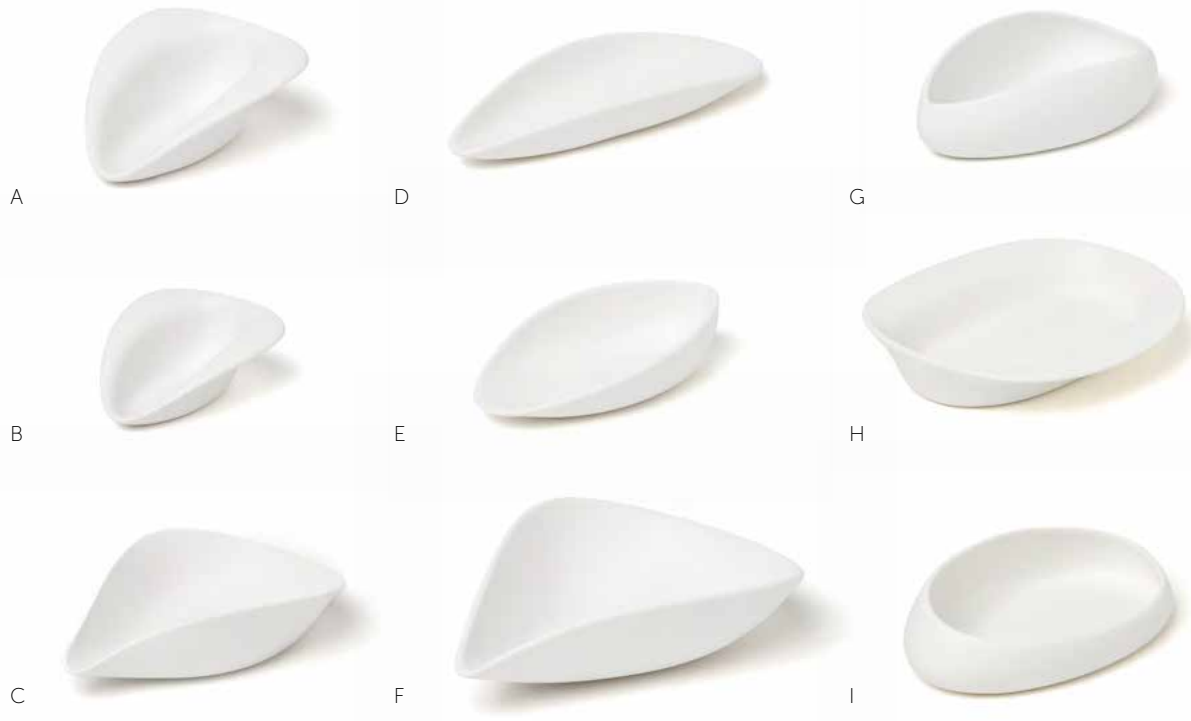

Plaisir

A	C10679	Blanco 1.1 / White 1.1	D	C10682	Blanco 3 / White 3	G	C10685	Blanco 6 / White 6
B	C10680	Blanco 1 / White 1	E	C10683	Blanco 4 / White 4	H	C10686	Blanco 7 / White 7
C	C10681	Blanco 2 / White 2	F	C10684	Blanco 5 / White 5	I	C10687	Blanco 8 / White 8

210/0071  
Gaudí XS

3 uds  
pcs

22 cm x 19 cm

210/0070  
Gaudí XL

3 uds  
pcs

28 cm x 22 cm



210/0127  
Eliptic Snack

6 uds  
pcs

19 cm x 13 Alt / Height: 2,5 cm



Brillo / Glossy

Mate / Matte



210/0069  
Gaudí Bowl

3 uds  
pcs

Ø 20 cm  
Alt / Height: 4 cm

210/0126  
Eliptic

6 uds  
pcs

26 cm x 18 Alt / Height: 3 cm



## Dim Sum

C11588	Ø 12,8 cm
C11590	Ø 18,6 cm



C10591  
Peana redonda blanca  
Round white base

3 uds  
pcs

C10592  
Peana redonda negra  
Round black base

3 uds  
pcs

C10593  
Peana oval  
Oval base

3 uds  
pcs



## Dune XS

---

210/0060 Brillo / Glossy

210/1060 Mate / Matte

Ø 23 cm Alt / Height: 7 cm



## Dune taco

---

210/0061 Brillo / Glossy

210/1061 Mate / Matte

Ø 17 cm Alt / Height: 7 cm



## Dune Snack

---

210/0133 Brillo / Glossy

Ø 17 cm Alt / Height: 5 cm



## Dune L

---

210/0134 Brillo / Glossy

Ø 25 cm Alt / Height: 4 cm



## Dune XL

---

210/0059 Brillo / Glossy

210/1059 Mate / Matte

Ø 27 cm Alt / Height: 7 cm



210/0115  
Dune Craqueler Taco

Ø 17 cm  
Alt / Height: 7 cm



210/0115  
Dune Craqueler XS

Ø 23 cm  
Alt / Height: 7 cm

210/0114  
Dune Craqueler XL

Ø 27 cm  
Alt / Height: 7 cm





210/0026  
Long Rock

Plato / Plate: 12.5 x 9.5cm  
32 x 15 cm Alt / Height: 10 cm

210/0029  
Mini Rock

Plato / Plate: 13 x 5 cm  
17 x 8 cm Alt / Height: 4 cm



210/0030  
Soup Rock

600 ml

Ø 14 cm Alt / Height: 10 cm



Interior textura brillo  
Glossy texture inside



Brillo / Glossy

210/0028  
Small Rock

Plato / Plate: 15 x 6 cm  
22 x 10 cm Alt / Height: 6 cm

Mate / Matte

210/0027  
Big Rock

Plato / Plate: Ø 10 cm  
22 x 19 cm Alt / Height: 8 cm



210/0120  
Long Rock Deco

Plato / Plate: 12.5 x 9.5cm  
32 x 15 cm Alt / Height: 10 cm



210/0121  
Mini Rock Deco

Plato / Plate: 13 x 5 cm  
17 x 8 cm Alt / Height: 4 cm



210/0122  
Big Rock Deco

Plato / Plate: Ø 10 cm  
22 x 19 cm Alt / Height: 8 cm



210/0123  
Small Rock Deco

Plato / Plate: 15 x 6 cm  
22 x 10 cm Alt / Height: 6 cm





## SPHERIC

Inspirada en diseños y formas repetidas en multitud de culturas de los 5 continentes, esta vajilla permite emplatar aperitivos, líquidos, platos de cuchara o bebidas e incluso petit fours.

Inspired by designs and shapes repeated in cultures of the 5 continents, this tableware allows you to serve appetizers, liquids, spoon dishes or drinks, even petit fours.

### Spheric Dome

210/0104 Blanco / White

210/0112 Tabaco / Tobacco

210/0108 Negro / Black

Ø 16 cm Alt / Height: 10,5 cm



### Spheric Plate

210/0103 Blanco / White

210/0111 Tabaco / Tobacco

210/0107 Negro / Black

Ø 23 cm Alt / Height: 6 cm

\*Spheric Dome no incluido

\*Spheric Dome not included





### Spheric Bowl

210/0102 Blanco / White

210/0110 Tabaco / Tobacco

210/0106 Negro / Black

Ø 16 cm Alt / Height: 8,3 cm

\*Spheric Dome no incluido

\*Spheric Dome not included



### Spheric Sake

210/0101 Blanco / White

210/0109 Tabaco / Tobacco

210/0105 Negro / Black

Ø 12,5 cm Alt / Height: 5,5 cm

## SOFT TEXTURES

Piezas de porcelana con textura que imitan fibras o materiales, necesitará tocarlas para ver que no son de verdad. Ligeras y sorprendentemente realistas, permiten agasajar a sus clientes con presentaciones únicas y fuera de lo común.

Porcelain pieces with a texture that imitates fibres or materials. It is impossible to understand what it is made from!

Lightweight as feathers and surprisingly realistic, it allows to entertain your customers with unique and out of the ordinary presentations.

210/0025  
The Pillow

2 uds  
pcs

24 x 24 cm  
Alt / Height: 7 cm



Acabado negro mate  
imitando el hierro  
Black Matte Finish  
mimicking iron

210/0096  
Viga de porcelana  
Porcelain Beam

22 x 9 cm - Alt / Height: 11 cm

210/1203  
The mini pillow

4 uds  
pcs

17 x 17 cm  
Alt / Height: 5,5 cm



280/1203  
Croquet pillow

3 uds  
pcs

25 x 13 cm  
Alt / Height: 2,5 cm





Gorro Ski  
Ski Beanie

210/0074 Blanco / White

210/0085 Azul / Blue

29 x 19 cm Alt / Height: 2 cm



210/0075  
Sinatra

25.5 x 21.5 cm  
Alt / Height: 11 cm



210/0124  
Plato Nopal  
Nopal plate

3 uds  
pcs

31,5 x 5 cm Alt / Height: 1,5 cm



210/0125  
Plato Nopal XL  
XL Nopal plate

45 x 19 cm Alt / Height: 3 cm





3 uds  
pcs

210/0139  
Azada

25 x 16 cm  
Alt / Height: 4 cm

Spa Drink XS 175 ml

210/0048 Blanco / White

210/0097 Oro / Gold

15 x 7 cm Alt / Height: 7 cm



Spa Drink XL 300 ml

210/0049 Blanco / White

210/0098 Oro / Gold

17 x 8 cm Alt / Height: 9 cm

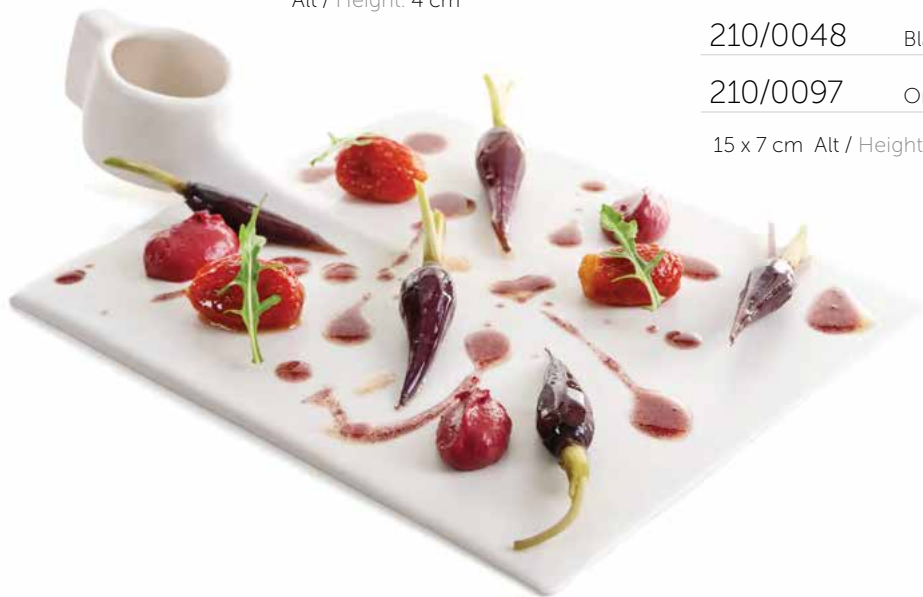

3 uds  
pcs

210/0100  
Sponge Porcelain

11 x 6,5 cm  
Alt / Height: 3,5 cm



## Vasos / Cups

Añade un toque tropical a tu mesa con nuestra colección de vasos de porcelana inspirados en la cultura polinesia. Con diseños de tótems tradicionales y disponibles en cuatro colores, son perfectos para presentar cócteles de forma original y divertida.

Bring a tropical touch to your table with our collection of porcelain tumblers inspired by Polynesian culture.

Featuring traditional totem designs and available in three colours, they're perfect for serving cocktails in a fun and original way.



210/0137  
TOTEM  
Vaso cóctel nácar  
Nacre cocktail cup

3 uds  
pcs

450 ml

Ø 8 cm Alt / Height: 14 cm



210/0046  
TIKI TIKI  
Pack de vasos cóctel 3 colores  
3 colour cocktail pack

3 uds  
pcs

450 ml

Ø 8 cm Alt / Height: 14 cm



## Globus XS

210/0091 Azul / Blue

210/0092 Amarillo / Yellow

210/0093 Blanco / White

210/0094 Negro / Black

210/0095 Rosa / Pink

20 x 16 cm

Alt / Height: 7 cm

Más medidas y colores disponibles bajo demanda

More sizes and colors available on demand



## Globus XL

210/0056	Rosa / Pink
210/0086	Azul / Blue
210/0087	Amarillo / Yellow
210/0088	Blanco / White
210/0089	Negro / Black

23 x 20 cm  
Alt / Height: 7 cm

Más medidas y colores disponibles bajo demanda  
More sizes and colors available on demand



210/0058  
Globus Bowl

500 ml

Ø 13 cm  
Alt / Height: 15 cm



Ø 10 cm





210/0078

Bandeja trenzada de porcelana  
Porcelain Braided Tray

30 x 15 cm

Alt / Height: 2 cm



210/0077

Plato trenzado de porcelana  
Porcelain Braided Plate

24 x 24 cm

Alt / Height: 2 cm

Panera de porcelana  
Porcelain Bread Basket

210/0079 XS Ø 21,5 x 1,5 cm

210/0080 XL Ø 26 x 1,5 cm





Tela de saco  
Burlap plate

3 uds  
pcs

210/0073 XS 22 cm x 18 cm

210/0072 XL 27 cm x 21 cm



210/0039  
The Frame

Plato / Plate: 17 x 13 cm  
Marco / Frame 23.5 x 18.5 cm  
Alt / Height: 2.8 cm

Solicítelo con marco dorado  
Ask for golden frame



## Caníbal

Colección inspirada en elementos naturales, la réplica del original permite presentar esta variedad de piezas en exclusivos platos de porcelana.

## Cannibal

Inspired by the original natural shapes, they allow presenting food in its original form transformed into a porcelain dish.



210/0016  
Paletilla  
Shoulder Blade

Textura mate  
Matte Texture

33 x 20 cm Alt / Height: 6 cm



210/0020  
Brocheta Hueso  
Bone Skewer

3 uds  
pcs

Textura mate  
Matte Texture

Largo / Length : 18 cm



210/0017  
Gran Femur  
Big Femur

Textura mate  
Matte Texture

25 x 10 cm Alt / Height: 10 cm



TEXTURA:  
interior esmaltada  
exterior mate

TEXTURE:  
glossy inside  
matte outside



## Huevos porcelana Porcelain eggs

10 uds  
pcs

210/0082 Blanco / White

210/0083 Naranja / Light brown

210/0084 Rosado / Blush pink

Ø 4.5 cm Alt / Height: 4 cm

Todos los modelos combinan con los siguientes soportes:  
All the models combine with the following supports:  
P/68637, 190/0096





210/0022  
Huevo Roto  
Broken Egg

10 uds  
pcs  
50 ml

Ø 4.5 cm Alt / Height: 5 cm

210/0119  
Huevera  
Egg holder

2 uds  
pcs

9 x 9 cm Alt / Height: 3 cm



210/0023  
Huevo avestruz  
Ostrich Egg

2 uds  
pcs  
350 ml

Ø 8 cm Alt / Height: 10 cm \*



210/0081  
Caracola  
Seashell

350 ml

20 x 13 cm  
Alt / Height: 9 cm



Nacarado / Pearly



210/0099  
Pulpo a feira

22 x 20 cm  
Alt / Height: 5 cm



210/0118  
Mejillón  
Mussel

18 x 9 cm  
Alt / Height: 2 cm

3 uds  
pcs



210/0076  
Txangurro  
Spider Crab

13 x 13 cm  
Alt / Height: 3 cm

175 ml

210/0117  
Escargot

22 x 20 cm  
Alt / Height: 5 cm

Pruebe a ahumar sus escargots!  
Try smoking your escargots!



210/0140  
Buey de mar  
Brown crab

20 x 13 cm  
Alt / Height: 3 cm



210/0064  
Tronco Pequeño  
Trunk Small Plate  
Ø 17 cm  
Alt / Height: 10 cm

210/0065  
Plato Rama Alta  
Branch High Plate  
Ø 9 cm  
Alt / Height: 20 cm



210/0066  
Plato Rama Baja  
Branch Low Plate  
Ø 10 cm  
Alt / Height: 13 cm



## WOOD PLATES

Platos de porcelana simulando la madera natural. Textura, color y diseño realista. Vacío en su interior, lo convierte en un soporte ligero ideal para presentar platos y snacks.

Painted porcelain plate simulating natural wood. Texture, color and realistic design, its slight cavity makes it a stand ideal for the presentation of snacks or dishes.



210/0063  
Tronco Grande  
Trunk Big Plate  
Ø 23 cm  
Alt / Height: 7 cm

210/0138  
Plato Rama Snack  
Branch Snack Plate  
Ø 11 cm  
Alt / Height: 5,5 cm



Carpaccio madera  
Carpaccio wood

3 uds  
pcs

210/0068 XS 22 cm x 18 cm

210/0067 XL 27 cm x 21 cm



210/0040  
Wood Slice

Ø 32 cm Alt / Height: 4 cm

*"Diseño, textura y contraste en cada presentación"*  
*"Design, texture, and contrast in every presentation"*





## Ceramics Era

Creaciones artesanales de gres  
Stoneware plates and supports

Platos y soportes modelados en gres y arcillas refractarias por las expertas manos de nuestros artesanos locales. Utilizando técnicas con esmaltes extremadamente resistentes, son ideales para presentaciones calientes o frías, ya que el material ayuda a mantener la temperatura más tiempo.

Dishes and supports modelled in stoneware and refractory clays by the expert hands of our local craftsmen. Using techniques with extremely resistant glazes. Ideal for hot or cold presentations, because the material helps to maintain the temperature for longer.



Volcanic  
Blanco / White

3 uds  
pcs

280/0055

Plato / Plate    Ø 22 cm    Alt / Height: 2 cm

280/0056

Plato L / Plate L    28 x 26 cm    Alt / Height: 4 cm

280/0057

Bandeja / Tray    31 x 19 cm    Alt / Height: 3 cm



## Volcanic

Piezas de cerámica que destacan por la fuerza visual de sus formas. El grosor de cada pieza permite trabajar bordes irregulares y profundos, generando un acabado que recuerda a la piedra en estado natural.

Ofrece una alta resistencia al desportillado, a los choques térmicos y al desbarasado frecuente.

Ceramic pieces that stand out for the visual strength of their forms. The thickness of each piece allows for irregular, deep edges, creating a finish that recalls natural stone.

It offers high resistance to chipping, thermal shock, and frequent dishwashing.

### Volcanic

Terra

3 uds  
pcs

280/0058	Plato / Plate	Ø 22 cm	Alt / Height: 2 cm
280/0059	Plato L / Plate L	28 x 26 cm	Alt / Height: 4 cm
280/0060	Bandeja / Tray	31 x 19 cm	Alt / Height: 3 cm



PERSONALIZABLE  
CUSTOMIZABLE

Todas nuestras cerámicas pueden ser personalizadas tanto en esmaltes de diferentes colores, combinaciones de color, y acabados especiales.

All our ceramics can be customised both in glazes of different colours, colour combinations, and special finishes.

## GADES



1 L



Gades  
Bol / Bowl

6 uds  
pcs

280/0031

Morena / Moray

280/0034

Blanco / White

280/0032

Gris metálico / Metallic grey

280/0035

Turquesa / Turquoise

280/0033

Arena / Sand

Ø 21 cm Alt / Height: 6 cm

## TARRACO

Platos ultraligeros que gracias a su cámara térmica permiten conservar los alimentos calientes más tiempo una vez emplatados.

Ultra-lightweight plates, their thermal chamber allows food to keep warm for longer once it has been plated.



Tarraco  
Plato / Plate

3 uds  
pcs

280/0021

Morena / Moray

280/0022

Gris metálico / Metallic grey

280/0023

Arena / Sand

280/0024

Blanco / White

280/0025

Turquesa / Turquoise

Ø 25 x 17 cm Alt / Height: 5.5 cm



## Barcino

Bowl

Ø 20 cm Alt / Height: 3 cm

3 uds  
pcs

280/0061

Blanco / White

280/0064

Gris metálico / Metallic gray

280/0062

Morena / Moray

280/0065

Turquesa / Turquoise

280/0063

Arena / Sand

280/0066

Oliva / Olive

## BARCINO

La cerámica refractaria contiene partículas de esmalte del mismo color de la superficie para cada modelo.

The refractory ceramic contains glaze particles of the same colour as the surface for each model.



Barcino  
Plato / Plate

Ø 27 cm Alt / Height: 3.8 cm

4 uds  
pcs

280/0011

Morena / Moray

280/0014

Blanco / White

280/0012

Gris metálico / Metallic gray

280/0015

Turquesa / Turquoise

280/0013

Arena / Sand

280/0067

Oliva / Olive



## Domus

Gris metálico / Metallic

3 uds  
pcs

280/0068	Bandeja / Tray	31 x 21 cm Alt / Height: 1 cm
280/0069	Plato L / Plate L	Ø 26 cm Alt / Height: 1 cm
280/0070	Plato S / Plate S	Ø 21 cm Alt / Height: 1 cm
280/0071	Bowl	Ø 20 cm Alt / Height: 4 cm



## Domus

Domus presenta líneas suaves e irregulares en su forma, discretos detalles que recuerdan al trabajo artesanal y aportan un aspecto más orgánico y natural.

Domus features soft, irregular lines in its shape, with discreet details reminiscent of craftsmanship that give it a more organic and natural look.

### Domus

Arena / Sand

3 uds  
pcs

280/0073	Plato L / Plate L	Ø 26 cm Alt / Height: 1 cm
280/0074	Plato S / Plate S	Ø 21 cm Alt / Height: 1 cm
280/0075	Bowl	Ø 20 cm Alt / Height: 4 cm

## Iluro

Vaporera en miniatura con tapa, compuesta de 3 piezas. Ideal para servir pequeños bocados. Introduzca aromas en su vapor o bruma generada con hielo seco para una mayor experiencia sensorial del cliente.

Miniature steamer with lid composed of 3 pieces, ideal for serving small steamed creations. Introduce aromas in the lower piece, for a greater sensory experience for the customer.

## Iluro

Vaporera /

280/0001

Morena / Moray

280/0002

Gris metálico / Metallic grey

280/0003

Arena / Sand

280/0004

Blanco / White

Ø 12 cm Alt / Height: 11 cm





## Egara

Piezas únicas inspiradas en paletas de pintor y creadas para resistir al uso intensivo diario. Una fusión perfecta entre funcionalidad y diseño.

Unique pieces inspired by painter's palettes and created to withstand intensive daily use. A perfect fusion of functionality and design.

### Egara

Paleta / Palette

4 uds  
pcs

280/0041

Acabado metal / Metal finish

280/0042

Acabado madera / Wood finish

31.5 x 21 cm Alt / Height: 1 cm



280/1214

Maguro

34 x 11 cm

Alt / Height: 17 cm



## CAESAR PALACE

Columnas romanas de acabado envejecido diseñadas para realzar presentaciones de *petit fours* y preparaciones delicadas.

Aged-finish Roman columns designed to elevate the presentation of *petit fours* and delicate creations.

Ø 17 cm Alt / Height: 9 cm



280/0052

Caesar hondo / Deep



280/0054

Caesar hondo liso /  
Deep Smooth Rim



8 42CB32 P5TACH

# Serigrafood

Platos personalizados con sabor  
Customized dishes with flavour

Imprima sobre un plato llano, en tan solo 5 segundos y tantas veces como quiera, cualquier dibujo, escritura, logo o diseño, con salsas, mantequillas, purés de fruta... Con esta técnica puede realizar cualquier diseño y presentar platos de infinitas maneras y sabores.

Screen print on a flat plate in only 5 seconds!  
Customize your dishes by printing logos, designs and writings with handcrafted edible ink made with sauces, flavored butter or fruit purées.  
Who said it's forbidden to play with food?  
Wash the plate and repeat as much as you desire.



## CÓMO FUNCIONA HOW IT WORKS

1. Tensar la tela en el bastidor
  2. Encajar la tela encima del plato
  3. Extender la crema con la ayuda de una espátula
1. Tense the screen on the frame
  2. Place the screen on a perfectly dried plate
  3. Spread the chosen creamy texture with a spatula



## Serigrafood

Rectangular	28 x 43 cm
210/0050	Tela / Canvas
210/0051	Marco / Frame
Cuadrado / Square	43 x 43 cm
210/0054	Tela / Canvas
210/0052	Marco / Frame





# TERRA XTREM

Cerámica para uso intensivo, resistente a la humedad y las manchas de aceites o salsas. No mantiene los olores. No usar con fuego directo.

High resistance ceramic. It prevents the humidity absorption as well as oil and sauce stains. Free from accumulation of smells. Do not use with direct fire.

## TIESTO flower pot

12 uds  
pcs

220/3011	XS	Ø 7 cm Alt / Height: 6 cm	125 ml
220/3010	M	Ø 8 cm Alt / Height: 7.5 cm	175 ml
220/3006	XL	Ø 10 cm Alt / Height: 9 cm	350 ml
220/3009	XXL	Ø 12 cm Alt / Height: 11 cm	600 ml



6 uds  
pcs  
220/3015  
Tejas XS / Roof Tiles XS

7 x 15 x 3.5 cm



2 uds  
pcs  
220/3012  
Roast & Toast TerraXtrem

19 x 12 x 1.5 cm

220/3008  
Bocadillo TerraXtrem

20 x 9 x 5 cm



Especificaciones

Specifications

Fabricada con productos 100% naturales

Made with 100% natural materials

Esmaltes libres de plomo y cadmio

Lead and cadmium free varnish

Resistentes a microondas, horno, lavavajillas y congelador

Microwaves, oven, dishwasher and freezer resistant



*"Diseños que se adaptan y realzan la complejidad de cada presentación"*  
*"Designs that adapt and enhance the complexity of each presentation"*



# GLASS CONCEPTS

TESLA ..... 267

Vasos y campanas con fluorescencia  
Fluorescence cups and bells

CONCEPTS ..... 269

Colecciones de cristalería para la coctelería  
Cocktail glassware collections

SERVICIO DE MESA / TABLEWARE ..... 319

Emplatados y presentaciones  
Plating and presentations

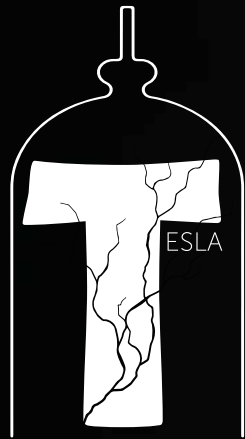

## BAR & COCKTAIL

### TESLA BAR & COCKTAIL COLLECTION

Sirva sus cócteles en vasos donde se emplea la tecnología creada por Nikola Tesla en el año 1893.

La electricidad se transmite por el aire de forma inalámbrica gracias a las bobinas Tesla que hay en el interior de nuestras estaciones.

Esta energía acelera las moléculas del gas Neón (Ne) contenido entre las paredes de vidrio de los recipientes.

La electricidad crea en contacto con el gas una fluorescencia de color rojo producida por este tipo de gas inerte. Otros gases como el helio (He), argón (Ar), kriptón (Kr), xenón (Xe) y radón (Rn) emiten otras gamas de color al paso de la electricidad.

Aprovecha esta tecnología para servir tus cócteles y bebidas de forma espectacular incluso utilizando el posavasos personalizado de su bar entre la base y el vaso.

### TESLA BAR & COCKTAIL COLLECTION

Serve your cocktails in glasses using the technology created by Nikola Tesla in 1893.

Electricity is transmitted through the air wirelessly thanks to the Tesla coils inside our stations. This energy accelerates the Neon (Ne) gas molecules contained between the glass walls of the containers. The electricity creates in contact with the gas a red fluorescence produced by this kind of inert gas. Other gases such as Helium (He), Argon (Ar), Krypton (Kr), Xenon (Xe) and Radon (Rn) emit other color ranges when electricity passes through them.

Take advantage of this technology to serve your cocktails and drinks in a spectacular way even using the personalized coaster of your bar between the base and the glass.

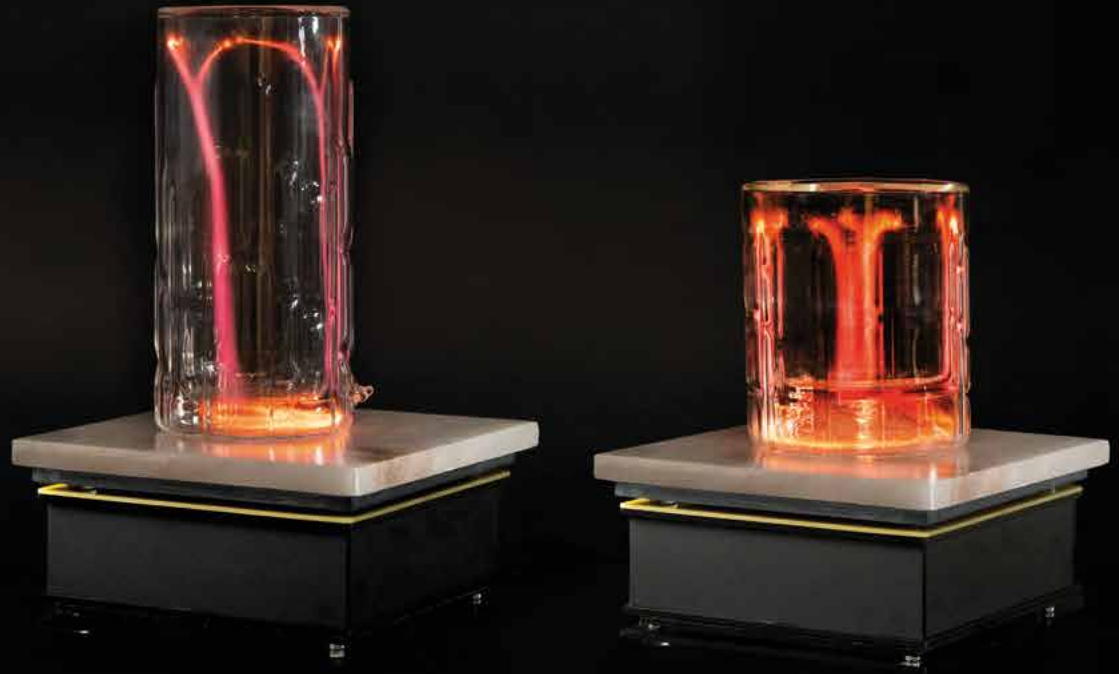

160/5094

Campana Tesla Ne  
Tesla Cloche Ne

Ø 12 cm

Alt / Height: 25 cm



160/5110

Estación portátil Tesla  
Portable Tesla Station

13 x 13 cm

Alt / Height: 4,5 cm

AC 100-240V 50/60 Hz

160/5091

Base Tesla Red  
Tesla Base Plug-in

13 x 13 cm

Alt / Height: 4,5 cm

AC 100-240V 50/60 Hz



160/5120

Base Tesla negra Red  
Tesla base black Network

13 x 13 cm

Alt / Height: 4,5 cm

AC 100-240V 50/60 Hz

160/5121

Tesla inalámbrica negra  
Wireless Tesla base black

13 x 13 cm

Alt / Height: 4,5 cm

AC 100-240V 50/60 Hz

160/5092

High Ball Tesla Ne

Ø 7,5 cm

Alt / Height: 16 cm

400 ml



160/5093

Vaso Whisky Tesla Ne  
Tesla Whisky Glass Ne

Ø 9 cm

Alt / Height: 10 cm

300 ml



160/5129  
MANNEQUIN

220 ml

Ø 8 cm  
Alt / Height: 20 cm  
Pajita incluida  
Straw included



160/5127  
HEEL

170 ml

13 cm x 5,5 cm  
Alt / Height: 15 cm  
Pajita incluida  
Straw included



160/5126  
DIAMANTE

350 ml

Ø 11 cm  
Alt / Height: 16 cm  
Pajita incluida  
Straw included



SHINE BRIGHT  
LIKE A DIAMOND!

160/5068  
Diamond\*

2 uds  
pcs

250 ml

10 x 11.5 cm  
Alt / Height: 11.5 cm

Pajita incluida  
Straw included





4 uds pcs  
**160/5125**  
CUBIK CUP 300 ml  
6 x 6 cm  
Alt / Height: 18 cm

4 uds pcs  
**160/5123**  
CUBIK ROCKS 400 ml  
8 x 8 cm  
Alt / Height: 8 cm



4 uds pcs  
**160/5124**  
CUBIK HIGH GLASS 450 ml  
6 x 6 cm  
Alt / Height: 16 cm





160/5135  
OVNI

250 ml

Ø 13 cm  
Alt / Height: 7 cm



160/5131  
ROTUNDA

660 ml

Ø 10 cm  
Alt / Height: 17 cm

Pajita incluida  
Straw included





160/5133  
Copa Gintonic Cloud  
Gintonic Cloud glass

600 ml

Ø 10 cm  
Alt / Height: 21 cm



160/5132  
Copa Cloud  
Cloud glass

200 ml

Ø 7 cm  
Alt / Height: 17 cm



160/5134  
Vaso Cloud  
Cloud cup

400 ml

Ø 8 cm  
Alt / Height: 10 cm





160/5115  
DONUT

2 uds  
pcs

380 ml

13 x 4 cm Alt / Height: 12 cm

Pajita incluida  
Straw included





160/5085  
THIRST EXTINGUISHER

300 ml

13 x 9 cm Alt / Height: 19 cm



160/5116  
CANTIR

300 ml

10 x 9 cm Alt / Height: 15 cm

Pajita incluida  
Straw included

160/5025  
MILKSHAKE\*

330 ml

Ø 9.5 cm Alt / Height: 13.5 cm

Fabricados  
artesanalmente en  
borosilicato

Handcrafted  
with  
Borosilicate



\*Incluye una pajita de vidrio / Glass straw included.

Más info en: / Find out more on:  
[www.100x100barman.com](http://www.100x100barman.com)

**100%Barman**



160/5044  
COCKTAIL SHAKER\* 400 ml

Ø 7 cm Alt / Height: 13 cm



160/5086  
AMAZONIC CUP 210 ml

12 x 12 cm Alt / Height: 19 cm





400 ml

160/5081  
TODO CORAZON\*

10 x 10 cm  
Alt / Height: 20 cm

277 - GLASS CONCEPTS



170 ml

160/5107 2 uds  
COPA TWIST MARTINI

Ø 10,5 cm  
Alt / Height: 20 cm



250 ml

160/5108 2 uds  
COPA TWIST FLAUTA

Ø 5,5 cm  
Alt / Height: 23 cm

160/5038 400 ml  
SUPER LONG DRINK

Ø 10 cm  
Alt / Height: 34 cm

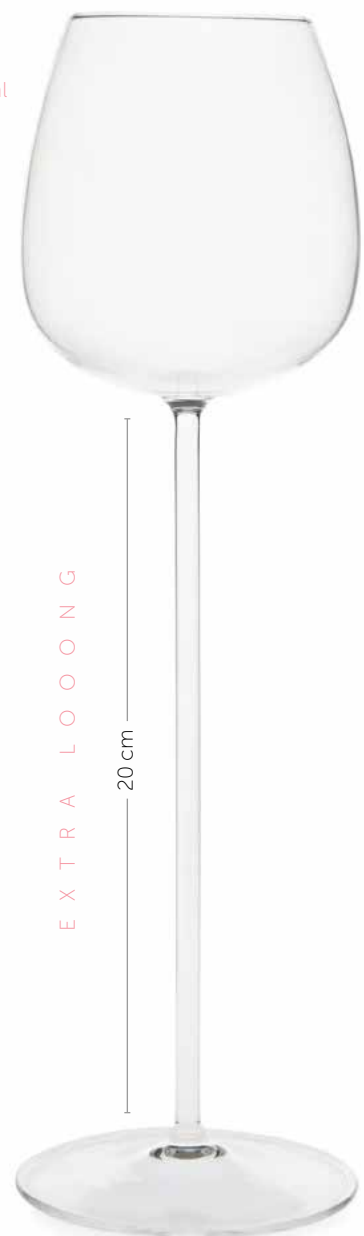

EXTRA LOONG  
20 cm



260 ml

160/5087  
ICE CREAM

2 uds

Ø 9 cm  
Alt / Height: 20 cm



160/5042  
SOLERO\*

110 ml

Ø 8 cm  
Alt / Height: 22 cm



Más info en: / Find out more on:  
[www.100x100barman.com](http://www.100x100barman.com)

**100% Barman**

\*Incluye una pajita de vidrio / Glass straw included.

Más info en: / Find out more on:  
[www.100x100barman.com](http://www.100x100barman.com)

**100% Barman**



**160/5031**  
PIGGY BANK\*

360 ml

15 X 9 cm  
Alt / Height: 9 cm



Fabricados artesanalmente en borosilicato  
Handcrafted with borosilicate in Spain

**160/5035**  
PENGUIN\*

350 ml

11 cm x 10 cm  
Alt / Height: 15 cm



**160/5111**  
ATLAS\*

600 ml

Ø 11 cm Glass  
11 x 17 Alt / Height: 20 cm Kit



160/5024  
ALADDIN

230 ml

20 cm x 7.5 cm  
Alt / Height: 12 cm

160/5036

CINDERELLA PUMPKIN\*

340 ml

19 X 11 cm  
Alt / Height: 17 cm

Desmontable para su limpieza  
Removable for cleaning



160/5030  
SWEET CANDY\*

290 ml

18 x 9 cm  
Alt / Height: 9 cm



THE  
ALECHEMIX  
LABORATORIO CREATIVO

Más info en: / Find out more on:  
[www.100x100barman.com](http://www.100x100barman.com)

**100% Barman**

## AIRE DE MAR

Colección inspirada en formas del mar, que recrea corales y animales marinos con la intención de aportar nuevas presentaciones tanto en bebidas como en presentación de platos.

## SEA BREEZE

Inspired by sea shapes, this collection delves into the forms of corals and marine animals with the intention of contributing new presentations in both drinks and presentation of dishes.



160/0089  
GREEN ALGAE

250 ml

Ø 8.5 cm  
Alt / Height: 13 cm



160/0091  
RED CORAL

250 ml

Ø 8.5 cm  
Alt / Height: 13 cm



160/0088  
MINI CORAL REEF

2 uds  
pcs

60 ml

Ø 5 cm  
Alt / Height: 10 cm

160/0120  
OCTOPUS

250 ml

Ø 8.5 cm  
Alt / Height: 13 cm



160/0090  
ESTRELLA DE MAR  
STARFISH GLASS

150 ml

Copa / Glass: Ø 8 cm  
Base: Ø 18 cm  
Alt / Height: 11 cm



160/0087  
CORAL REEF

250 ml

Ø 8.5 cm  
Alt / Height: 13 cm



160/6002  
SQUID\*

280 ml

Ø 10 cm  
Alt / Height: 23 cm



## MEDUSA

160/0085    Transparente · Clear

160/0086    Rosa · Pink

Ø 10 cm  
Alt / Height: 16 cm

100 ml



## BIG MEDUSA

160/0130    Transparente · Clear

160/0134    Rosa · Pink

Ø 11 cm  
Alt / Height: 19 cm

200 ml





125 ml  
160/0050  
Erizo / Sea Urchin

Ø ex. 17 cm  
Ø in. 7 cm

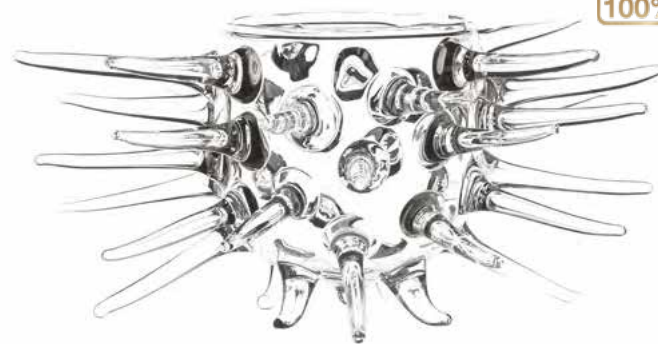

100% Barman

150 ml  
160/0058  
Erizo Alto / Tall Sea Urchin

Ø ex. 15 cm  
Ø in. 5.5 cm

160/5070  
Erizo Gigante\*  
Giant Sea Urchin\*

300 ml

Ø ex. 18 cm  
Ø in. 8.5 cm



150 ml  
160/5101  
Erizo Stand\*  
Stand Sea Urchin\*

2 uds

Ø ex. 14 cm  
Ø in. 7 cm  
Alt / Height: 15 cm

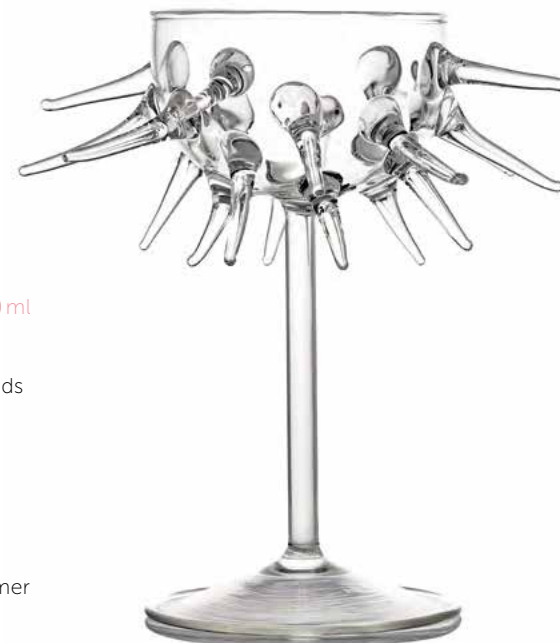

\*Copa para beber o comer  
\*Glass for Eat & Drink



**160/5104** 300 ml  
Erizo Gigante Snow\*  
Giant Snow Sea Urchin\*  
Ø ex. 18 cm  
Ø in. 8.5 cm

Nuestro Erizo con efecto Snow,  
igual de elegante, igual de espectacular.

Our Snow Effect Urchin, just as elegant,  
just as spectacular.

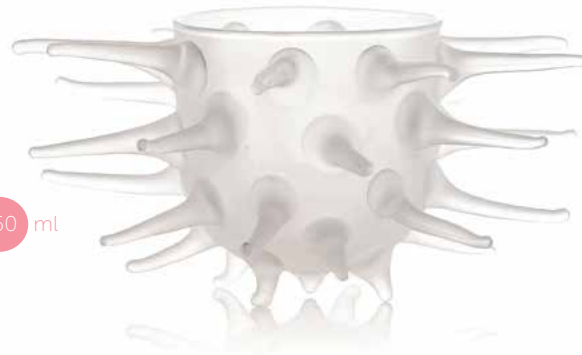

**160/5103** 150 ml  
Erizo Alto Snow  
Tall Snow Sea Urchin

Ø ex. 15 cm  
Ø in. 5.5 cm

**160/5102** 125 ml  
Erizo Snow  
Snow Sea Urchin

Ø ex. 17 cm  
Ø in. 7 cm



Más info en: / Find out more on:  
[www.100x100barman.com](http://www.100x100barman.com)

**100%Barman**

**160/0049**  
OSTRA / OYSTER

Ø 12 cm  
Alt / Height: 13 cm



**160/0092**  
CARACOL DE MAR  
SEASHELL

250 ml

8.5 x 16 cm  
Alt / Height: 8.5 cm



**160/0046**  
CAÑAILLA / MUREX SEA SNAIL

21 x 10 cm  
Alt / Height: 12 cm

**160/0047**  
CARACOLA SNOW XS  
SEASHELL

50 ml

15 x 8 cm



Fabricados  
artesanalmente en  
borosilicato

Handmade  
Artisanal  
Borosilicate

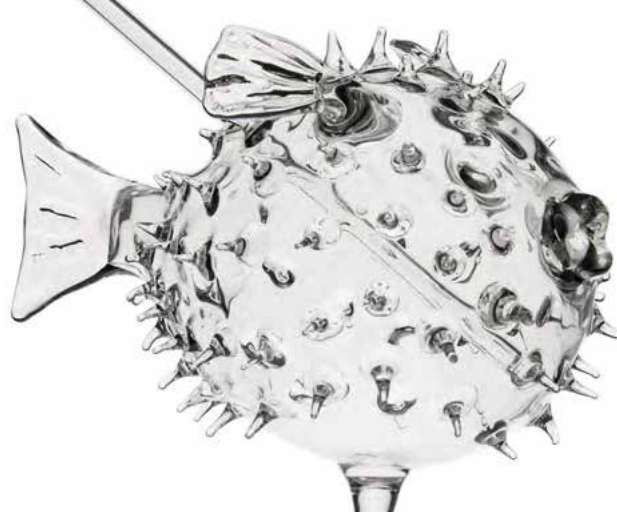

160/5066  
BLOWFISH

140 ml

18 x 13 cm  
Alt / Height 8 cm



\*Incluye una pajita de vidrio / Glass straw included.



160/0093  
FUGU\*

250 ml

16 x 10 cm  
Alt / Height: 22 cm

160/0096  
PERA / PEAR\*

400 ml

Ø 11 cm  
Alt / Height: 18 cm



## VEGETALIA COLLECTION

Inspirado en la variedad de formas de la fruta, plantas o flores, estas originales copas despiertan los sentidos y añaden un toque fresco y original a sus bebidas y creaciones.

Inspired by the fruit shapes diversity, this collection wakes up the senses and gives an original fresh touch to your drinks and creations.

Designed with a special hole to fill with ice and a smaller hole for straw. Made of borosilicate withstands hard daily work, blows and scratches.

\*Incluye una pajita de vidrio / Glass straw included.

Agujero especial para  
rellenar el vaso con hielo.  
Special hole to fill with ice.

Ø 3 cm

Pajita de vidrio incluida  
Glass straw included

Agujero para caña  
Hole for straw



160/0094  
APPLE\*

250 ml

Ø 11 cm  
Alt / Height: 14 cm





Fabricados artesanalmente en borosilicato  
Handcrafted with borosilicate in Spain

Más info en: / Find out more on:  
[www.100x100barman.com](http://www.100x100barman.com)

**100% Barman**



160/5021  
BACCHUS\*

330 ml

24 cm x 24 cm  
Alt / Height: 12 cm



160/5064  
BANANA\*

250 ml

23 x 5 cm  
Alt / Height: 10 cm

160/0097  
ANANAS\*

300 ml

Ø 9 cm  
Alt / Height: 23 cm

Ø 3 cm

Agujero especial para  
rellenar con hielo.  
Special hole to fill with ice.

Agujero para caña  
Hole for straw

160/0095  
MANGO\*

400 ml

Ø 11 cm  
Alt / Height: 17 cm

\*Incluyen una pajita de vidrio / Glass straw included.

160/0043  
LEMON XL

125 ml

24 x 10 cm

160/0044  
LEMON XS

75 ml

19 x 7 cm



iPlato tropical!

Tropical plate!

160/0045

PIÑA / PINEAPPLE

60 ml

31 x 9 cm

Alt / Height: 9 cm





160/0098  
LACTARIUS\*

150 ml

Ø 15 cm  
Alt / Height: 13 cm

www.rfoodrevolution.com

160/5027  
BOLETUS\*

370 ml

Ø 9 cm Alt / Height: 14 cm



160/5028  
TOMATO\*

500 ml

Ø 12 cm Alt / Height: 10 cm



Más info en: / Find out more on:  
[www.100x100barman.com](http://www.100x100barman.com)

100% Barman

160/0083  
CORNUCOPIA

350 ml

Ø 8 cm  
Alt / Height: 21 cm



Saber más en / Know more on:  
[www.100x100barman.com](http://www.100x100barman.com)

100% Barman

160/0079  
VIKING

350 ml

Ø 8 x 20 cm  
Alt / Height: 19 cm



160/5045  
HEART\*

290 ml

Ø 9 cm  
Alt / Height: 21 cm



THE  
ALCHEMIX  
GASTRO-COCKTAIL BAR

160/5090  
TETRABRICK XL

900 ml

7 x 7 cm Alt / Height: 25 cm



293 – GLASS CONCEPTS



160/5039  
CHRISTMAS BALLS

4 uds  
pcs

240 ml

Ø 9 cm  
Alt / Height: 11 cm

El pack incluye 4 pajitas de vidrio  
The pack contains 4 glass straws.

160/5001  
BRICK

400 ml

8 cm x 10 cm  
Alt / Height: 10 cm



210 ml

310 ml



160/5032  
MOLECULAR\*

17 x 9 cm  
Alt / Height: 9 cm

\*Incluye una pajita de vidrio / Glass straw included.

160/5083  
SKEWER GLASS\*

250 ml

Ø 6 cm Alt / Height: 13 cm



160/5082  
COOKIE BAG\*

250 ml

6 cm x 11 cm  
Alt / Height: 13 cm



160/5084  
PIERCING GLASS\*

250 ml

Ø 6 cm Alt / Height: 13 cm



Más info en: / Find out more on:  
[www.100x100barman.com](http://www.100x100barman.com)

**100% Barman**

# FUN SHISHA

## Shisha cocktail individual Personal hookah cocktail

Consiga únicas y sorprendentes sensaciones fumando un delicioso y aromático cocktail. Rellene su vaso de hielo, frutas, hierbas aromáticas, verduras, flores, ... añada una combinación de alcoholes y zumos, y utilizando las piedras de carbón de coco y tabaco aromatizado, podrá preparar infinitos cocktails vaporizados.

Experience the surprising sensation of smoking a delicious and aromatic cocktail. Fill the glass with ice, fruits and aromatic herbs, vegetables, flowers, combination of alcohols and natural juices...

Using scented tobacco and coconut coal you can prepare infinite vaporized cocktails.



160/0115  
Fun Shisha Baby

0.5 L

Ø 12 cm  
Alt / Height: 32 cm

MIX  
tobacco  
&  
fruit

160/0068  
Fun Shisha

1 L

Ø 14 cm  
Alt / Height: 40 cm



## LITHIUM

### Disco Luz LED LED Light Disc



10 uds  
pcs

100/1017  
Lithium disco luz LED  
Lithium LED light disc

Ø 5 cm



Fácil aplicación  
Easy application

Haga de su terraza o zona de fumadores un lugar único y privilegiado  
Turn your terrace or smoking area into a special and privileged place



Saber más en / Know more on:  
[www.100x100barman.com](http://www.100x100barman.com)

**100% Barman**





Fly like a Bird! & Drink like a Bird!

160/0138  
Fly like a bird\*

200 ml

15 x 6 cm  
Alt / Height: 18 cm

Pajita incluida  
Straw included

Con alas para  
guarniciones o aperitivos

With wings for garnishes  
or bite-sized appetizers

160/0069  
Drink like a bird\*

200 ml

15 x 6 cm  
Alt / Height: 18 cm

Pajita incluida  
Straw included



\*Incluye una pajita de vidrio / Glass straw included.



160/0019

Kit Smoke & Drink  
Pipa & soporte  
Pipe & Support

100 ml

6 x 16 cm  
Alt / Height: 7 cm

160/0029

Pipa repuesto  
Spare glass pipe

Ø ex. 5,5 cm



160/0067

Pipa Sherlock  
Sherlock Pipe

150 ml

20 x 7 cm  
Alt / Height: 9 cm

Ø ex. 5,5 cm



## CAT CUP & FAT CAT CUP



160/0008 350 ml  
Cat cup

Ø 6 cm  
Alt / Height: 18 cm  
Ø ext. 8 cm

160/0013 200 ml  
Mini Cat cup

Ø 4,5 cm  
Alt / Height: 16 cm  
Ø ext. 6 cm

Copas ideales para servir bebidas con hielo seco o sopas con diferentes temperaturas o texturas. Diseño apto para utilizar con Cocktail Master o herramientas parecidas.

The ideal cup to drink with dry ice or soups of different temperatures and textures. Design suitable for using with Cocktail Master or any similar tool.

Boca ancha para añadir cubitos de hielo o fruta  
Wide mouth to add ice cubes or diced fruits

Ø 5.5 cm



160/0082 300 ml  
Fat Cat Cup

Ø ext. 8 cm

Más info en: / Find out more on:  
[www.100x100barman.com](http://www.100x100barman.com)

**100%Barman**

**160/5033**  
ABSINTHE

250 ml

10 x 9 cm  
Alt / Height: 19 cm



Desmontable para su limpieza / Removable for cleaning

Fabricados  
artesanalmente en  
borosilicato



Handcrafted  
with  
Borosilicate



**160/5034**

POPPY BULB OPIUM 240 ml

8 x 9 cm  
Alt / Height: 22 cm



THE  
**ALCHEMIX**  
GASTROCOCKTAIL BAR

160/0007

Chupito ensayo  
Test shot

4 uds  
pcs

30 ml

Ø 1.2 cm

Alt / Height: 13 cm



160/5065

Chupito XL  
Shot XL

60 ml

Ø 2.8 cm

Alt / Height: 19 cm

## Chupitos creativos Creative shots



Ø 1.2 cm

2 uds  
pcs

160/0015

Chupito doble  
Double shot

2x30 ml

Alt / Height: 15 cm

160/0065

Columbia

2 uds  
pcs

2x80 ml

Alt / Height: 19 cm

Ø 2.8 cm



Ø 2 cm

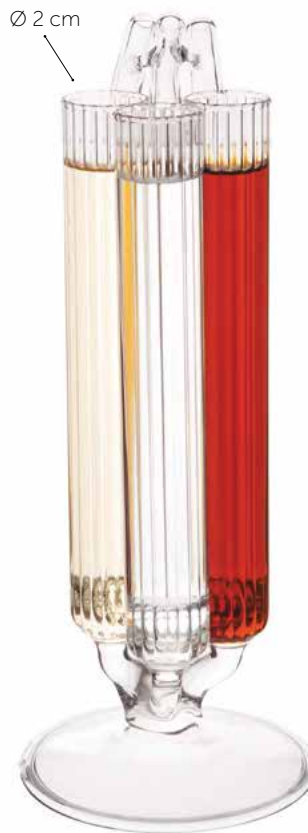

160/0066

Orgasmic

3x53 ml

Alt / Height: 19 cm



BLACKBERRY STEM 2 uds pcs

160/0118 XL Ø 2.5 - Alt / Height: 20 cm 90 ml

160/0119 XS Ø 2.5 - Alt / Height: 15 cm 50 ml



CACTUS

160/5029 XXL Ø 2.2 - Alt / Height: 24 cm 210 ml 1 ud pc

160/0116 XL Ø 3 - Alt / Height: 20 cm 100 ml 2 uds pcs

160/0117 XS Ø 2.2 - Alt / Height: 16 cm 50 ml



Fabricados artesanalmente en borosilicato



Handcrafted with Borosilicate

DRY  
MARTINI  
By  
JAVIER DE LAS MUELAS



160/5079  
MOKA CUP\*

500 ml

9 x 11 cm Alt / Height: 19 cm



160/0059  
RETRO

170 ml

Ø 9 cm  
Alt / Height: 7 cm



160/0102  
RETRO CUP TAIL

170 ml

Ø 9 cm  
Alt / Height: 17 cm



160/0101  
TEA CUP TAIL

200 ml

Ø 8 cm  
Alt / Height: 18 cm

# VICTORIAN Cocktail Cup



Taza de porcelana  
con pie de vidrio torneado

Porcelain Cup with  
glass handcrafted stem

2 uds  
pcs

160/0124  
VICTORIAN COCKTAIL CUP

200 ml

Ø 9 cm Alt / Height: 13.5 cm



P/68648  
Pinza soporte conos  
Clamp Cone Support



VERSAILLES

2 uds  
pcs

160/0141  
VERSAILLES COCKTAIL CUP

200 ml

Ø 10,5 cm Alt / Height: 13.5 cm



350 ml

160/0121  
WOOD TRUNK

20 x 13 cm  
Alt / Height: 17 cm

160/0122  
Wood Trunk  
Replacement Glass

Ø 9 cm  
Alt / Height: 8 cm



160/0137  
KIT APPLE WOOD TRUNK

20 x 13 cm  
Alt / Height: 17 cm  
Incluye base de madera y vaso  
Includes wood base and glass

160/0133  
Wood Trunk Apple Glass

Ø 11 cm  
Alt / Height: 14 cm



250 ml

160/5080  
ROLLING CUP

20 x 13 cm  
Alt / Height: 17 cm

250 ml



\* La capacidad de los productos puede variar ligeramente debido a su proceso de fabricación artesanal

Fabricados  
artesanalmente en  
borosilicato



Handcrafted  
with  
Borosilicate

## SNOWFLAKE

230 ml

160/5049 MARTINI

160/5050 MARGARITA

160/5051 COUPETTE

Ø 11 cm Alt / Height: 19 cm



Base matizada efecto hielo  
Ice-effect matte base



Snowflake  
Collection

# 1/2 COCKTAIL

The perfect aperitif

Degustar cocktails en medias copas,  
¡qué gran idea!

Tasting cocktails in half glasses,  
what a great idea!

2 uds  
pcs

160/0056

Aperitivo mini  
Mini Appetizer

110 ml

Ø: 8 cm Alt / Height: 7 cm

Probeta  
Test tube cup

2 uds  
pcs

160/0052 Normal

160/0057 Graduada / Graduated

Ø 3 cm  
Alt / Height: 25 cm

60 ml

160/0003

Aperitivo / Appetizer

110 ml

Ø 8 cm  
Alt / Height: 16 cm



2 uds pcs  
160/0055  
Sour  
Ø 6 cm  
Alt / Height: 18 cm



2 uds pcs  
160/0051  
Margarita  
Ø 8 cm  
Alt / Height: 16 cm



2 uds pcs  
160/0084  
Copa Amuse  
Amuse Cup  
Ø 6.5 cm  
Alt / Height: 13 cm



2 uds pcs  
160/0054  
Passion  
Ø 8 cm  
Alt / Height: 16 cm



2 uds pcs  
160/0053  
MARTINI  
Ø 10 cm  
Alt / Height: 16 cm



Saber más en / Know more on:  
[www.100x100barman.com](http://www.100x100barman.com)

**100% Barman**



SKULL

160/5004  
Skull Glass

6 uds  
6 pcs

300 ml

12 cm x 9 cm  
Alt / Height: 9 cm  
Pajita no incluida  
Straw not included



309 - GLASS CONCEPTS

Saber más en / Know more on:  
www.100x100barman.com

100% Barman

Ø 10 cm



TAKE YOUR TIME

160/0103  
Take your time

300 ml

21 cm

13 cm

Mezcle su cocktail  
como un reloj de  
arena

Mix your cocktail  
inside an hourglass



Caña de 20 cm incluida  
20 cm glass straw included



2 uds  
pcs  
160/5089  
Cacito salsera alto  
Sauce scoop high  
250 ml  
Ø 8 cm Alt / Height: 6 cm



2 uds  
pcs  
160/5088  
Cacito salsera bajo  
Sauce scoop low  
150 ml  
Ø 8 cm Alt / Height: 4 cm



## Jarrita Boro Boro glass jug

A	160/0106	2 Uds/Pcs	Ø 8 cm Alt / Height: 10 cm
B	160/0107	2 Uds/Pcs	Ø 8 cm Alt / Height: 5 cm
C	160/0108	2 Uds/Pcs	Ø 5 cm Alt / Height: 11 cm
D	160/0105	1 Ud/Pc	Ø 8 cm Alt / Height: 15 cm

Jarritas y vasos para salsear, servir jugos, bebidas, jarabes... Fabricados en vidrio borosilicato resistente a lavavajillas.

Basic everlasting jugs and small glasses with pourer designed to serve sauces, juices, drinks, syrups.

Use them while preparing the plates, or directly to serve at the table. Made of borosilicate and dishwasher safe.





Tubo de ensayo gigante  
Giant Test Tube

100/0171 20 Uds/Pcs

100/0172 40 Uds/Pcs

Ø 2.5 x 25 cm

\* Tapón no incluido / Cap not included

90 ml



by  
Javier  
Caballero

6 uds  
pcs

100/0050  
Copa Caballero para tapa cocktail  
Tapa-cocktail "Caballero" cup

Ø 4.5 cm Alt / Height: 10 cm



160/0140  
Fuente Absenta  
Absynt Spring

600 ml

Ø 14,5 cm  
Alt / Height: 37 cm

## PAJITAS DE CRISTAL GLASS STRAWS

Las pajitas de cristal borosilicato son ideales para coctelería molecular. Sienta el frío en los labios!

Borosilicate glass straws are ideal for molecular mixology. Feel the cold on your lips.



**100/1003**  
Escobilla para pajita  
Straw Brush

2 uds  
pcs

**160/0021**  
Pajita recta gruesa  
Straight glass straw

24 uds  
pcs

Ø 0.9 cm Alt / Height: 20 cm

**160/5098**  
Pajitas Ambar  
Ambar Straws

24 uds  
pcs

Ø 0.8 cm Alt / Height: 20 cm

**160/0022**  
Pajita curva gruesa  
Curve glass straw

24 uds  
pcs

Ø 1 cm Alt / Height: 20 cm

**160/0020**  
Pajita mini-cola  
Mini-cola glass straw

36 uds  
pcs

Ø 0.6 cm Alt / Height: 17 cm



**160/0063**  
Brocheta glass XS  
Glass Skewer XS

10 uds  
pcs

10 cm

**160/0064**  
Brocheta glass XL  
Glass Skewer XL

10 uds  
pcs

14 cm

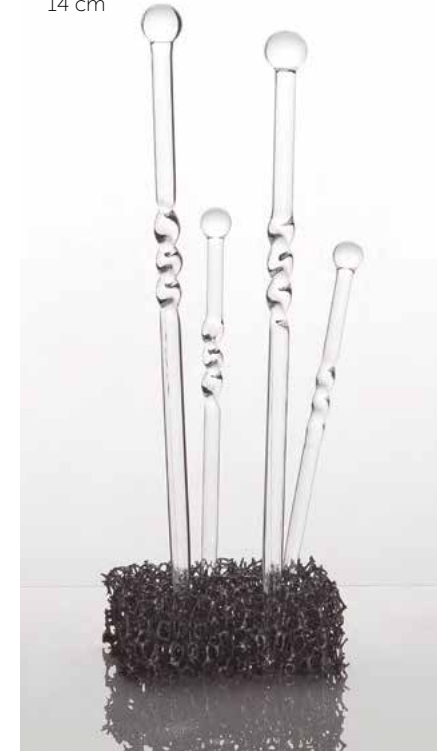



## INFUSION BOWL 4 in 1

Bol de vidrio borosilicato diseñado para acelerar los procesos de saborización de sus bebidas, frutas frescas, etc. Gracias al vacío acelerará la osmosis, integrando todos los sabores en apenas unos minutos, incluso en frío.

Borosilicate glass bowl designed to accelerate the process of flavouring your drinks, fresh fruits, etc. Thanks to the vacuum, you will be able to speed up the process of osmosis. Brewing the flavours in just a few minutes, even in cold infusion.

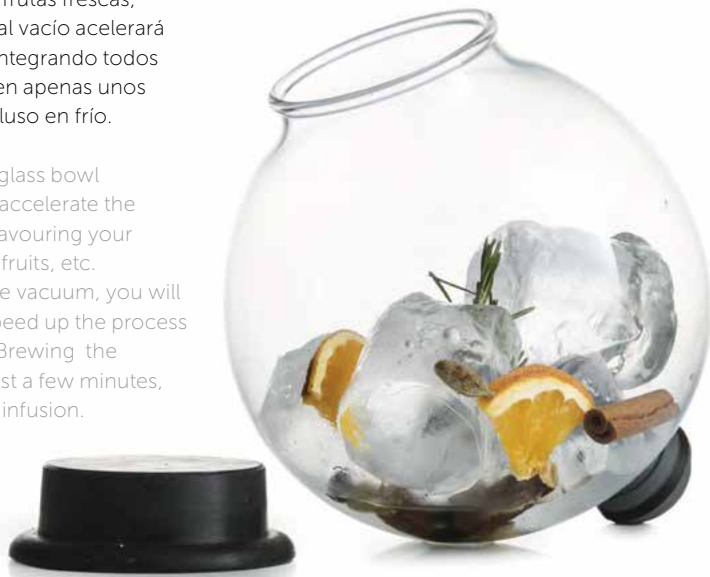

Realice el vacío con la bomba Ref. 160/0078-1 u otra bomba de extracción, incluso con una eléctrica.

Create the vacuum using our pump Ref. 160/0078-1 or another extraction pump, including electric vacuum pump.



VACUUM INFUSION  
TO ENHANCE SAVOURS

160/0078  
Infusion Bowl\*

1 L

Ø 13 cm Alt / Height: 16 cm

El kit contiene/ The kit contains:

Bowl de vidrio borosilicato  
Borosilicate Glass Bowl

Tapón soporte de silicona  
Silicone stopper support

Tapón doble de cierre  
Double sealing plug

Tapón para realizar el vacío  
One plug for vacuum

Pajita de vidrio  
One glass straw

VACUUM  
COCKTAIL  
SHAKER



EDIBLE  
COCKTAILS  
PRESENTATIONS



## BORGOÑA

160/0009 con asa / with handle

160/0010 sin asa / without handle



## DRY

160/0001 con asa / with handle

160/0002 sin asa / without handle



Ø 7,5 cm



## CHARDONNAY

160/0011 con asa / with handle

160/0012 sin asa / without handle

Más info en: / Find out more on:  
[www.100x100barman.com](http://www.100x100barman.com)

**100%Barman**

## Dry Martini "Olive" Ice Cube Stick FREEZER

Pinchos refrigerantes con forma de aceituna o cubito, para enfriar sus cockteles de forma elegante.

Rellenos de una mezcla térmica, que se congela sin provocar dilatación ni rotura del vidrio.

Cool your drinks with elegance, with our cool pinchos in shape of olive or ice cube.

The pincho is filled with a special thermal-fluid which can get freeze without to expand and break the glass.

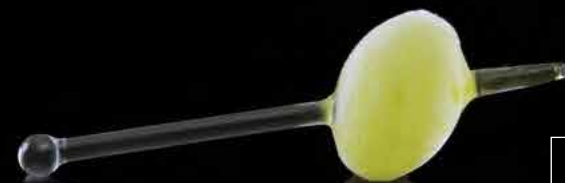

2 uds  
pcs

160/0081  
Ice Cube Stick

Largo / Long: 16 cm

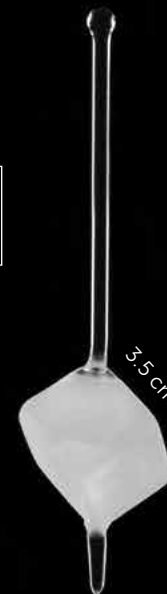

3 uds  
pcs

160/0080  
Dry Martini Freezer "Olive"

Largo / Long: 10 cm



## MIX & DRY

Juego de cuchara mezcladora  
y agitador de hielo  
Set of borosilicate bar spoon  
and dry ice stirrer

Gasifique y añada cierto glamour  
a su vaso mezclador incorporando  
niebla con hielo seco. También  
puede utilizarse como infusor  
añadiendo hierbas, pieles de cítricos,  
flores o liofilizados, dando toques  
de sabor y color a sus combinados.

Add gas and some glamour to your  
cocktail creating fog with dry ice.  
It can infuse by adding herbs, citrus  
peels, flowers, lyophilized products,  
giving touches of flavor and color to  
any cocktail.



160/0111  
Mix & Dry Kit

Largo / Long: 29 cm  
Vaso no incluido  
Glass not included



160/0110  
Vaso Gallone  
Gallon Mixing Glass

2.5 L

Vaso mezclador  
gigante especial  
eventos

For special events  
use our giant  
mixing glass

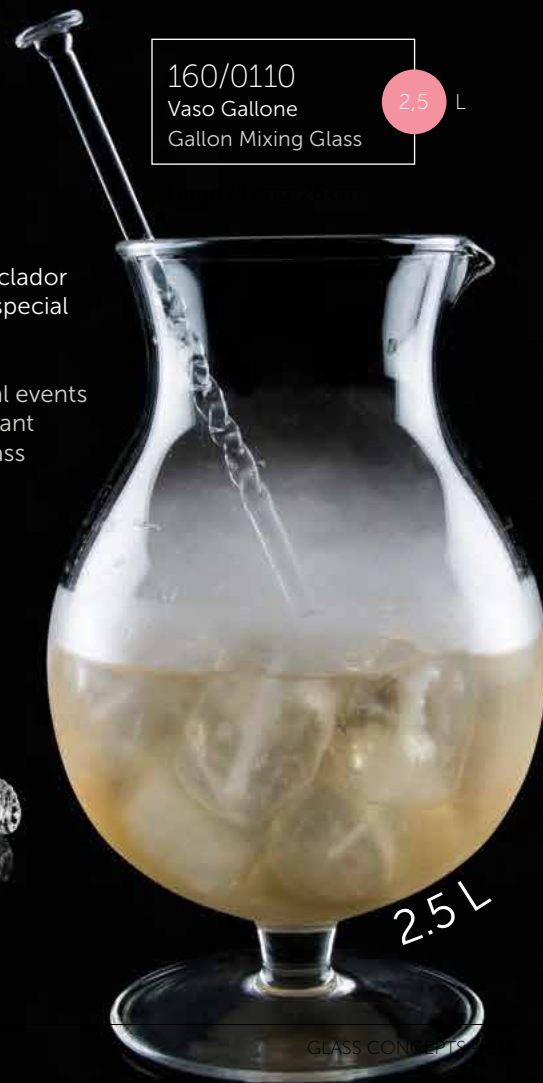

2.5 L

GLASS CONCEPTS

## LISBOA

Infusionador de vidrio borosilicato para alimentos, inspirado en las tradicionales cafeteras portuguesas. Resistente a altas temperaturas, es ideal para infusionar hierbas aromáticas, raíces y obtener caldos u otras elaboraciones directamente en la mesa a la vista del cliente. Añada un elemento coreográfico a su servicio de mesa. Fácil de utilización, las piezas de recambio están disponibles en nuestro catálogo.

Infuser for food inspired by traditional Portuguese coffee makers, made of borosilicate glass resistant to high temperatures. Use it to infuse aromatic herbs, roots and obtain broths or other elaborations directly on the table in front of the customer. Add a choreographic element to your table service. Easy to use, spare parts are available in our catalog.

TAMBIÉN PARA INFUSIONES CON DRY ICE  
ALSO FOR DRY ICE COLD INFUSIONS



30/0043  
Infusionador de sifón Lisboa  
Vacuum Brewer Lisboa

Ø 12 cm  
Alt / Height: 36 cm





## MICROLADOR / MICROLATOR

Colador con malla de acero inoxidable de 400 micras. Con una base diseñada para encajarse en vasos, copas y tazas, podrás filtra posas o residuos, realizar infusiones frías y calientes *à la minute*.

Strainer with 400-micron stainless steel mesh. With a base designed to fit into glasses, cups, and mugs, you can filter out sediment or residue and make hot or cold infusions *à la minute*.

30/0042

Microlador - Colador inox  
Microlator - Stainless steel colander

Ø 12 cm - Alt. / Height: 9 cm

## ICE BOWL



160/0004  
Ice bowl 120 ml

Ø extern. 12 cm  
Ø intern. 8,5 cm

Bol hueco fabricado en borosilicato. Permite un relleno de flores, ramas... Ideal para rellenar con agua y congelar, formando un bowl de hielo compacto para servir cualquier sopa fría, helado, tartar, o simplemente llenarlo de humo y aromatizar el plato.

Ice Bowl is a double-walled bowl made of borosilicate glass. Ideal for filling with water and freezing, forming a compact ice bowl for serving any cold soup, ice cream, shellfish salad. Its big size significantly decreases the water loss.



## SIESTA

La copa de vino tumbada fabricada en borosilicato, resiste el fuego del soplete, a fuertes cambios térmicos, al baño en nitrógeno así como a los pequeños golpes de los cubiertos.

Lying wine glass made of Borosilicate. Resists blowing torch, strong thermal changes, nitrogen bath and also slight cutlery blows.



160/0017  
Copa Siesta / Siesta glass 350 ml

22 cm x Ø 12 cm



Ø 8 cm

Visitenos en:/ Visit us at:  
100x100chef.com



## EGGS



160/0071  
EGGS \*

6 uds  
pcs

65 ml

Ø 5 cm Alt / Height: 6 cm

Acabado mate, resistente a la cocción en el horno o al baño María.  
Matte finish, resistant to oven baking and Bain-marie.

Combina con los siguientes soportes:  
Combines with the following supports:

190/0040, 190/0045, 190/0036, 190/0026, 190/0096



160/0104  
Mini tartera / Mini cake stand

Ø 12 cm  
Alt / Height: 6 cm



160/0038  
Cono glass / Glass Cone

6 uds  
pcs

75 ml

Ø 6 cm  
Alt / Height: 13 cm

## CU-CU-RU-CHO ICE CREAM CONE

¡El cucurucho tradicional  
reinventado en borosilicato!  
Resiste a la congelación.

Beautiful mini ice cream  
cones made of borosilicate.  
Resistant to freeze.



160/0030  
Cucurucho / Ice cream cone \*

4 uds  
pcs

Ø 4 cm  
Alt / Height: 10 cm

\*Soportes no incluidos / Supports not included

Botellas de cristal borosilicato, resistentes al frío del nitrógeno. Diseñadas para servir jugos, esencias o licores.

Double-layered borosilicate glass bottles. Resistant to cold nitrogen. Made for serving juices, liqueurs or spirits.

## Botella termo Thermal Bottle

160/0023 750 ml Alt / Height: 39 cm

160/0024 500 ml Alt / Height: 30 cm

Ø 8 cm



2 uds  
pcs

160/0016

Mini aceitera de cristal  
Mini oil bottle

Ø 5,5 cm Alt / Height: 13 cm



## DRY-SPOON 6 uds pcs

100/1016 SNOW

100/0016 CLEAR 11 x 2,5 cm

Cuchara individual con doble cámara, ideal para presentar combinaciones de texturas y líquidos sin contacto directo.

Single spoon with double chamber, ideal for presenting combinations of textures and liquids without direct contact.



10 ml



160/0077

Lata Alta Drink Vidrio  
Tall Drink Glass Can

450 ml

Ø 8 cm Alt / Height: 16 cm



## SPACE

Plato reversible en forma esférica transparente.  
Permite ser utilizado como bowl o plato de presentación.  
Serving plate shaped as a spheric transparent disc.  
Double face, can be used as bowl or presentation plate.

160/6001

Plato Space  
Space Plate

Ø 22 x 8 cm



160/0075

Lata redonda vidrio  
Round Glass Can

200 ml

Ø 8 cm Alt / Height: 10 cm

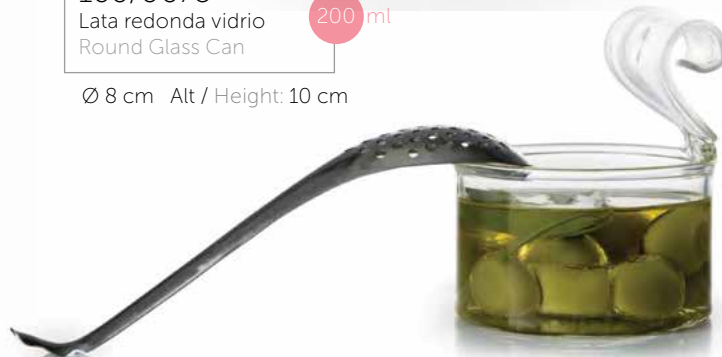

160/0076

Lata oval vidrio  
Oval Glass Can

150 ml

12 x 8 cm  
Alt / Height: 10 cm





## BRANCHE GLASS

Vaso para cocktail o destilado sobre base de madera natural de Teka. Su vaso de fino vidrio borosilicato está moldeado uno a uno a semejanza de la rama, encajando en uno de sus nudos portándole estabilidad para su transporte. Todas las ramas y vasos son diferentes tanto en tamaño y forma por lo que confiere a esta colección un carácter único y distinguido.

### LIMITED EDITION!

Glass for cocktail or liqueurs placed on a natural Teka wood base. Its fine borosilicate glass is molded individually following the shape of the branch, fitting into one of its knots to ensure the stability while serving. All branches and vessels are different in both size and shape, giving this collection an unique and exclusive feature.



160/0123  
Branche Glas

6  
uds  
pcs

Ø 22 cm Alt / Height: 11 cm



Caja de madera con cubeta de metacrilato color blanco especialmente diseñada para presentar platos con nieblas de hielo seco. Su cristal superior tiene un agujero lateral para que la niebla quede en la parte superior del plato creando un efecto "bosque".

Wood box with white methacrylate bucket specially designed to present dishes with dry ice fog. The space between the glass tray and the box lets the fog escape from the sides, creating a forest mist effect.



PC/50020

Caja Corfú  
Corfu box

21 x 13 cm  
Altura / Height: 7 cm

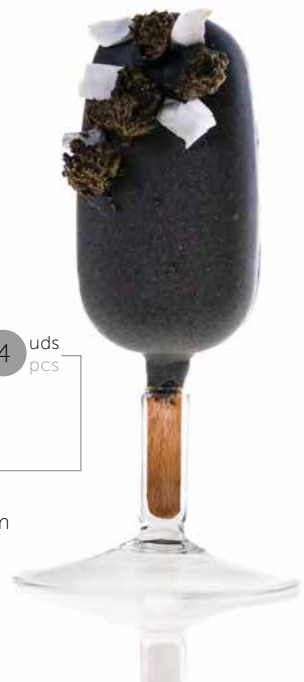

4 uds  
pcs

160/5046  
Soporte Polo  
Popsicle Base

Ø 8 cm  
Alt / Height: 6 cm

PC/50018

Caja Skiathos  
Skiathos box

25 x 18 cm  
Altura / Height: 7 cm



Efecto Bosque  
Forest Effect

# Ovni Tapa

Plato Ovni Tapa, perfecto para presentar cualquier snack o petit four usando nitrógeno, hielo seco combinado con aromas o platos con ahumado, etc.

Plato parte superior | Ø 14 cm  
Top plate

Ovni Tapas dish: perfect for any snack or petit four using nitrogen, or dry ice combined with spices, smoked dishes.

Bol parte inferior | Ø 8 cm  
Bottom bowl



Personalización de tamaño  
Fabricación bajo pedido

Size customization  
Made upon order

160/0025  
OVNI Tapa

2 uds  
pcs

90 ml



BOROSILICATO

**Ovni**

Plato presentación OVNI, perfecto para presentaciones con hielo seco combinado con aromas, platos con ahumado.

UFO presentation plate, perfect for presenting any creation using dry ice combined with spices, smoked dishes.



Personalización de tamaño  
Fabricación bajo pedido

Size customization  
Made upon order



BOROSILICATO

160/0005 XS  
OVNI

Ø 23 cm

160/0006 XL  
OVNI

Ø 28 cm





GLASS CONCEPTS AT:  
www.100x100chef.com

## VULCANO

Plato para ser utilizado con fuego en su interior, perfecto para presentaciones usando el fuego como elemento central.

Gratine unas piezas con caramelo, caliente una copa de cognac o improvise una pequeña cocina en la mesa para saltear unas fresas en la Paella de vidrio ref. 160/0028.

Plate with cavity for fire in the middle. Perfect for presenting any dish using fire as a centerpiece of the plate.

Use for caramel-coating, heating a glass of cognac or transform it into portable table stove where you can toss some strawberries in our glass paella pan, ref. 160/0028.



Personalización de tamaño  
Fabricación bajo pedido

Size customization  
Made upon order



BOROSILICATO

160/0026  
Vulcano Plate XS

Ø 23 cm

160/0027  
Vulcano Plate XL

Ø 28 cm

160/0028  
Paella borosilicato  
Borosilicate Pan

Ø 20 cm





160/0039

Ice Age Plate S

Ø 13/14 cm



160/0040

Ice Age Plate M

Ø 16/17 cm



160/0041

Ice Age Plate L

Ø 20/21 cm



160/0072

Ice Age Lemon

24 x 10 cm



160/0099

Ice Age Plate XL

Ø 25/26 cm

160/0100

Ice Age Plate XXL

Ø 28/30 cm

## ICE AGE

Soportes de presentación o vasos termo fabricados en cristal satinado, ideales para congelar sin esfuerzo ni roturas. Rellenos con una mezcla térmica que se congela sin provocar dilatación ni roturas, podrá servir su plato o bebida con forma de hielo, totalmente compacto y sin generar deshielo o pérdida de agua, y servir cualquier marisco, helado, tartar o licor.

Unique in the market, the Ice Age Plate series has the versatility to meet any serving need. Made with satin glass, it withstands extremely low temperatures without dilatation or breakage due to the thermal mix and the resistance of the glass walls. Serve and keep chilled any dish from seafood, to ice cream or tartare without defrosting or water spilling.

160/1004  
Ice bowl FREEZER

120 ml

Ø 12 cm / Ø 8,5 cm





Fabricados artesanalmente en borosilicato  
Handcrafted with borosilicate in Spain

160/0062  
Chupito FREEZER  
FREEZER Shot Glass

75 ml

Ø 5 cm  
Alt / Height: 12 cm



160/0112  
Iceberg XS

Ø 12 cm  
Alt / Height: 4 cm



160/0114  
Iceberg XL

Ø 14 cm  
Alt / Height: 7 cm



160/0061  
Dry FREEZER Glass

150 ml

Ø 9 cm  
Alt / Height: 12 cm





240/0079  
Lago Paradiso M

3 uds  
pcs

Ø 22 cm cm Alt/H: 5 cm



240/0078  
Lago Paradiso S

3 uds  
pcs

Ø 16 cm Alt/H: 5 cm



240/0083  
Azteca Grande

3 uds  
pcs

Ø 22 cm cm Alt/H: 3,5 cm



240/0081  
Azteca Bowl

3 uds  
pcs

Ø 17 cm Alt/H: 2,5 cm



240/0080  
Azteca Pan

3 uds  
pcs

Ø 10 cm Alt/H: 2,5 cm



240/0084  
Azteca Snack

3 uds  
pcs

12 x 13 Alt/H: 2 cm



240/0082  
Azteca Moon  
Azteca Luna

3 uds  
pcs

Ø 19 cm Alt/H: 1 cm

## AZTECA

Inspirada en las ofrendas y metales sagrados de los aztecas, la colección Azteca transforma la luz en materia. Sus reflejos irisados evocan el misterio y la fuerza de una civilización que encontraba lo divino en cada detalle.

Drawing inspiration from the sacred offerings and metals of the Aztecs, the Azteca collection captures the essence of light. Its iridescent reflections evoke the mystery and strength of a civilisation that saw divinity in everything.

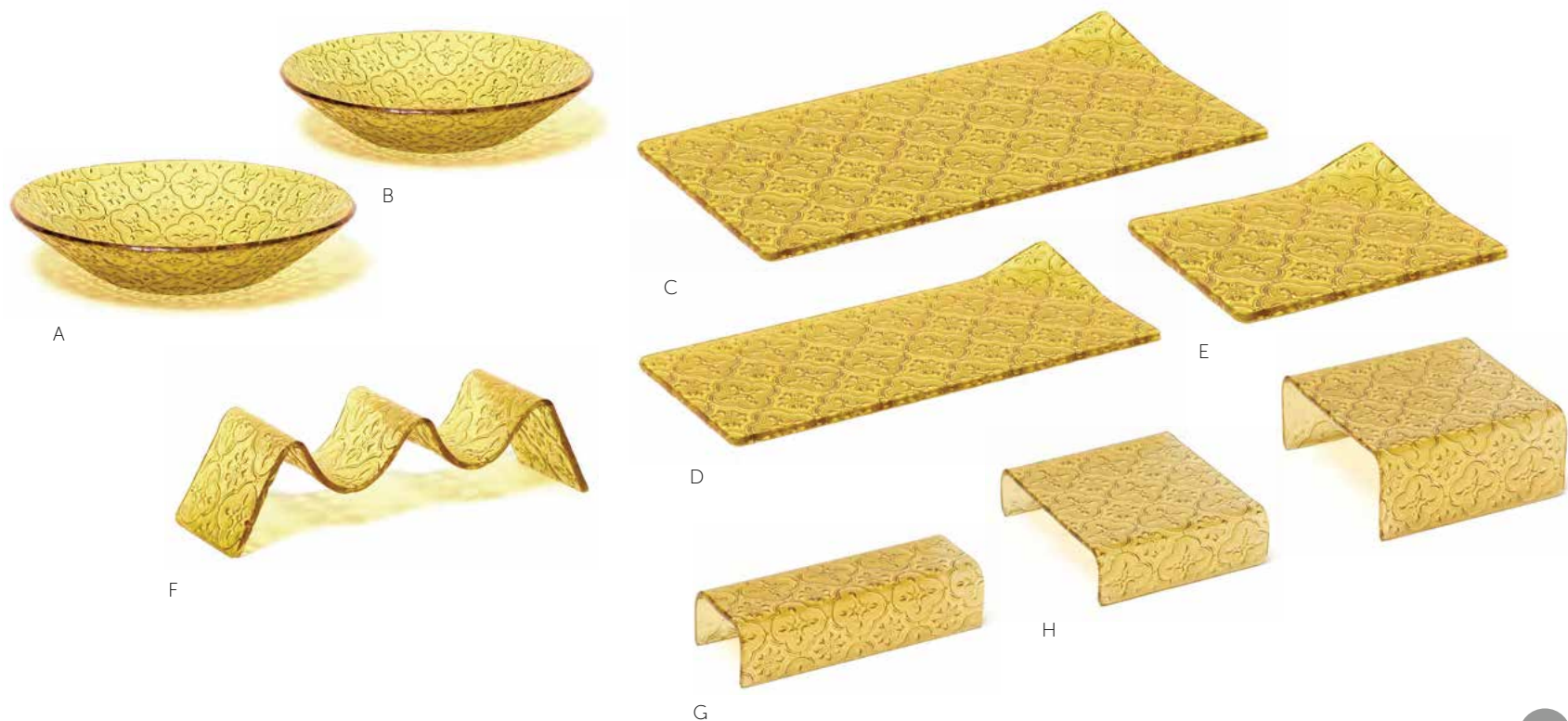

Texturas ámbar / Amber textures

4 uds  
pcs

A	160/7000	Bol Ø 19 / Ø 19 bowl	D	160/7003	Plato M / M plate	12 x 24 cm	G	160/7006	Soporte snacks mini / Mini snack tray	15 x 5 x 3,5 cm	
B	160/7001	Bol Ø 15 / Ø 15 bowl	E	160/7004	Plato S / S plate	12 x 12 cm	H	160/7007	Soporte snacks cuadrado bajo / Low square snack holder	12 x 10,5 x 3 cm	
C	160/7002	Plato L / L plate	27 x 17 cm	F	160/7005	Soporte taco doble / Double taco stand	18 x 5 x 6 cm	I	160/7008	Soporte snacks cuadrado alto / Tall square snack holder	11,5 x 11,5 x 5 cm



Texturas ámbar / Amber textures

J	160/7009	Soporte snacks rectangular bajo / Low rectangular snack holder	21 x 6 x 2,8 cm	M	160/7012	Plato redondo M / M round plate	Ø18 cm
K	160/7010	Soporte snacks rectangular alto / Tall rectangular snack holder	21 x 9 x 4,5 cm	N	160/7013	Plato redondo L / L round plate	Ø22 cm
L	160/7011	Plato redondo S / S round plate	Ø14 cm	O	160/7014	Soporte redondo 3 patas / 3 feet round stand	Ø14 cm

4 uds  
pcs



240/0045

Tableta chocolate negro  
Black chocolate bar

25 x 13 cm  
Alt / Height: 2 cm



240/0046

Tableta chocolate blanco  
White chocolate bar

25 x 13 cm  
Alt / Height: 2 cm

240/0047

Plato chocolatina negra  
Black chocolate snack plate

18 x 13 cm  
Alt / Height: 3 cm



240/0048

Plato chocolatina blanca  
White chocolate snack plate

18 x 13 cm  
Alt / Height: 3 cm





ZIG ZAG 21 x 9 x 1.5 cm

240/0029 Blanco / White

240/0030 Negro / Black

240/0031  
NAPKIN  
Blanco / White

22 x 18 x 2 cm



240/0032  
NAPKIN  
Negro / Black

22 x 18 x 2 cm





240/0025  
BOILING XL  
Blanco / White

Ø 26 x 2 cm



240/0026  
BOILING XS  
Blanco / White

Ø 20 x 2 cm

OVAL Blanco / White

240/0033 XL 30 x 12 x 2 cm

240/0034 XS 19 x 11 x 2 cm



Minimiza  
el ruido de los cubiertos

OVAL Negro / Black

240/0035 XL 30 x 12 x 2 cm

240/0036 XS 19 x 11 x 2 cm



Cutlery Sound Reducer

## LAVA, BOILING & MORE

Platos y bandejas fabricados con vidrio Opal mediante la técnica de moldeo por fusión. Disponibles en color negro o blanco con textura suave mate. Ideal para resaltar elaboraciones de colores intensos.

A pesar de su ligereza, ofrecen gran resistencia al trabajo diario.

Dishes and trays made of Opal glass, using the fusing moulding technique. Available in black or white, with a smooth matt or glossy texture depending on the model. Ideal for highlighting elaborations of intense colours.

Despite their lightness, they offer great resistance to daily work.



240/0028  
BOILING XS  
Negro / Black

Ø 20 x 2 cm



240/0027  
BOILING XL  
Negro / Black

Ø 26 x 2 cm

## BAMBOO

Platos ligeros cómo el vidrio,  
y elegantes como esculturas

Dishes as light as glass,  
and elegant as sculptures

240/0056  
Plato Bambú  
Bamboo Plate

26 x 9 cm  
Alt / Height: 4 cm



## MADREPERLA

Platos de vidrio  
con acabado nácar

Glass plates with  
pearl finish

240/2004  
Pearl plate

14 x 14 cm

2 uds  
pcs



240/2003  
Pearl bowl

Ø 12 cm

2 uds  
pcs



240/3001

LAVA  
Plato hondo / Soup plate

Ø 22 cm



240/3002

LAVA XS

Ø 17 cm



## BLUE CARIBBEAN & WAKAME

240/0019  
Wakame Plate S

2 uds  
pcs

Ø 17 cm

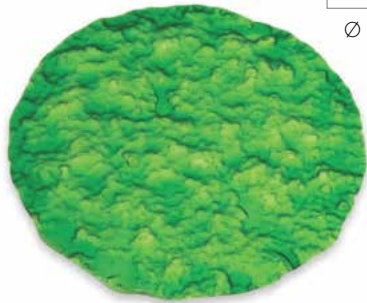

240/1018  
Blue Caribbean M

2 uds  
pcs

Ø 24 cm



240/1019  
Blue Caribbean S

2 uds  
pcs

Ø 17 cm

240/1017  
Blue Caribbean L

Ø 29 cm

Fabricados con vidrio Opal mediante la técnica de moldeado por fusión. Acabados mates y aterciopelados. Gran resistencia al trabajo diario a pesar de su ligereza, tan sólo 400 g.



STUCCO NEGRO  
BLACK STUCCO

240/0004  
Stucco negro  
Black Stucco

Ø 27 cm

Made with Opal glass, using fusion moulding technique. Matte and velvety finish with minimalist design. Plates highly resistant to daily work, despite their light weight of only 400 g.

## CUCHARAS DEGUSTACIÓN PRESENTATION SPOONS

Pétalos de rosa moldeados en vidrio coloreado. Sutiles, ligeros y elegantes, no requieren el uso de cubiertos.

Rose petals moulded in coloured glass. Subtle, light and elegant, they do not require the use of cutlery.



ROSES **6** uds  
pcs

240/0014 Rojo / Red

240/0015 Blanco / White

240/0016 Rosado / Rosy

7 x 5 cm Alt / Height: 3 cm

2 uds  
pcs

240/0074  
Hikamura L

18 x 11 cm Alt / Height: 2 cm



2 uds  
pcs

240/0073  
Hikamura S

18 x 6 cm Alt / Height: 2 cm



240/0076  
Bandeja 2 ostras  
2 Oysters tray

18 x 13 cm Alt / Height: 3 cm



240/0072  
Bandeja 6 ostras  
6 Oysters tray

Ø 26 cm Alt / Height: 4 cm



240/0071  
Bandeja 12 ostras  
12 Oysters tray

Ø 38 cm Alt / Height: 4 cm



De vidrio transparente para rellenar con hielo pilé. Son apilables y reversibles para otros tipos de presentaciones. No gotean ni mojan el mantel.

Clear glass trays for filling with crushed ice. They are stackable and reversible for other types of presentations. Do not drip or wet the tablecloth.

## CADAQUÉS

Platos de vidrio diseñados por el mar

Glass plates shaped by the sea



	XXS 9 x 7 cm	XS 14 x 10 cm	XL 22 x 14 cm	XXL 25 x 20 cm
	4 uds pcs	2 uds pcs	2 uds pcs	1 uds pcs
Azul / Blue	240/0068	240/0010	240/0006	240/0062
Verde / Green	240/0069	240/0011	240/0007	240/0063
Blanco / White	240/0070	240/0012	240/0008	240/0064

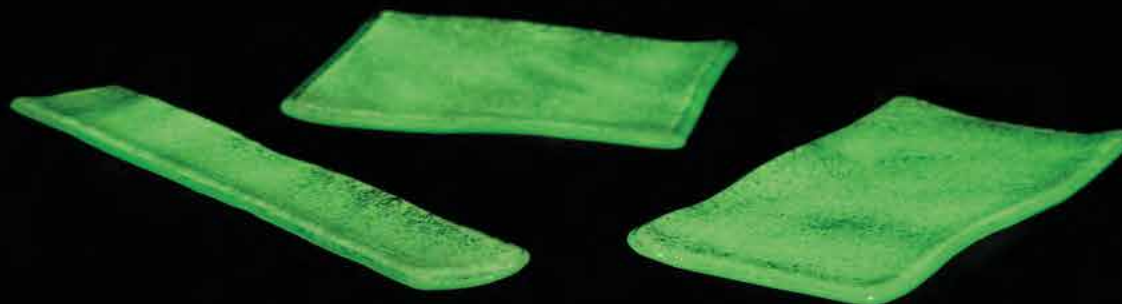

**FLUORESCENT**

## PHOSPHORUS

Exclusive glass plates filled with fluorite. Transform your table into a dreamlike stage with the fluorescent effect these plates provide. After a brief exposure to light, either natural or artificial, these plates will come to life under subdued lighting, creating a dazzling glow that lasts for minutes. The best part is, you don't need ultraviolet or blacklight to enjoy this fascinating experience.

### PHOSPHORUS 3 uds pcs

240/0065	Peti	5,5 x 30 cm Alt / Height: 1 cm
240/0066	Plato / Plate	18 x 18 cm Alt / Height: 1 cm
240/0067	Bandeja / Tray	12 x 26 cm Alt / Height: 1 cm

## PHOSPHORUS

Exclusivos platos de vidrio con relleno de fluorita. Convierta su mesa en un escenario de ensueño con el efecto fluorescente que estos platos ofrecen. Después de una breve exposición a la luz, ya sea natural o artificial, estos platos cobrarán vida bajo una iluminación tenue, creando un deslumbrante resplandor propio que durará minutos. Lo mejor de todo es que no se requiere luz ultravioleta o negra para disfrutar de esta experiencia fascinante.

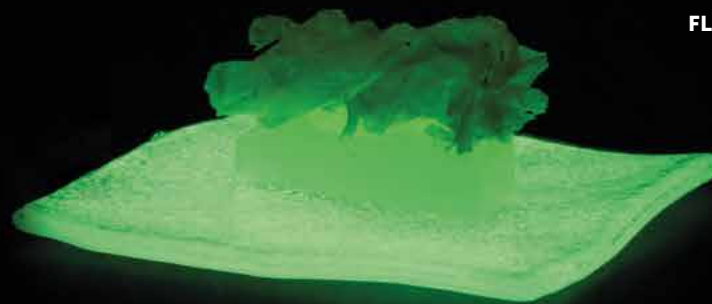

**FLUORESCENTE**

## SLASHED

Medias botellas con el corte pulido y base rebajada que le confiere una buena estabilidad.

Ideal para presentar platos o postres con vino, cava o licor como ingrediente.

Half bottles with polished cut and lowered base that gives it good stability.

Ideal for presenting dishes or desserts with champagne, wine or liquor as ingredient.



6 uds pcs  
100/0140  
Plato hondo cava verde\*  
Deep Champagne Plate Green\*  
500 ml

30 x 8 cm - Alt / Height: 6 cm



2 uds pcs  
100/0188  
Vaso cocktail cava  
Cocktail glass cava  
330 ml

Ø7 cm - Alt / Height: 18 cm



6 uds pcs  
100/0049  
Plato botella cava  
Champagne Plate  
250 ml

30 x 8 cm - Alt / Height: 4 cm

6 uds pcs  
100/0088  
Plato botella cava MINI  
MINI Champagne Plate  
130 ml

24 x 7 cm - Alt / Height: 4 cm



3 uds pcs  
100/0190  
Plato cava para corcho  
Cava cork plate

15 x 6 cm Alt / Height: 2 cm

3 uds pcs  
100/0189  
Plato cava snack  
Snack cava plate

19 x 7 cm Alt / Height: 2 cm



100/0191

Plato botella anis  
Anisette bottle plate

6 uds  
pcs

300 ml

30 x 8 cm Alt / Height: 4 cm



# ad\ance collection

“Mise-en-scène” de platos  
gastronómicos  
Mise en scène for gastronomic  
masterpieces

Consiste en un soporte transparente (escenario) y un plato acoplable disponible en diferentes modelos. La base se utiliza como escenario donde ambientar la creación del Chef, combinando con cada plato un escenario con naturaleza viva, hojas secas, flores, hierbas aromáticas... Aporte aromas y efectos visuales como niebla de hielo seco, humo o luz. Un mismo escenario puede ofrecer infinitas posibilidades a la hora de presentar cada plato, dependiendo de la imaginación de cada profesional.

A transparent support is the stage that holds a presentation plate available in different models. The glass base is used as a scene where the Chef's creation reveals, marrying each dish with vivid nature, dry leaves, flowers or aromatic herbs. Add scents and visual effects such as dry ice fog, smoke and light. One scenario turns into infinite possibilities when presenting each dish, depending on your imagination.



Fabricado artesanalmente en borosilicato  
Borosilicate handcrafted in Spain

160/0125  
Advance Escenario  
Advance Stage

Ø 28 cm  
Alt / Height: 8.5 cm





BLACK MOON



GALAXY



VENUS



## ADVANCE

PLATOS DE MÁRMOL / MARBLE PLATES

190/0083

Black Moon

190/0084

Galaxy

190/0085

Venus

Ø 17 cm

Personalice sus platos tanto en tipo de mármol como diseño  
Customize your plates in both marble type and design

## ADVANCE

PLATOS DE VIDRIO OPAL / OPAL GLASS PLATES

240/0021

Pearl

240/0022

Tiger's Eyes

3 uds  
pcs

240/0023

Emerald

240/0024

Obsidian

Ø 17 cm



PEARL



TIGER'S EYES

EMERALD



OBSIDIAN



## ADVANCE R-FILL

Le hemos dado la vuelta a nuestros platos Advance. ¡Literalmente!  
Esta nueva versión cuenta con la base y orificio de llenado bajo el plato, permitiendo el emplatado directamente sobre el cristal. Conseguimos una integración visual perfecta entre el plato y el relleno elegido.

We have turned our Advance plates upside down. Literally!  
This new version features a base and filling hole beneath the plate, allowing direct plating onto the glass. We achieve a perfect visual integration between the plate and the chosen filling.



150 ml

160/5096

R-fill Bowl

Ø 14 cm Alt / Height: 8 cm

160/5076

R-fill Glass

Ø 14 cm Alt / Height: 12 cm



300 ml

HOW TO USE R-FILL?



CORCHO R-FILL / R-FILL CORK

160/5105	Big (160/5074 - 160/5075)	Ø 9,8 cm
160/5106	Small (160/5096 - 160/5076)	Ø 7,5 cm



160/5074  
R-fill Deep  
Ø 25 cm  
Alt / Height: 10,5 cm



160/5075  
R-fill Plate  
Ø 22,5 cm  
Alt / Height: 5,5 cm



1 Corcho incluido en la compra de cada plato, vaso o bowl.  
1 Cork included with the purchase of each plate, glass, or bowl.

*"Más allá de la realidad"*

*"Beyond reality"*





# Poliplate

Poliplate es la colección de resina ligera y resistente con detalles realistas y divertidos que permiten presentaciones sorprendentes.

Sus formas y tamaños permiten el servicio de comida y bebida personalizado sea cual sea la ocasión.

Poliplate is a lightweight, durable resin with realistic and fun details, allowing for striking presentations.

Its range of shapes and sizes makes it ideal for personalised food and drink service, no matter the occasion.

300/0040  
Bandeja Chumbrera  
Chumbrera tray

39,5 x 23,5 Altura / Height: 9,5 cm



300/0032  
Vaso Dessert  
Dessert Glass

300 ml

16 x 9 Altura / Height: 18,5 cm  
Incluye vaso  
Glass is included

300/0033  
Vaso Carnivore  
Carnivore Glass

270 ml

Ø 12 Altura / Height: 13 cm  
Vaso y luz LED incluidos  
Glass and LED light are included





Novedades y cuidados  
Novelties & care instructions

100%Lab

300/0034  
Plato patata  
Plate Potato

9 x 13 Altura / Height: 6 cm



300/0035  
Vaso resina Moai gris  
Moai grey resin glass

270 ml

8,5 x 11,5 Altura / Height: 18,5 cm  
Vaso incluido / Glass is included



300/0037  
Vaso resina Moai marrón  
Moai brown resin glass

270 ml

8,5 x 11,5 Altura / Height: 18,5 cm  
Vaso incluido / Glass is included





300/0038  
Seashell

26 x 17 cm Altura / Height: 13 cm



## Seashell

Con su diseño envolvente y orgánico es ideal para presentar pequeños bocados marinos con un toque escenográfico que no pasa desapercibido.

Al igual que toda la colección Poliplate, cuenta con pinturas y esmaltes certificados y se debe lavar a mano y con productos no abrasivos.

Thanks to its enveloping, organic design, it is perfect for serving small seafood dishes and making a striking visual impression.

Like the rest of the Poliplate collection, it is made using certified paints and glazes, and should be washed by hand using non-abrasive products.

## Lobster tray

Trae el mar a la mesa con esta bandeja de resina diseñada en forma de pinza de bogavante.

Incluye una rejilla (41x20,5 cm) inox. desmontable y encajable que facilita el drenaje del hielo y mantiene el producto en perfectas condiciones de servicio.

Bring the sea to the table with this resin tray designed in the shape of a lobster claw.

It includes a removable, stackable stainless steel grid (41x20.5 cm) that facilitates ice drainage and keeps the product in perfect serving condition.

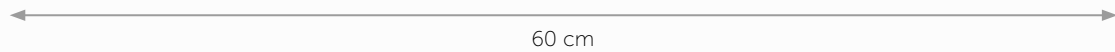

60 cm

300/0041  
Lobster tray

60 x 32 cm Altura / Height: 9 cm



# TropiCups

300/0012

PLÁTANO / BANANA

120 ml

16 X 17 cm

Altura / Height: 19 cm



300/0013

FRESA / STRAWBERRY

300 ml

Ø 13 cm Altura / Height: 18 cm





300/0014  
PIÑA / PINEAPPLE

300 ml

Ø 11 cm Altura / Height: 18 cm



300/0015  
MORA / BLACKBERRY

300 ml

Ø 13 cm Altura / Height: 18 cm

## HIPERREALISMO HYPERREALISM

Piezas originales, íntegramente fabricadas en resina y pintadas a mano con pinturas aptas al contacto alimentario. Resistentes a golpes, desconches y desgaste. Moldes personalizables, exclusivos a demanda y en pequeñas series.

Original pieces with unique design. Thermoformed with acrylic resin: a low-density and light material. Super-resistant and salt-proof. Moulds that can be customised, unrepeatable on demand and in small series.



300/0031  
Baya cacao oro  
Gold cocoa bean

26 x 12 cm  
Altura / Height: 11 cm



300/0027  
Helado nata  
Icecream Sandwich

20 x 10 cm  
Altura / Height: 6 cm



300/0028  
Baya cacao  
Cocoa bean

26 x 12 cm  
Altura / Height: 11 cm



300/0027  
Grano de café  
Coffe bean

19 x 11 cm  
Altura / Height: 7 cm



PERSONALIZABLES  
CUSTOMIZABLES

a partir de 15 uds  
from 15 pcs

Cada pieza se puede producir en diferentes colores según demanda.

All shapes are customizable in different colors.



## PORKY SILVER

300/0007 22 x 10 cm - Altura / Height: 9 cm

300/0022 38 x 18 cm - Altura / Height: 15 cm



300/0023  
Bandeja Porky Rosa  
Pink Porky Tray

48 x 20 cm  
Altura / Height: 18 cm



300/0030  
Lingote oro  
Gold ingot

21 x 10 cm  
Altura / Height: 5 cm





## BOWL TOMATO

300/0019 Verde · Green

300/0020 Rojo · Red

Ø 12 cm

Altura / Height: 12 cm 250 ml

300/0017  
Soporte taco maíz  
Corn Taco Support

27 x 9 cm

Altura / Height: 7 cm

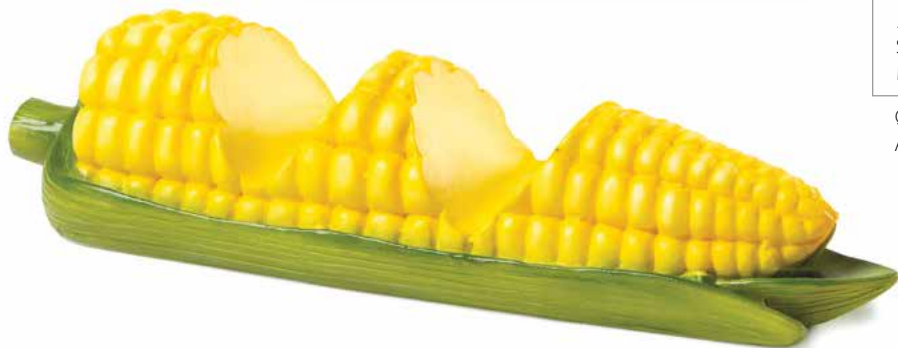

300/0018

Bowl manzana roja  
Red Apple Bowl

250 ml

Ø 12 cm

Altura / Height: 12 cm



300/0021  
Bowl naranja  
Orange Bowl

250 ml

13 x 12 cm

Altura / Height: 13 cm

300/0024

Soporte taco mex  
Mex Taco Support

Ø 13.5 cm

Altura / Height: 5.5 cm



300/0009  
OCTOPUS SLICE

Ø 24 cm  
Altura / Height: 5 cm



300/0001  
BOGAVANTE / LOBSTER

35 x 20 cm  
Altura / Height: 6 cm



300/0016  
Soporte hoja pez  
Fish Leaf Support

34 x 8 cm  
Altura / Height: 6 cm



300/0011  
TUNA VERTEBRA

21 x 8 cm  
Altura / Height: 6 cm



300/0004  
Hoja verde primavera  
Leaf Spring Green

19 x 14 cm Alt / Height: 3 cm



300/0005  
Hoja roja otoño  
Leaf Fall Red

19 x 14 cm Alt / Height: 3 cm

300/0025  
POTATO BOWL

500 ml

20 x 15 cm  
Altura / Height: 10 cm



300/0010  
SERVILLETA / NAPKIN BOWL

13 x 13 cm  
Altura / Height: 7 cm



300/0002  
CHOCOLAT PLATE

Ø ex.10 cm - Ø int.9 cm  
Altura / Height: 12 cm



300/0006  
MILK SPLASH PLATE

11 x 11 cm  
Altura / Height: 8 cm  
Ø int. 5 cm



300/0029  
LEMON SORBET

240 ml

Ø 10 cm  
Altura / Height: 11 cm



Posibilidad de etiqueta personalizada  
Option to add a custom label



300/0003  
COCO LOCO CUP

250 ml

Ø 10 cm  
Altura / Height: 13 cm



*"Practicidad y estilo profesional para realizar presentaciones en eventos y servicios gastronómicos"*  
*"Practicality and professional style to enhance presentations in events and gastronomic services"*



## TABLE TOP

EMPLATADO Y CUBERTERÍA /  
PLATING AND CUTERLY ..... 367

BENDEJAS Y CÁTERING /  
TRAYS AND CATERING ..... 399

# KODAI



For a ritual with personality that transports us to the Asian world. Kodai is a cutlery with original design and quality to complete the most creative dishes. With a sophisticated finish, it features a distinct piece for each dish.  
Made in Stainless Steel 18% Nickel Free / 3 mm / Vintage Finish

Para un ritual con personalidad que nos transporta al mundo asiático. Kodai es una cubertería con diseño original y de calidad para completar los emplatados más creativos.  
De acabado sofisticado, dispone de una pieza distinta para cada plato.  
Realizada en Inox 18% Nickel Free / 3 mm / Acabado Vintage



2019 WINNER  
**EUROPEAN  
PRODUCT  
DESIGN  
AWARD**

## KODAI VINTAGE GOLD



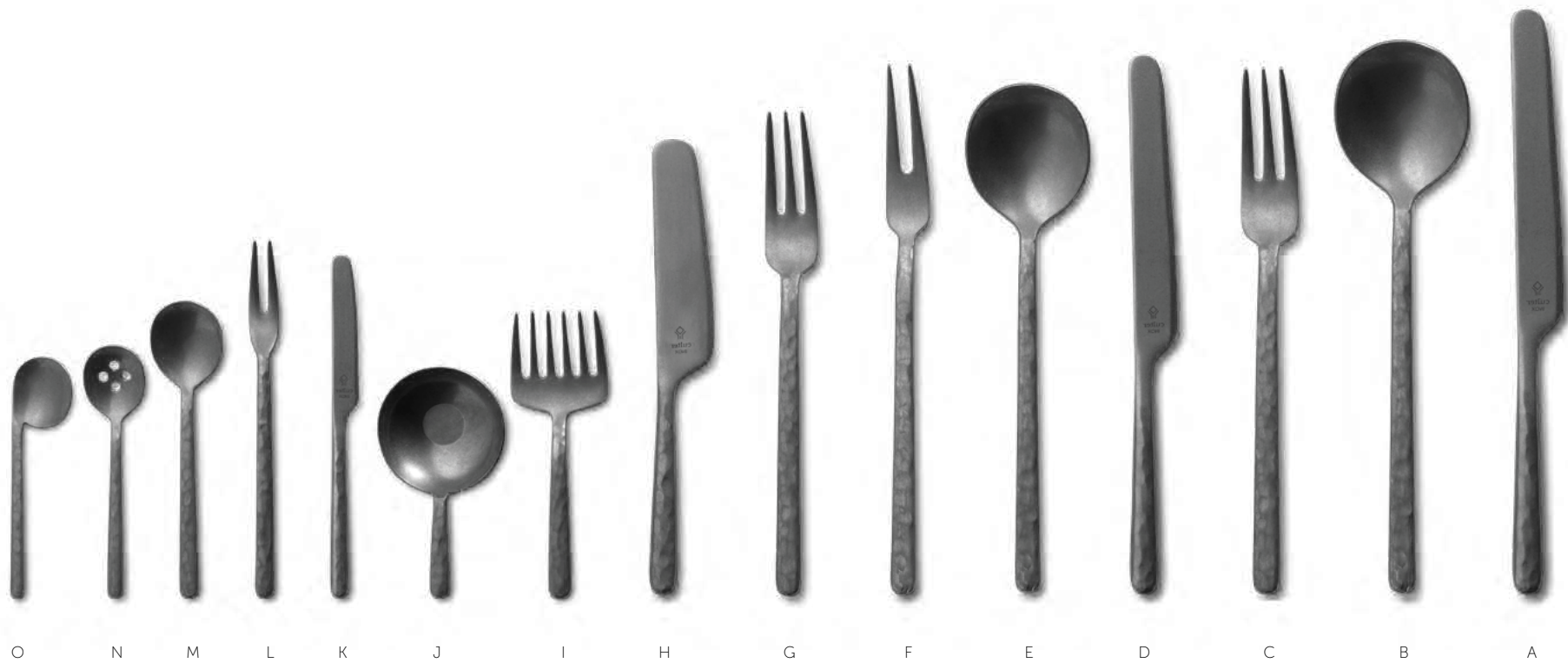

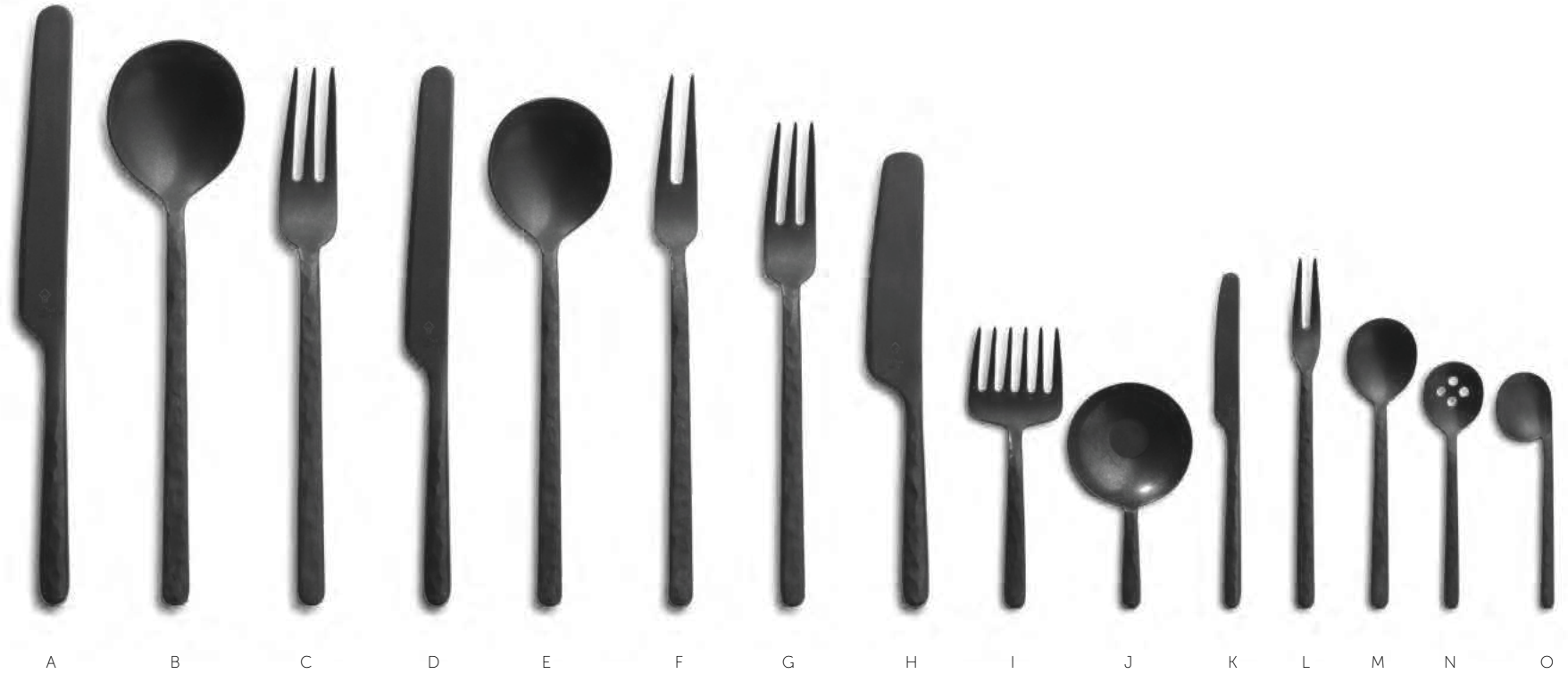

## KODAI



	GOLD	VINTAGE	BLACK		◆cm	✂cm
A	C7278	C7276	C7277	Cuchillo mesa XL / Table knife XL	21.2	0.6
B	C7281	C7279	C7280	Cuchara mesa XL / Table spoon XL	19	0.3
C	C7287	C7285	C7286	Tenedor mesa 3 puas XL / Table fork 3 prongs XL	19.5	0.3
D	C7081	C6943	C7069	Cuchillo mesa / Table knife	18.3	0.6
E	C7082	C6944	C7070	Cuchara mesa / Table spoon	17	0.25
F	C7083	C6945	C7071	Tenedor mesa 2 puas / Table fork 2 prongs	17.9	0.25
G	C7084	C6946	C7072	Tenedor mesa 3 puas / Table fork 3 prongs	16.3	0.25
H	C7085	C6947	C7073	Cuchillo mantequilla / Butter knife	15.5	0.6
I	C7092	C6954	C7080	Tenedor rastrillo / Wide fork	11.3	0.25
J	C7091	C6953	C7079	Cuchara arroz / Rice spoon	9	0.25
K	C7086	C6948	C7074	Cuchillo lunch / Cake knife	13.3	0.6
L	C7087	C6949	C7075	Tenedor lunch / Cake fork	13.8	0.2
M	C7088	C6950	C7076	Cuchara café / Coffee spoon	11.54	0.17
N	C7090	C6952	C7078	Cuchara moka / Moka spoon	9.75	0.17
O	C7089	C6951	C7077	Cuchara side / Side spoon	9.35	0.2

60 uds  
pcs

## MINI KODAI Porcelana MINI KODAI Porcelain

Experience the elegance and durability of Mini Kodai's white matte porcelain miniatures, designed to perfectly match the cutlery in the same collection. It's the perfect tableware for serving appetizers and tapas.

The porcelain used by Mini Kodai has been specially crafted to withstand heavy use. By firing it in two stages at temperatures above 1200°C, we've created a material that's both ultra-resistant and smooth to the touch.

Descubre la elegancia y durabilidad de las miniaturas de porcelana blanco mate de Mini Kodai, diseñadas a la perfección para complementar la cubertería de la misma colección. La vajilla perfecta para servir aperitivos y tapas.

La porcelana de Mini Kodai ha sido especialmente elaborada para soportar un uso intenso. Gracias a un proceso de cocción de dos tiempos a más de 1200°C, hemos creado un material ultra resistente y suave al tacto



Mini caja  
Mini box

C7622 S 6 x 6 cm - Altura / Height: 5.5 cm  
C7621 M 8 x 12 cm - Altura / Height: 7 cm

6 uds  
pcs



C7623  
Mini colador  
Mini colander

6 uds  
pcs  
Ø 10 cm  
Altura / Height: 6 cm



C7624  
Mini parrilla  
Mini grill plate

6 uds  
pcs  
Ø 9 cm  
Altura / Height: 2 cm



C7629  
Mini bandeja  
Mini tray

8 x 15.5 cm  
Altura / Height: 1 cm  
6 uds  
pcs





C7625

Mini vaso  
Mini cup

Ø 5 cm  
Alt / Height: 4 cm

6 uds  
pcs



C7626

Mini tarrina  
Mini ramekin

Ø 8 cm  
Alt / Height: 2.5 cm

6 uds  
pcs



C7627

Mini sartén  
Mini pan

Ø 9 cm  
Alt / Height: 2.5 cm  
Longitud / Large: 14 cm

6 uds  
pcs



C7628

Mini cazuela  
Mini gratin plate

Ø 9 cm  
Alt / Height: 2.5 cm  
Longitud / Large: 14 cm

6 uds  
pcs

250 ml



C7630

Mini olla  
Mini soup tureen

Ø 10 cm  
Alt / Height: 9 cm  
Longitud / Large: 14 cm

6 uds  
pcs



## LAB

Discover our collection of cutlery with pure and minimalist lines. It's perfect for accompanying appetizers, tapas, mocktails, and rice dishes!

It's made of 18/10 stainless steel, ensuring its quality and durability. LAB has multiple pieces, making it a versatile and elegant choice for any type of event. Available in 4 finishes.

Descubre nuestra colección de cubertería con líneas puras y minimalistas. ¡Es perfecta para acompañar aperitivos, tapas, mocktails, arroces...!

Fabricada en acero inoxidable 18/10, lo que garantiza su calidad y durabilidad. LAB cuenta con múltiples piezas, convirtiéndose en una elección versátil para cualquier tipo de evento. Disponible en 4 acabados.



## LAB MIRROR

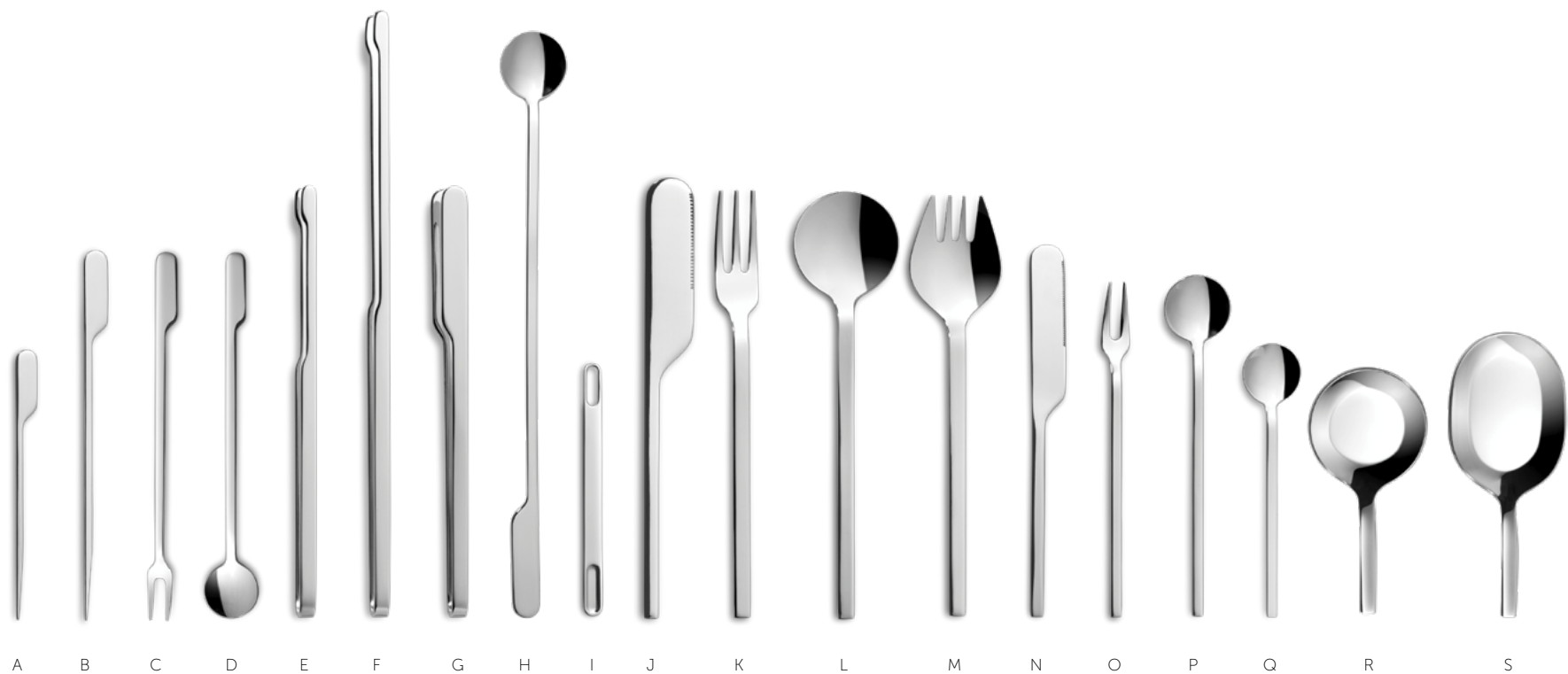

## LAB MIRROR



reddot design award  
winner 2020

2019 WINNER  
EUROPEAN  
PRODUCT  
DESIGN  
AWARD

			↕ cm	↘ cm	
A	C6980	Pincho / Mocktail stick	10	0.2	60 uds pcs
B	C6981	Pincho largo / Large mocktail stick	13.5	0.2	60 uds pcs
C	C6982	Tenedor aperitivo / Appetizer fork	13.5	0.2	60 uds pcs
D	C6983	Cuchara aperitivo / Appetizer spoon	13.5	0.2	60 uds pcs
E	C6996	Pinza corta / Short clamp	16	0.2	6 uds pcs
F	C6995	Pinza larga / Long clamp	22.2	0.2	6 uds pcs
G	C6997	Pinza espátula / Spatula clamp	16	0.2	6 uds pcs
H	C6988	Cuchara larga / Large spoon	21.5	0.2	60 uds pcs
I	C6989	Cuchara café espátula / Spatula coffee spoon	10.8	0.2	60 uds pcs
J	C6976	Cuchillo mesa monobloc / Monoblock table knife	16	0.2	60 uds pcs
K	C6977	Tenedor mesa / Table fork	15.4	0.2	60 uds pcs
L	C6978	Cuchara mesa / Table spoon	15.3	0.2	60 uds pcs
M	C6979	Tenedor arroz / Rice fork	14.8	0.2	60 uds pcs
N	C7891	Cuchillo lunch monobloc / Monobloc cake knife	18.3	0.2	60 uds pcs
O	C6986	Tenedor lunch / Cake fork	12.5	0.2	60 uds pcs
P	C6985	Cuchara lunch / Cake spoon	12.5	0.2	60 uds pcs
Q	C6984	Cuchara moka / Moka spoon	10.1	0.15	60 uds pcs
R	C6998	Cuchara degustación / Tasting spoon	8.6	0.2	6 uds pcs
S	C6999	Cuchara degustación oval / Oval tasting spoon	10.1	0.2	6 uds pcs

## LAB VINTAGE GOLD



## LAB VINTAGE COOPER



## LAB ICE BLACK



## LAB COLORS



	GOLD	COPPER	BLACK		◆ cm	✕ cm	
A	C1539	C1555	C8640	Cuchillo mesa monobloc / Monobloc table knife	16	0.2	60 uds PCS
B	C1541	C1557	C7665	Tenedor mesa / Table fork	15.4	0.2	60 uds PCS
C	C1540	C1556	C8641	Cuchara mesa / Table spoon	15.3	0.2	60 uds PCS
D	C1542	C1558	C8642	Tenedor arroz / Rice fork	14.8	0.2	60 uds PCS
E	C1543	C1559	C8643	Pincho / Mocktail stick	10	0.2	60 uds PCS
F	C1544	C1560	C8644	Pincho largo / Large mocktail stick	13.5	0.2	60 uds PCS
G	C1545	C1561	C8645	Tenedor aperitivo / Appetizer fork	13.5	0.2	60 uds PCS
H	C1546	C1562	C8646	Cuchara aperitivo / Appetizer spoon	13.5	0.2	60 uds PCS
I	C1547	C1563	C8647	Cuchara moka / Moka spoon	10.1	0.15	60 uds PCS
J	C1549	C1565	C8649	Cuchara lunch / Cake spoon	12.5	0.2	60 uds PCS
K	C1550	C1566	C8650	Tenedor lunch / Cake fork	12.5	0.2	60 uds PCS
L	C1548	C1564	C8648	Cuchillo lunch monobloc / Monoblock cake knife	13.5	0.2	60 uds PCS
M	C1551	C1567	C8651	Cuchara coctel larga / Large mocktail spoon	21.5	0.2	60 uds PCS
N	C1552	C1568	C8652	Cuchara café espátula / Spatula coffee spoon	10.8	0.2	60 uds PCS
O	C1553	C1569	C8653	Cuchara degustación / Tasting spoon	8.6	0.2	60 uds PCS
P	C1554	C1570	C8654	Cuchara degustación oval / Oval tasting spoon	10.1	0.2	60 uds PCS

Portions have decreased and the refinement of some dishes make it essential to find the appropriate cutlery to taste them.

Tasting menus have relegated the main course to a non-existent plane, where liquid appetizers, suspended solids, aerial and ethereal elements in each composition, broths or infusions accompany and surround all kinds of food, ingredients from the 5 continents are present in the current cuisine, fusion of flavors and cultures, in this type of restaurants the portions are small and austere with the intention of concentrating in small mouthfuls explosions of flavor.

Dishes with an infinite number of shapes and natural supports, have been able to find and adapt to these changes, but not the cutlery.

Their size is often their main problem, spoons designed to sink into a broth, knives and forks grotesquely sized to face such delicacies.

LAB IS THE SOLUTION IN SIZE AND SHAPE



## EL PORQUÉ DE LAB THE REASON FOR LAB

Las raciones han disminuido y el refinamiento de algunos platos hacen indispensables buscar el cubierto apropiado para degustarlo.

Los menús degustación han relevado al plato principal a un plano inexistente, donde aperitivos líquidos, sólidos suspendidos, elementos aéreos y etéreos en cada composición, caldos o infusiones acompañan y rodean todo tipo de alimentos, ingredientes de los 5 continentes son presentes en la cocina actual, fusión de sabores y culturas.

En este tipo de restaurantes las porciones son pequeñas y austeras con la intención de concentrar en pequeños bocados explosiones de sabor. Platos con infinidad de formas y soportes naturales, han sabido buscar y adaptarse a estos cambios, pero no así los cubiertos.

Su tamaño es muchas veces su principal problema, cucharas pensadas para hundirse dentro de un caldo, cuchillos y tenedores grotescamente dimensionados para enfrentarse a tales delicadezas.

LAB ES LA SOLUCION EN DIMENSIONES Y FORMAS

## LAB ACCESORIOS LAB ACCESSORIES

Introducing our latest collection, designed with diverse materials, shapes, and colors. With its minimalist lines, this set is perfect for serving appetizers, tapas, rice dishes, and so much more. Our collection also includes sleek stainless steel plates, matte porcelain plates, and wooden bases that add to its versatility, making it a must-have for any occasion.

Esta colección está diseñada en diferentes materiales, formas y colores. Un conjunto de líneas minimalistas que permite servir aperitivos, tapas, arroces y un sinfín de emplatados. También cuenta con platos de acero inoxidable, porcelana mate y bases de madera, creando un conjunto muy versátil.

Base madera  
Wood tray

4 uds  
4 pcs

C8370 Simple 9.25 x 27.8 cm

C8371 Doble 18.5 x 27.8 cm



C8001  
Disco Pinchos  
Round Stick Holder

Ø 9 cm  
Altura / Height: 2,75 cm

4 uds  
4 pcs



## LAB TABLE TOP



4 uds  
pcs

**C8000**

Plato 1/4 ración redondo  
1/4 ration circle plate

9.25 x 9.25 cm



4 uds  
pcs

**C8005**

Plato ración oval  
1 ration oval plate

9.25 x 27.8 cm



4 uds  
pcs

**C8002**

Plato ración redondo  
1 ration circle plate

18.5 x 18.5 cm



4 uds  
pcs

**C8004**

Plato 1/4 ración redondo doble  
1/4 ration circle double plate

9.25 x 18.5 cm



4 uds  
pcs

**C8003**

Plato 1/2 ración oval  
1/2 ration oval plate

9.25 x 18.5 cm



4 uds  
pcs

**C8006**

Plato 1/2 ración oval + pinchos  
1/2 ration oval plate + stick holder

9.25 x 27.8 cm



Base porcelana grande  
Double porcelain tray

4 uds  
pcs

C8599 Blanco / White

C8601 Verde / Green

C8603 Azul / Blue

C8597 Negro / Black

18.5 x 18.5 cm

4 uds  
pcs

C9984  
Plato gest  
Gest plate

11 x 10.5 cm Alt / Height: 3 cm

4 uds  
pcs

Base porcelana pequeña  
Simple porcelain tray

C8598 Blanco / White

C8600 Verde / Green

C8602 Azul / Blue

C8596 Negro / Black

9.25 x 27.8 cm

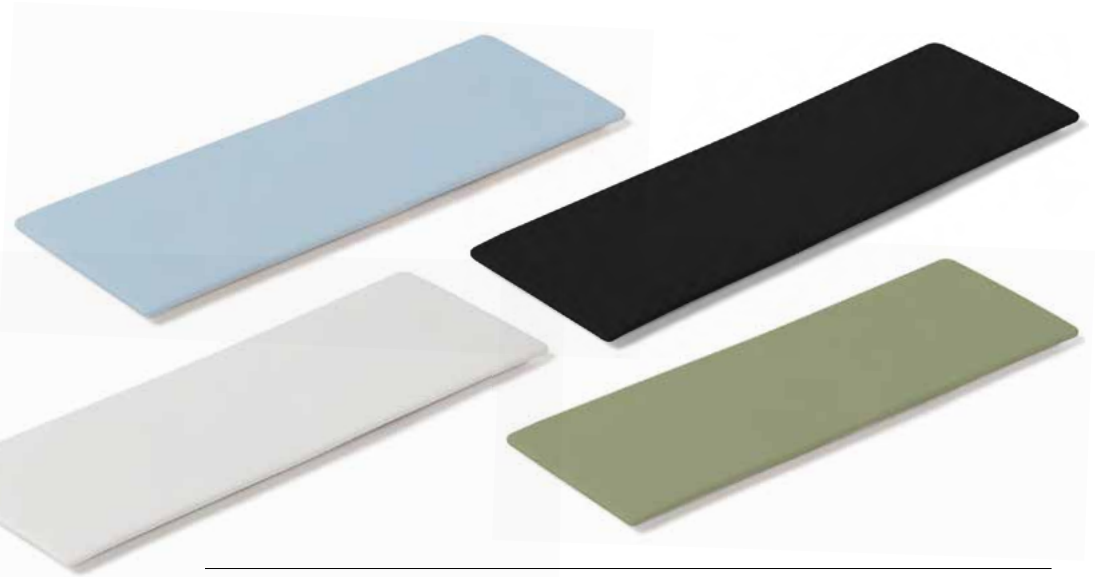



## VERSAILLES

Introducing our elegant cutlery set with a classic design that adds a touch of sophistication to your table. The pieces are robust and delicately decorated from the beginning to the end of the handle, radiating elegance and charm.

Made from 18/10 stainless steel, this cutlery can withstand intensive use. With four different colors to choose from, you can customize your table setting to suit any occasion and style. An exquisite cutlery set with timeless beauty.

Elegante cubertería con un diseño clásico que aporta un toque de sofisticación a mesa.

Las piezas son robustas y están decoradas con delicadeza desde el inicio hasta el final del mango, irradiando elegancia y encanto. Hecha de acero inoxidable 18/10, esta cubertería puede soportar un uso intensivo.

Disponible en cuatro colores diferentes.

Una exquisita cubertería de belleza atemporal.



## VERSAILLES SATIN



A



B



C



D



E



F



G



H



I

## VERSAILLES SATIN GOLD



A



B



C



D



E



F



G



H



I

## VERSAILLES SATIN BLACK



VERSAILLES SATIN COPPER



## VERSAILLES



	SATIN	GOLD	BLACK	COPPER		◆ cm	✕ cm	60 uds pcs
A	C7765	C5736	C5745	C5754	Cuchillo mesa / Table knife	24.5	0.35	
B	C7766	C5737	C5746	C5755	Cuchara mesa / Table spoon	21	0.35	
C	C7767	C5738	C5747	C5756	Tenedor mesa / Table fork	21	0.35	
D	C7770	C5739	C5748	C5757	Cuchillo postre / Dessert knife	22	0.35	
E	C7771	C5740	C5749	C5758	Cuchara postre / Dessert spoon	19	0.3	
F	C7772	C5741	C5750	C5759	Tenedor postre / Dessert fork	19	0.3	
G	C7773	C5742	C5751	C5760	Tenedor lunch / Cake fork	14	0.25	
H	C7774	C5743	C5752	C5761	Cuchara café / Tea spoon	14	0.25	
I	C7775	C5744	C5753	C5762	Cuchara moka / Moka spoon	11.5	0.18	

## ATLÁNTIDA

Collection of cutlery with fluid lines, extremely sophisticated and contemporary. It is made of textured stainless steel, providing each piece with a very pleasant touch and weight.

Its minimalism allows it to be easily combined with plates and dishes of different styles and shapes, making it a versatile addition to any table.

Colección de cubiertos con líneas fluidas, extremadamente sofisticada y contemporánea. Está realizada en acero inoxidable texturizado, proporcionando a cada pieza un tacto y peso muy agradable. Su minimalismo permite combinarla fácilmente con platos y vajillas de diferentes estilos y formas, convirtiéndola en una adición versátil a cualquier mesa.



4 uds  
pcs

C10431  
Reposa cubiertos  
Cutlery holder

19 x 8 cm

Base de acero y madera.  
Steel and wood base.

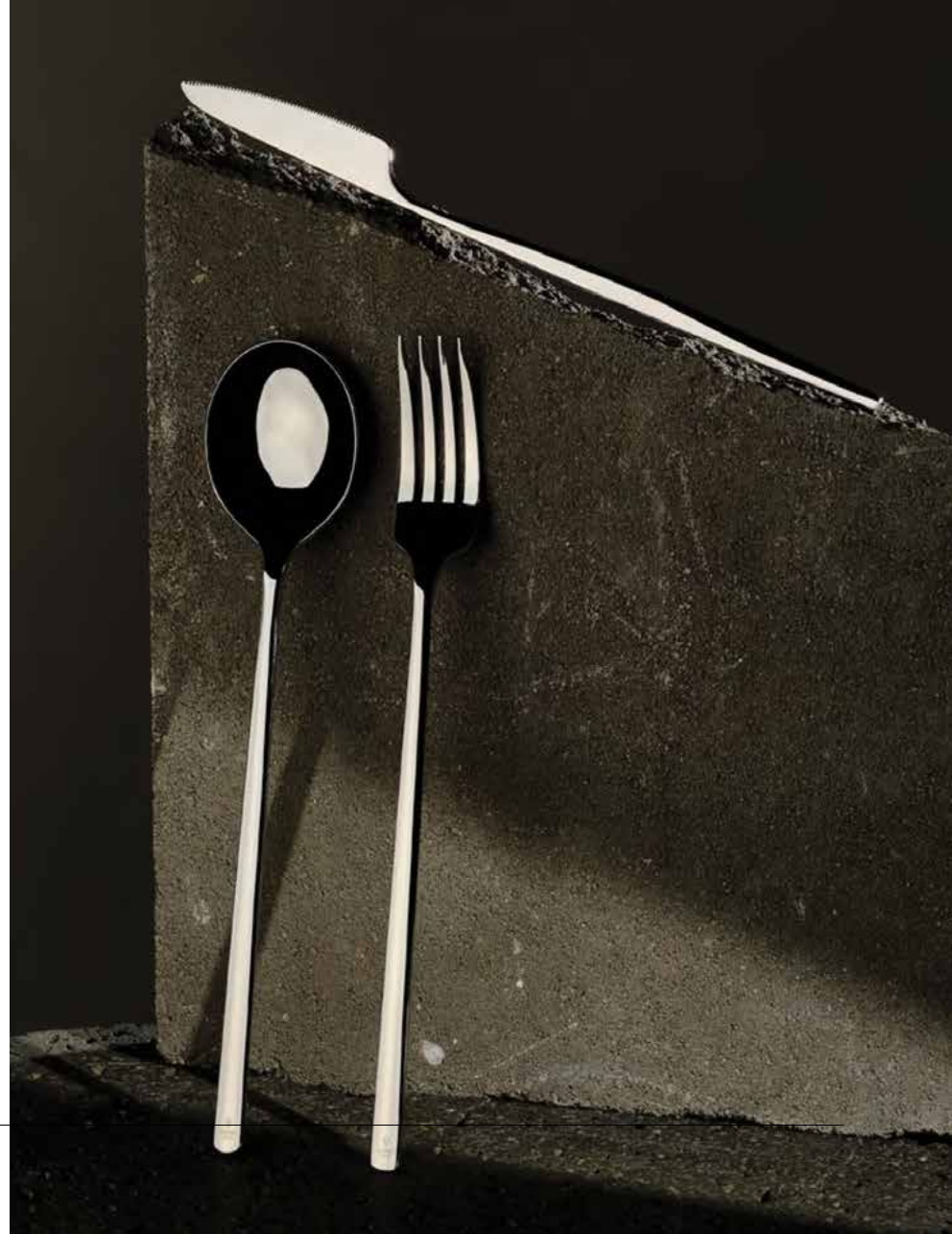

## ATLÁNTIDA MIRROR

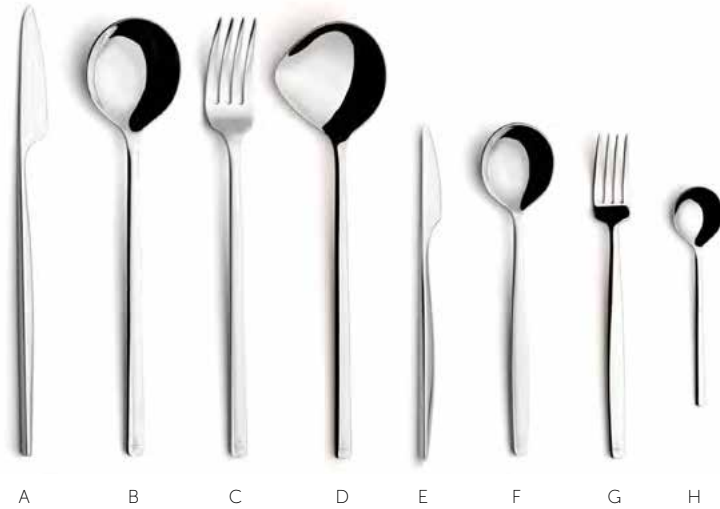

			◆ cm	✕ cm	60 uds pcs
A	C8586	Cuchillo mesa / Table knife	22.6	0.6	
B	C8587	Cuchara mesa / Table spoon	21.5	0.6	
C	C8588	Tenedor mesa / Table fork	21.8	0.6	
D	C8656	Cuchara salsa / Sauce spoon	21.6	0.6	
E	C8589	Cuchillo lunch / Cake knife	16.9	0.6	
F	C8591	Cuchara lunch / Cake spoon	16.3	0.5	
G	C8590	Tenedor lunch / Cake fork	16	0.5	
H	C8592	Cuchara café / Tea spoon	10.9	0.35	
I	C10431	Reposa cubiertos / Cutlery holder	19	0.15	4 uds pcs

## ATLÁNTIDA BLACK



			◆ cm	✕ cm	60 uds pcs
A	C8579	Cuchillo mesa / Table knife	22.6	0.6	
B	C8580	Cuchara mesa / Table spoon	21.5	0.6	
C	C8581	Tenedor mesa / Table fork	21.8	0.6	
D	C8655	Cuchara salsa / Sauce spoon	21.6	0.6	
E	C8582	Cuchillo lunch / Cake knife	16.9	0.6	
F	C8584	Cuchara lunch / Cake spoon	16.3	0.5	
G	C8583	Tenedor lunch / Cake fork	16	0.5	
H	C8585	Cuchara café / Tea spoon	10.9	0.35	



Mango hueco para una manipulación más ligera



Hollow handle for lighter handling



## Set palillos inox Chopsticks set 18/10

12 sets

C7421 Inox

C7422 PVD Black

C7423 PVD Copper

C7424 PVD Gold

23 x 1.1 cm

Mini cutlery made of 18% stainless steel, nickel-free. For these size are perfect for tasting different flavors and dishes anytime, anywhere. Designed to last and withstand daily use.

Mini cubiertos de Inox 18%, libre de níquel. Su tamaño es perfecto para degustar diferentes sabores y platos en cualquier momento y lugar.

Diseñados para durar y resistir el uso diario.

## Finger food 24 uds pcs

C8784 Cuchillo lunch / Cake knife 140 x 0.6 cm

C8786 Cuchara café / Tea spoon 140 x 0.6 cm

C8785 Tenedor lunch / Cake fork 140 x 0.6 cm

C8787 Pincho tapas / Mocktail stick 140 x 0.6 cm

## SILEX

Inspired by the oldest tools of the Stone Age, Silex cutlery emulates the hardness and cutting ability of the earliest weapons. A steak knife and fork that impress with their size of 18.5 cm and satin touch. Made of 18/10 stainless steel.

Inspirada en las herramientas más antiguas de la edad de piedra, la cubertería Silex emula la dureza y la capacidad de corte de las armas más antiguas.

Un cuchillo y un tenedor chuletero que impresionan por su tamaño de 18,5 cm y tacto satinado. Realizados en INOX 18/10.



C6318 Cuchillo chuletero / Steak knife 20 uds / 20 pcs

C6319 Tenedor chuletero / Steak fork 20 uds / 20 pcs

C6322 Cuchillo + tenedor / Knife + fork 8 uds / 8 pcs

18.5 cm



## LES ESSENCES

New concept for catering service with design pieces that complement each other to create a practical and versatile set without sacrificing elegance.

The set is composed of aluminum trays, light, resistant and perfect for a comfortable service.

Suitable for baking and in some cases compatible with the GN 1/1 system.

It also has supports for different types of plating such as lollipops, cones, tacos or skewers. As well as stainless steel tasting spoons, designed for tasting quick appetizers.

Finally, it offers a high quality porcelain tableware fully modular to match the trays.

Nuevo concepto para el servicio de catering con piezas de diseño totalmente complementarias entre ellas para crear un conjunto práctico y versátil sin renunciar a la elegancia.

El conjunto está compuesto por bandejas de aluminio, ligeras, resistentes y perfectas para un servicio cómodo.

Aptas para hornear y en algunos casos compatibles con el sistema GN 1/1.

También cuenta con soportes para diferentes emplatados como piruletas, conos, tacos o brochetas. Así como cucharas de degustación en acero inoxidable, pensadas para la degustación de aperitivos rápidos.

Finalmente, nos ofrece una vajilla de porcelana de alta calidad totalmente modulable a juego con las bandejas.



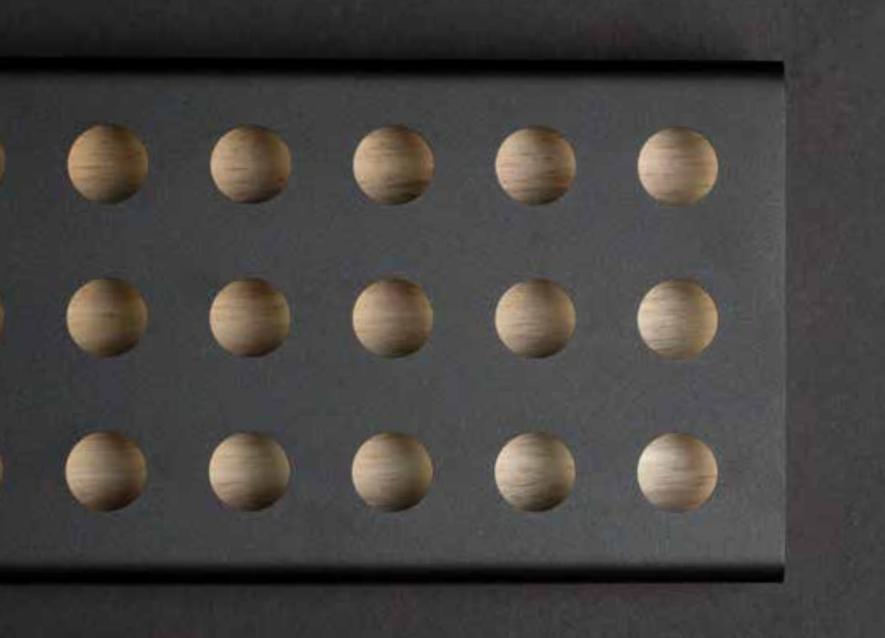

# Cucharas degustación

## Tasting spoons



Cuchara degustación plana  
Flat tasting spoon

12 uds  
pcs

C7576 ● Vintage

C7577 ● Vintage PVD intense gold

C7578 ● Vintage PVD pure carbon

8.5 cm

Especialmente pensada para la degustación de aperitivos en un servicio de catering.

Specially designed for tasting appetizers in a catering service.



Al igual que los soportes, la cucharas de degustación están pensadas para la degustación de aperitivos y snacks rápidos durante un servicio de catering. Dispone de diferentes modelos que permiten variedad de emplatados. Fabricadas en acero inoxidable 18/10 con un recubrimiento de PVD.

El PVD es una tecnología de recubrimiento avanzada y versátil que mejora significativamente la durabilidad y la estética de cualquier objeto.

Just like supports, tasting spoons are designed for the tasting of appetizers and quick snacks during a catering service. They come in different models that allow for a variety of plating options. Made of 18/10 stainless steel with a PVD coating.

PVD is an advanced and versatile coating technology that can significantly improve the durability and aesthetics of any object.



### Cuchara degustación mango Handle tasting spoon

12 uds  
pcs

- C7564 ● Perforated vintage
- C7565 ● Vintage
- C7566 ● Vintage PVD intense gold
- C7567 ● Vintage PVD pure carbon

12 cm



### Cuchara degustación espátula Spatula tasting spoon

12 uds  
pcs

- C7572 ● Perforated vintage
- C7573 ● Vintage
- C7574 ● Vintage PVD intense gold
- C7575 ● Vintage PVD pure carbon

7.5 cm



### Cuchara degustación pala Spade tasting spoon

12 uds  
pcs

- C7568 ● Perforated vintage
- C7569 ● Vintage
- C7570 ● Vintage PVD intense gold
- C7571 ● Vintage PVD pure carbon

7.5 cm

Asas y paredes oblicuas para facilitar el apilado

Handles and oblique walls for easy stacking

Pie de 5mm de grossor que evita que la bandeja apoye directamente en la mesa, dando un aspecto más ligero.

5mm thick foot that prevents the tray from resting directly on the table, giving a lighter appearance.



### Bandeja rectangular pequeña Small tray

4 uds  
pcs

C7579 ● Soft Argento

C7588 ● Pure carbon

15 x 27 cm  
Alt/Height: 6.9 cm



Trays with a stackable and very light design, supports freezing and temperatures up to 80°C. They are also dishwasher safe.

Bandejas con un diseño apilable y muy ligero, soportan la congelación y temperaturas de hasta 80°C. También son aptas para lavavajillas.

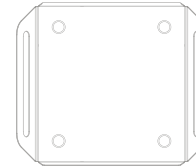

### Bandeja cuadrada Square tray

4 uds  
pcs

C7581 ● Soft Argento

C7590 ● Pure carbon

28.5 x 27 cm  
Alt/Height: 6.9 cm





Bandeja rectangular estrecha  
Tight tray

4 uds  
pcs

C7580 ● Soft Argento

C7589 ● Pure carbon

15 x 52.5 cm  
Alt/Height: 9.6 cm



Bandeja rectangular grande  
Big tray

4 uds  
pcs

C7582 ● Soft Argento

C7591 ● Pure carbon

28 x 52.5 cm  
Alt/Height: 9.6 cm





## Bandeja room service Room Service Tray

4 uds  
4 pcs

C7930 ● Soft Argento

38.5 x 52 cm

Alt/Height: 6.9 cm



The room service tray has special measurements. It is the largest tray in the collection and together with the porcelain tableware Les Essences, it is perfect for serving a complete meal in the room, as well as for a restaurant service.

La bandeja room service dispone de unas medidas especiales. Es la bandeja más grande de la colección y junto con la vajilla de porcelana Les Essences, es perfecta tanto para servir una comida completa en habitación, como para un servicio de sala.



## Cubrebandeja silicona Silicon Tray Cover

4 ud  
4 pc

C7438 14.5 x 26.5 cm Compatible: C7579 / C7588

C7439 14.5 x 52 cm Compatible: C7580 / C7589

C7440 28 x 26.5 cm Compatible: C7581 / C7590

C7441 28 x 52 cm Compatible: C7582 / C7591



## Cubrebandeja corcho rectangular Cork Tray Cover

4 ud  
4 pc

C7845 14.5 x 26.5 cm Compatible: C7579 / C7588

C7846 14.5 x 52 cm Compatible: C7580 / C7589

C7847 28 x 26.5 cm Compatible: C7581 / C7590

C7848 28 x 52 cm Compatible: C7582 / C7591

C7931 38 x 51.5 cm Compatible: C7930



## Vajilla Tableware

This high-quality porcelain dinnerware is crafted through a two-step firing process at temperatures exceeding 1200°C. It's food colors resistant, hard work resistant but smooth to the touch, and features a modular design that fits seamlessly onto the collection's aluminum trays.

Vajilla de porcelana de alta calidad fabricada en 2 tiempos de cocción a más de 1200°C. Impermeable a manchas de los alimentos, resistente y suave al tacto tienen un diseño modular que encaja perfectamente sobre las bandejas de aluminio de la colección.

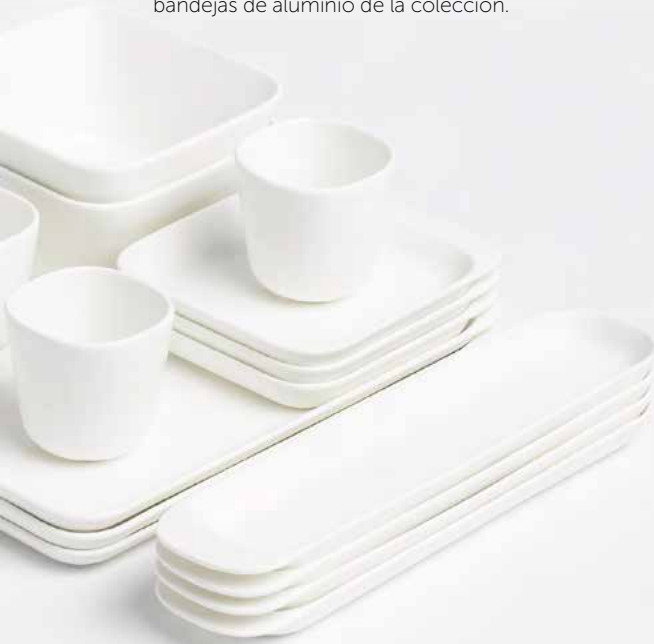

70 ml



400 ml



### Vajilla de porcelana Porcelain Tableware

4 uds  
pcs

A	C7679	Vaso / Cup	6 x 6 cm Alt /Height: 6 cm
B	C7670	Bol / Bowl	12 x 12 cm Alt /Height: 12 cm
C	C7681	Plato postre / Dessert plate	12 x 12 cm Alt /Height: 1.8 cm
D	C7672	Plato llano / Dinner plate	24 x 24 cm Alt /Height: 1.3 cm
E	C7671	Bandeja simple / Simple tray	12 x 24 cm Alt /Height: 1.5 cm
F	C7680	Barquillo / Wafer	6 x 24 cm Alt /Height: 1.8 cm
G	C7673	Bandeja doble / Double tray	12 x 48 cm Alt /Height: 1.3 cm





## Bandeja sistema GN 1/1 GN 1/1 Tray system



Apilable para un mejor almacenaje  
Stackable for easy storage

Con las medidas estándar del sistema de catering Gastronorm, esta bandeja puede ser utilizada tanto para almacenamiento seco o refrigerado, cocinado y presentación de alimentos.

Son la solución ideal para usar en vitrinas, buffets o mesas frías.

Igual que las otras bandejas de la colección, están fabricadas en aluminio mate.

With standard dimensions of Gastronorm catering system, this tray can be used for both dry and refrigerated storage, cooking and food presentation.

Are the ideal solution for use in showcases, buffets or cold tables.

Like the other trays in the collection, they are made of matt aluminum.

Fabricado en aluminio ligero que facilita el transporte y soporta hornados de hasta 250°C

Lightweight aluminum, easy to transport and withstands baking temperatures up to 250°C

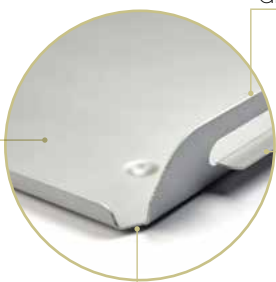

Grueso de 0.15 cm para una mayor resistencia  
0.15 cm thick for extra strenght

Ala externa que permite almacenar las bandejas en los trolley  
External wing for storing trays on trolleys

Su ancho de 32.5 cm encaja tanto en las guías de los hornos industriales como en las cajas de transporte GN

Its 32.5 cm width fits both industrial oven rails and GN transport boxes



Bandeja GN 1/1  
Tray GN 1/1

4 uds  
pcs

C9991 ● Soft argento

C9992 ● Pure carbon

38.5 x 52 cm  
Alt/Height: 6.9 cm



Adaptable a cajas de transporte con guías  
Adaptable to transport boxes with guides

1 ud  
pc

C10785  
Cubrebandeja silicona GN 1/1  
Silicon tray cover GN 1/1  
32.5 x 53 cm



No resbala, protege y resiste alta temperatura  
- Non-slip, protective and high temperature resistant



Adaptable a hornos industriales y carros GN  
Adaptable to industrial ovens and GN trolleys



## Soportes Supports

Soportes de aluminio mate para servicio de aperitivos y snacks.

Ligeros, modulares y combinables con las bandejas de la misma colección, ayudaran a agilizar cualquier pase de catering.

These matte aluminum supports are great for serving appetizers and snacks. They are lightweight, modular, and can be combined with trays from the same collection, making it easy to pass food around quickly during any catering event.



Soporte conos  
Cones support

4 uds  
pcs

C7586 ● Soft argento

C7595 ● Pure carbon

12 x 24 cm Alt / Height: 4 cm



Soporte piruletas  
Lollipops support

4 uds  
pcs

C7585 ● Soft argento

C7594 ● Pure carbon

12 x 24 cm Alt / Height: 4 cm



Bandeja madera roble  
Oak wood tray

4 uds  
pcs

C7587

12 x 24 cm Alt / Height: 2 cm



**C7583**  
 Soporte tacos  
 Tacos support  
 12 x 24 cm  
 Alt / Height: 4 cm

4 uds  
 pcs



**C7584**  
 Soporte brocheta  
 Skewers support  
 6 x 24 cm  
 Alt / Height: 4 cm

4 uds  
 pcs



**C7592**  
 Soporte tacos  
 Tacos support  
 12 x 24 cm  
 Alt / Height: 4 cm

4 uds  
 pcs

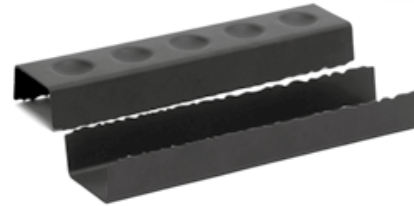

**C7593**  
 Soporte brocheta  
 Skewers support  
 6 x 24 cm  
 Alt / Height: 4 cm

4 uds  
 pcs



*"Practicidad y estilo profesional para realzar presentaciones en eventos y servicios gastronómicos"*

*"Practicality and professional style to enhance presentations in events and gastronomic services"*



# CATERING

BANDEJAS / TRAYS ..... 409

SOPORTES Y EMPLATADOS /  
STANDS & PLATINGS ..... 413

Piezas únicas para presentar tus preparaciones  
Unique pieces to display your preparations

SELLADO / SEALING ..... 437

Envases y herramientas para el sellado  
Containers and sealing tools

DESECHABLES / DISPOSABLES ..... 455

Productos de un solo uso  
Single-use products

## Ledpad Bar

Ilumina y sorprende en todos tus servicios  
Light up and surprise in all your services

Con una iluminación regulable de 3 de niveles de brillo, podrás ajustar la luz para crear el ambiente perfecto para cada ocasión.

Su batería recargable de **carga rápida**, disfrutarás de hasta 5 horas de autonomía, pudiendo ofrecer servicios en restaurantes, clubs o todo tipo de eventos.

With adjustable lighting and 3 brightness levels, you can adjust the light to create the perfect atmosphere for every occasion.

With its **fast-charging** rechargeable battery, you can enjoy up to 5 hours of battery life, allowing you to offer services in restaurants, clubs, or all kinds of events.

100/0206

LedPad Bar

Ø 36 cm



### Diseños personalizables

Customizable designs

Tapa de cierre de silicona para proteger la entrada USB de líquidos /  
Silicone rubber seal to protect the USB port from liquids

Se puede utilizar con o sin bandeja

Medida estándar compatible con bandejas de bares y restaurantes /

It can be used with or without tray.

Standard size compatible with bar and restaurant trays.





¡Personaliza!  
Customize!



6 uds  
pcs

100/0207  
Bandeja Camarero  
Waiter's tray

Ø 40 cm



12 uds  
pcs

100/0208  
Bandeja antideslizante  
Non-slip tray

Ø 40 cm



## Bandeja iluminación Led Led light Tray

100/0199  
LedPad GN 1/1

32.5 x 53 cm

1 uds  
pcs

**4h**  
de duración  
endurance

Luz regulable en 3 intensidades  
Light adjustable in 3 intensities

25%

60%

100%



Solo para Esseces  
Sistema GN 1/1  
Only for Essences  
System GN 1/1



Botón táctil  
apagado y encendido.  
Touch button  
for power ON/OFF



Batería recargable USB  
Tiempo de carga: 3,5h  
USB rechargeable battery  
Charge duration: 3,5h

No sumergible.  
Lavable con paño húmedo.  
Non-Submersible.  
Washable with a damp cloth.



Patas de silicona para una mayor  
fijación en la superficie.  
Silicone feet for a better fixation  
on the surface.



Conoce más  
Know more

**YouCook**





Lámina acetato personalizable  
Customisable acetate film

6 uds  
pcs

C10786 Agua / Water

C10799 Fuego / Fire

C10800 Tierra / Earth

C10801 Personalizado / Customizable

29.7 x 42 cm

Personalice su bandeja según los platos o aperitivos. También puede pedir una lámina con su logo.  
Customize your tray according to your dishes or appetizers. You can also order a plate with your logo.

Lámina de metacrilato protectora  
Apto para contacto alimentario  
Protective methacrylate sheet  
Suitable for food contact

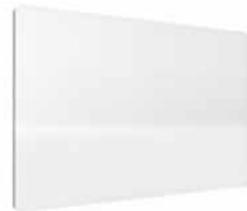

4 uds  
pcs

C10808  
Lámina metacrilato protector  
Methacrylate protective sheet

32.5 x 53 cm

Lámina personalizable  
para cualquier emplatado  
Customisable film for any dish

Base Led GN 1/1  
Led tray GN 1/1

Bandeja GN 1/1 Les Essences  
Tray GN 1/1 Les Essences

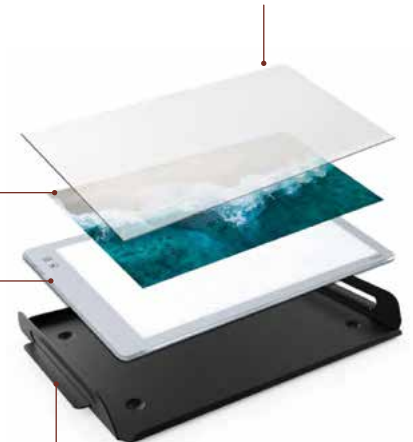

## Colección BIANCO

### BIANCO Collection

Originales piezas de diseño con elegante acabado blanco mate, pensadas para presentar piezas de 2 en 2 o de 4 en 4. Ofrecen una multitud de posibilidades y combinaciones de presentación: tacos, mini bocaditos, bollería, etc. Termo-formadas en resina acrílica: material ligero a baja densidad, altamente resistente, preparado para resistir ambientes salinos, exposición al vapor, ambientes helados o congelados. Prácticamente indestructibles, no se rayan ni se manchan con la comida, pueden pulirse con un estropajo verde y como nuevas. Además son resistentes hasta 80°C y 100% reciclables.

Unique design made to present 2 pieces or 2 pairs of food at the time, made with an elegant white matte finish. This support is extremely versatile: serve tacos, mini sandwiches, pastries. Thermoformed with acrylic resin: a low-density and light material, super-resistant and salt-proof. It resists to vapor, freezer and temperatures until 80°C. Virtually indestructible, they don't get stained by food. Easy to clean with a scouring pad. 100% Recyclable.

500/0003  
WAVE CRUNCHY 1

7 x 6 cm  
Altura / Height: 4 cm



500/0004  
WAVE CRUNCHY 2

13 x 6 cm  
Altura / Height: 4 cm



500/0005

WAVE TACO 2/3

21 x 6 cm

Altura / Height: 4.5 cm



500/0002

WAVE BAGUETTE 2

15.5 x 10 cm

Altura / Height: 5 cm

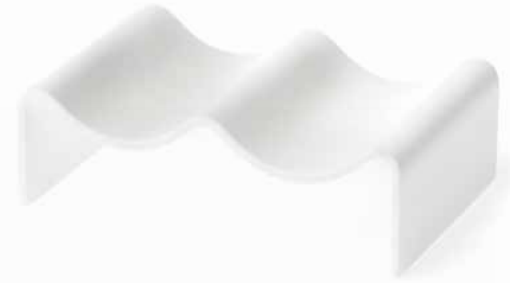

500/0006

WAVE TACO 4/5

35.5 x 6 cm

Altura / Height: 4.5 cm

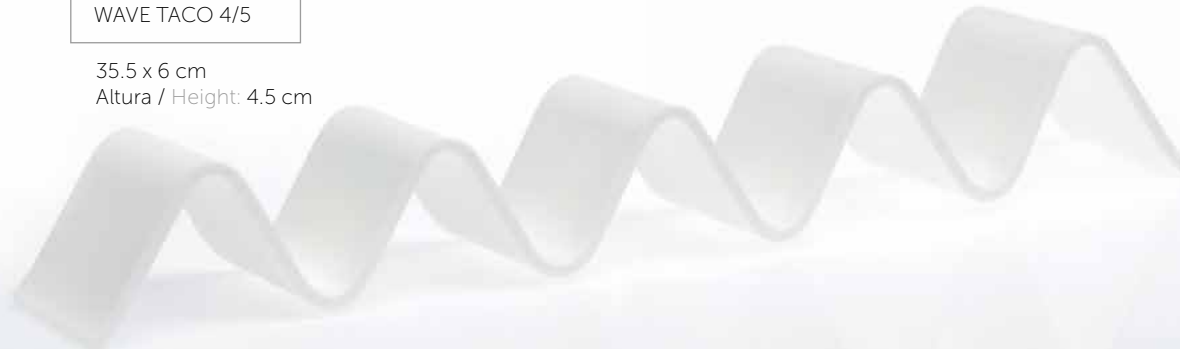

500/0001

WAVE BAGUETTE 4

29.5 x 10 cm

Altura / Height: 5 cm



500/0201  
SPRING CONE

9 x 6 cm  
Altura / Height: 4.5 cm

500/0202  
SPRING PIPETTE

9 x 6 cm  
Altura / Height: 5 cm



500/0110  
BRIDGE FLAT / HOLE



500/0105  
BRIDGE DUO

500/0203  
SPRING CRUNCHY

9 x 6 cm  
Altura / Height: 4.5 cm



500/0204  
SPRING SKEWER

9 x 6 cm  
Altura / Height: 4.5 cm

500/0103  
BRIDGE LABO

8 x 7 cm  
Altura / Height: 15.5 cm



500/0101  
BRIDGE DOUBLE HOLE

Ø 4 cm



500/0102  
BRIDGE HOLE

Ø 4 cm



500/0106  
BRIDGE DOUBLE HOLLOW



500/0109  
BRIDGE FLAT

8 x 7 cm  
Altura / Height: 8 cm

500/0107  
BRIDGE HOLLOW

500/0108  
BRIDGE DOUBLE FLAT

15.5 x 7 cm  
Altura / Height: 8 cm

500/0104  
BRIDGE COMBI



## GRADILLAS ALUMINIO

aluminium display

100/0011

25

12 x 12 cm  
Altura / Height: 6 cm

100/0012

50

22 x 12 cm  
Altura / Height: 7 cm

Ø 1.6 cm



100/0017

Escobilla para limpieza tubos de ensayo  
Cleaning brush for probe tubes

100/0064

Soporte redondo conos y brocheta  
Round stand for cone and skewer

Ø 3 cm Alt / Height: 4.5 cm



100/0065

Soporte redondo duplo para brocheta  
Double roundstand for skewers

Ø 3 cm Alt / Height: 4 cm



## SOPORTES TARIMA tarima supports

100/0092      Transparente / Clear

100/0093      Blanco / White

100/0094      Negro / Black



Medidas / Size: 6.5 x 6.5 cm - Altura / Height: 8.5 cm - Agujero / Hole: Ø 4 mm



## TUBOS DE ENSAYO

### Test tubes

Tubos de ensayo con reborde, ideal para beber pequeños cocktails o servir infusiones o sopas de acompañamiento. Fabricados en vidrio borosilicato, es extremadamente duro, con alta resistencia a los cambios bruscos de temperatura.

Test tubes with thread, made from borosilicate (an extremely hard glass), with a high resistance to temperature changes.

Ideal for small cocktails drinking or for serving creative drinks or accompaniment soups.



100/0054  
Tapones de corcho para tubos de Ø 1.6 cm  
Cork for test tubes of Ø 1.6 cm

200 uds pcs

100/0172  
Tubo de ensayo maxi  
Maxi test tube

40 uds pcs

90 ml

Ø 2,5 cm  
Altura / Height: 25 cm

100/0009  
Tubos de ensayo de borosilicato  
Borosilicate labo tubes

100 uds pcs

20 ml

Ø 1.6 cm Altura / Height: 15 cm

100/0018  
Taza tubo de borosilicato  
Borosilicate tube with handle

24 uds pcs

30 ml

Ø 1.8 cm

100/0028  
Taza tubo de borosilicato  
Borosilicate tube with handle

24 uds pcs

20 ml

Ø 1.6 cm





100/0173  
Tapón Negro Silicona  
Silicone Black Tube Cap

10 uds  
pcs

Ø 2,5 cm  
Altura / Height: 3.3 cm

100/0171  
Tubo de ensayo maxi  
Maxi test tube

20 uds  
pcs

90 ml

100/0172  
Tubo de ensayo maxi  
Maxi test tube

40 uds  
pcs

90 ml

Ø 2,5 x 25 cm



PETRI

160/5056	Ø 6 x 2 cm	12 uds/pcs
160/5057	Ø 8 x 2 cm	10 uds/pcs
160/5058	Ø 10 x 2 cm	8 uds/pcs

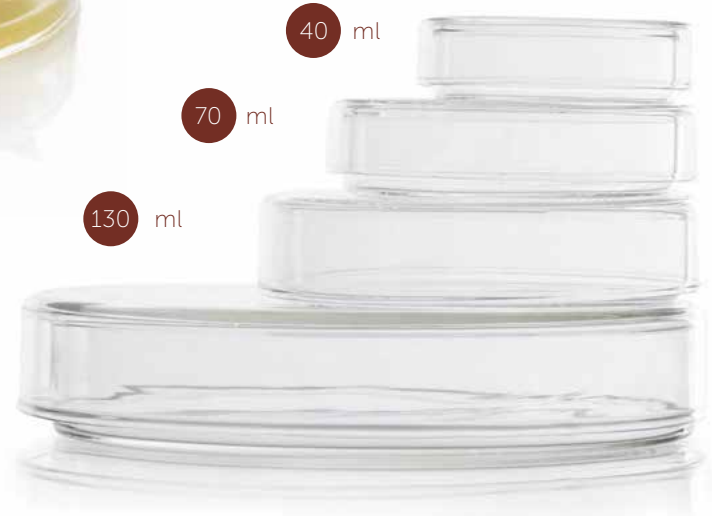

# EAT & DRINK

Versátiles e indispensables para el servicio de aperitivos y tapas creativas así como coctelería, pre-postres, decoración de platos, etc. Resistentes al ácido del vinagre o del limón, lo que las hace indispensables para el uso de salsas ácidas como vinagretas o escabeches.

Versatiles and very resistant to the acids and all kind of liquids. Indispensable for serving appetizers & snacks, cocktails, desserts, vinaigrettes, sauces, juices.



APTO PARA CONTACTO CON ALIMENTOS  
FOOD GRADE MATERIAL

Pueden congelarse en nitrógeno líquido.  
Can be frozen with liquid nitrogen.

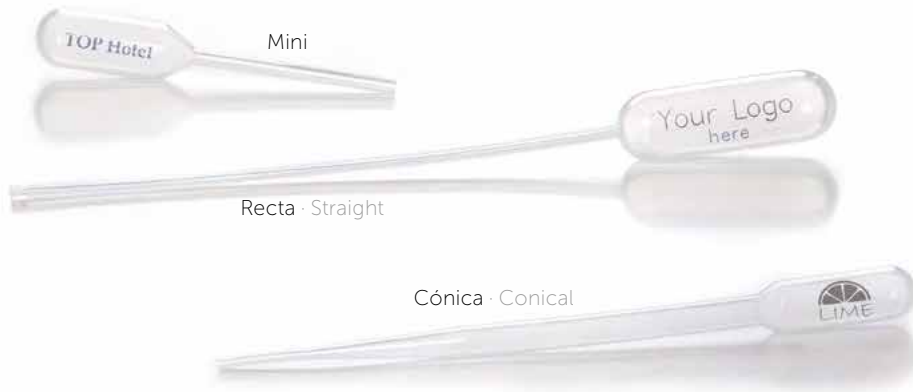

## PIPETAS POLIETILENO POLYETHYLENE PIPETTES

500 uds  
pcs

100/0013	Recta · Straight	4.5 ml / 15.5 cm	
100/0014	Cónica · Conical	5 ml / 15.5 cm	
100/0015	Mini	1.2 ml / 6.5 cm	
100/2008	Estrella	1.2 ml / 6.5 cm	
100/2009	Lollipop	1.2 ml / 6.5 cm	
100/2010	Corazón	1.2 ml / 6.5 cm	



Miniaturas / Miniatures

Cazuelas y sartenes de acero esmaltado de alta calidad y en formato miniatura. Gran resistencia al uso cotidiano, permiten cocinar a fuego de gas, eléctrico, inducción y horno. Además pueden ser lavados en el lavavajillas. Ideal para presentar los platos o medias raciones de cocina tradicional.

Wide range of miniature pots and pans made of high-quality enameled steel. High resistance to daily use. Allows cooking with gas, electric, or induction hobs and oven. Dishwasher-safe. Ideal for presenting full or half portions of traditional cuisine.



P/50003  
Sisi Tendedero Mini  
Mini Clothes Line "Sisi"

24 x 11 cm  
Altura / Height: 16 cm

PC/68588  
Pinza Tendedero Mini  
Clothesline Tongs

Largo / Long: 3 cm

100 uds  
pcs

Pallet

PC/66300	Mini	12 x 12 cm	Alt / Height: 1 cm	5 uds pcs
PC/66303	Medium	20 x 12 cm	Alt / Height: 2 cm	
PC/66305	Long	45 x 15 cm	Alt / Height: 3 cm	1 uds pcs





220/0300  
Plato Vintage  
Vintage plate

6 uds  
pcs

Ø 22 cm



220/0303  
Copa para helado Vintage  
Vintage ice cream cup

4 uds  
pcs

Ø 11,8 cm  
Altura / Height: 10,25 cm



Bandeja semi oval vintage  
Semi oval vintage tray

6 uds  
pcs

220/0301 M 19,5 x 11 cm

220/0302 L 24 x 14,25 cm



220/0304  
Soporte para tartas Vintage  
Vintage cake stand

Ø 23 cm  
Altura / Height: 7 cm

220/0306  
Mini cazo vintage  
Mini vintage saucepan

Ø 7,8 cm  
Altura / Height: 4,5 cm

6 uds  
6 pcs



220/0305  
Mini olla Vintage  
Mini Vintage pot

Ø 11,5 cm  
Altura / Height: 4,5 cm

6 uds  
6 pcs



Moskow Mule Ø8,25 x 9,5 cm

220/0307 Vintage

220/0313 Cobre / Copper



220/0314  
Vaso termo cobre  
Copper thermal tumbler

Ø 6,5 cm  
Altura / Height: 12,75 cm

6 uds  
pcs



220/0310  
Plato hondo Vintage  
Vintage soup plate

Ø 19,5 cm  
Altura / Height: 3,5 cm

6 uds  
pcs



220/0309  
Bol Vintage  
Vintage bowl

Ø 6,25 cm  
Altura / Height: 3,5 cm

24 uds  
pcs

220/0312  
Sartén Vintage  
Vintage skillet

6 uds  
pcs

Ø 13,5 cm  
Altura / Height: 3,75 cm



220/0311  
Rustidera Vintage  
Vintage roasting pan

6 uds  
pcs

18,5 x 12,5 cm  
Altura / Height: 4,5 cm

220/0308  
Stand para marisco Vintage  
Vintage seafood stand

T1: Ø 22 x 6 cm T2: Ø 27,5 x 6 cm  
Altura / Height: 21,25 cm



## Maderas del mundo Woods of the world

Platos y boles creados en madera de teca donde cada pieza revela las vetas únicas del material, trazos orgánicos que hacen visible el paso del tiempo y la belleza de lo imperfecto.

These plates and bowls are crafted from teak wood. Each piece reveals the unique grain of the material and features organic lines that showcase the passage of time and the beauty of imperfection.



## Cuidados / Care

La teca conserva su carácter con un cuidado mínimo: basta aplicar, de forma periódica, aceite mineral o de linaza apto para uso alimentario, que protege la superficie y realza su tono dorado.

With minimal care, teak retains its distinctive appearance: simply apply food-grade mineral or linseed oil periodically to protect the surface and enhance its golden hue.



Maderas del mudo  
Woods of the world

100/2013	Bol / Bowl	Ø 20 cm	3	uds pcs
100/2014	Bol Dune / Dune bowl	Ø 24 cm	3	uds pcs
100/2015	Plato / Plate	Ø 30 cm	6	uds pcs

Caoba / Mahogany



100/2011  
Caja "Curruncho"  
"Curruncho" Trunk

Ø 22 cm Alt / Height: 11 cm



Pivota sobre un eje  
Pivots on an axis

Ligeramente cóncavo, especial para salsas  
Slightly concave, especially for sauces



100/2012  
Plato Caoba Slice  
Caoba Slice Plate

Ø 28 cm Alt / Height: 1,5 cm

6  
uds  
pcs



PC/68761  
Vaporera Bambú  
Bamboo Steamer  
Ø 15 x 9 cm

4

uds  
pcs



PC/68760  
Bowl Coco  
Coconut Bowl

10  
uds  
pcs

8 x 11 cm  
Altura / Height: 4 cm



PC/68150  
Hojas de Peepul  
Peepul leaves

500  
uds  
pcs

9 x 11,5 cm aprox.  
(producto natural) / (natural product)



5 uds  
pcs

PC/66301  
Caja fruta mini  
Mini Fruit Box

15 x 9 cm  
Altura / Height: 7 cm



## Cajas marisco / Seafood Boxes

Presente marisco y pescado como en las cajas de productos fresco que se vende en los mercados y pescaderías. Junto a la caja de metacrilato que encaja perfectamente en ésta puede servir los alimentos con hielo, con nieblas de nitrógeno, hielo seco o con humo frío.

8 uds  
pcs

100/2001  
Caja marisco  
Seafood Box

21 x 13 cm  
Altura / Height: 5 cm



Present seafood and fish as in the boxes you can find in the markets or fish markets. Wooden boxes with logo printed in Spanish on one side and in English on the other. Use with the methacrylate box that fits this box perfectly. You will be able to serve food with ice, fog nitrogen smoke or even dry ice.



## Caja metacrilato marisco Seafood Methacrylate Box

100/2002 1K 18 x 12 cm Altura / Height: 5 cm

100/2006 2K 27 x 18 cm Altura / Height: 7 cm

100/2007 3K 37 x 29 cm Altura / Height: 6.6 cm

Diseñada para encajar perfectamente y servir los alimentos con hielo, con nieblas de nitrógeno, hielo seco y humo frío.

Designed to fit perfectly and serve food with ice, nitrogen or dry ice mist and cold smoke.



## Caja marisco impresa Seafood Printed Box

100/2000 1K 21 x 13 cm Altura / Height: 5 cm 8 uds pcs

100/2004 2K 30 x 20 cm Altura / Height: 8.5 cm 5 uds pcs

100/2005 3K 40 x 30 cm Altura / Height: 7 cm 3 uds pcs

Caja impresa en español e inglés / Box printed in Spanish and English



130/0010

Spray polvo - Cabezal Oro  
Powder Spray - Gold Head

10 uds  
pcs

Muy útil para cappuccino, bombonería, emplatados muy precisos y delicados de esencias en polvo mezcladas con maltodextrinas, etc.  
¡Pruebe a espolvorear el algodón de azúcar mientras lo enrolla!

Very useful for cappuccino, bonbons, very precise and delicate plating of powdered essences mixed with maltodextrins, etc.  
Try sprinkling the cotton candy while rolling!



PC/65402  
Mini Spray

24 uds  
pcs

Ø 2 cm



10 cm

15 ml

100/0002  
Paella Party

100 uds  
pcs

Ø 2 cm





PC/65310

Vasito recto de doble pared  
Straight Double Wall Mini Glass

30 ml

Ø 5,5 cm  
Altura / Height: 5,5 cm

PC/65300  
Mini tetera  
Mini Teapot

150 ml

Filtro vidrio  
Glass filter



13 cm

5 cm



PC/65307

Mini campana  
con base  
Display stand  
with mini cloche

Ø 8 cm  
Altura / Height: 17 cm



235 uds  
pcs

100/1001  
Lata aluminio oval con tapa  
Oval aluminium cans with lid

120 ml

11 x 7 x 3 cm

100 uds  
pcs

100/1002  
Lata aluminio oval con tapa  
Oval aluminium cans with lid

120 ml

11 x 7 x 3 cm

100 uds  
pcs

100/0057  
Lata aluminio rectangular con tapa  
Rectangle aluminium cans with lid

60 ml

11 x 5.5 x 2 cm



100 uds  
pcs

100/1041  
Lata aluminio redonda con tapa  
Round aluminium cans with lid

88 ml

Ø 7.15 cm Altura / Height: 2.8 cm

100 uds  
pcs

100/1043  
Plato Tapa aluminio  
Plate Tapa aluminium

Ø 8 cm

## LATAS DEGUSTACIÓN TASTING CANS

Latas de conserva vacías con tapa abre fácil separada, ideal para presentar raciones de alimentos frescos como simul de producto en conserva.

Estos envases son para uso exclusivo como plato degustación.

Empty preserve cans with lid. Ideal to present portions of fresh food as if it were canned. These cans can be used only for food presentation.



Práctico sistema de cerrado con el cierralatas manual Ref. 100/0055  
Easy closing system with the manual can sealer Ref. 10070055



100/1042

Lata bowl aluminio con tapa  
Bowl aluminium can with lid

100 uds  
pcs

150 ml

Ø 11 cm Altura / Height: 3.5 cm



100/1006

Lata hojalata redonda con tapa XS  
Round tin can with lid

100 uds  
pcs

120 ml

Ø 11 cm Altura / Height: 2.2 cm



Práctico sistema de cerrado  
con el cierralatas manual  
gigante - Ref. 100/1000  
Easy closing system with the  
giant manual can sealer  
Ref. 100/1000



100/1005

Lata hojalata redonda con tapa XL  
Round tin can with lid

50 uds  
pcs

280 ml

Ø 12,5 cm  
Altura / Height: 3 cm





Para latas redondas  
de Ø 8 cm (100/1041)  
For round cans  
of Ø 8 cm (100/1041)

**100/0055**  
Cierralatas redondas manual  
Manual round can sealer



MODELOS  
PATENTADOS  
PATENTED  
MODELS



**100/1000**  
Cierralatas manual gigante  
Giant manual can sealer



Para latas redondas  
de Ø 11 cm (100/1042, 100/1006)  
For round cans  
of Ø 11 cm (100/1042, 100/1006)

100/0186

Mini lata Olivas redonda con tapa  
Mini round tin can with lid

60 uds  
pcs

250 ml

Ø 7 cm  
Altura / Height: 7 cm



100/0187

Lata Popeye hojalata con tapa  
Popeye tin can with lid

36 uds  
pcs

400 ml

Ø 7.9 cm  
Altura / Height: 11 cm



Práctico sistema de cerrado  
con el cierralatas manual  
Ref. 100/0055  
Easy closing system with  
the manual can sealer  
Ref. 100/0055



Cierralatas redondas  
Round can sealer

**YouCook**



## ALUMINIUM CAN SEALER “Bronson”

Selladora para latas de aluminio “Slim”

Aluminum “Slim” can sealing machine

La solución ideal para sellar latas Slim de aluminio con rapidez y estilo.

Su sistema de rotación controlada garantiza un sellado firme en tan solo 5 segundos, permitiendo alcanzar una producción de más de **400 latas por hora** con solo pulsar un botón.

Diseñada específicamente para bebidas líquidas, con o sin gas. Perfecta para **refrescos, cervezas, bebidas energéticas, jugos, té o infusiones.**

BRONSON asegura un cierre uniforme y aporta un acabado profesional y consistente.

Compacta, eficiente y 100% enfocada en bebidas. La selladora BRONSON convierte tu producto en una experiencia visual y comercial irresistible.

The ideal solution for sealing **Slim** aluminum cans quickly and stylishly.

Its controlled rotation system ensures a firm seal in just 5 seconds, enabling production of over 400 cans per hour with the push of a button.

Designed specifically for carbonated or non-carbonated liquid beverages. It's perfect for sodas, beer, energy drinks, juices, teas, or infusions.

BRONSON guarantees a uniform seal and delivers a professional and consistent finish.

Compact, efficient, and 100% focused on beverages, the BRONSON sealer turns your product into an irresistible visual and commercial experience.

100/1061

Cierralatas automático latas de aluminio - 230 V

Automatic can opener for aluminum cans - 230 V

20 x 37 x 67 cm



Inspírate para tus presentaciones  
Get inspired for your presentations

YouCook



Latas aluminio Slim 200 ml  
Slim 200 ml aluminum can

75 uds  
pcs

100/1063

200 ml Ø 5,5 cm Alt / Height: 11 cm

Incluyen tapas *soda slim* de aluminio  
Includes slim aluminum soda lids

Latas aluminio Slim 250 ml  
Slim 250 ml aluminum can

70 uds  
pcs

100/1064

250 ml Ø 5,5 cm Alt / Height: 13,5 cm

Incluyen tapas *soda slim* de aluminio  
Includes slim aluminum soda lids



Personalización  
Customization

Las latas se pueden personalizar por completo, lo que potencia la imagen de tu marca con diseños llamativos y únicos. Son ideales para emprendedores, bares, cafeterías, festivales y marcas que buscan destacar.

The cans can be fully customized, boosting your brand image with eye-catching and unique designs. Ideal for entrepreneurs, bars, cafés, festivals, and brands looking to stand out.

## SODA CAN SEALER **Pro**

Selladora de latas eat & drink

Eat & drink can sealer

Esta nueva selladora de latas PET automática, está diseñada para evitar cualquier efecto centrífugo en el interior de las latas. Gracias a sus cabezales móviles, podrá sellar más de 400 latas por hora sin alterar el producto interior.

Con un contador digital de producción, lo que facilita el control del negocio en tiempo real. Las latas son completamente personalizables mediante stickers de vinilo o envoltorios termorretráctil.

This new automatic PET can sealer is designed to prevent any centrifugal effect inside the cans. Thanks to its mobile sealing heads, it can seal over 400 cans per hour without affecting the contents.

A digital production counter, making real-time business tracking easier. The cans are fully customizable with vinyl stickers or shrink-wrap labels.

### Soda can sealer Pro

100/1048

220 V

100/1050

110 V

40 x 22 x 60 cm

Puede cerrar 3 tamaños de lata: 250ml - 330ml - 500ml

It can seal three can sizes: 250ml – 330ml – 500ml



Descubre Can Sealer Pro  
Discover Can Sealer Pro

**YouCook**



**BEBIDAS CON GAS**  
CARBONATED DRINKS

**BEBIDAS CON HIELO**  
DRINKS WITH ICE

**BEBIDAS CON FRUTA**  
DRINKS WITH FRUIT

**POSTRES**  
DESSERTS

**CREMAS**  
CREAMS

**HELADOS**  
ICE CREAMS

**SNACKS**

**MACEDONIAS**  
FRUIT SALADS



Ideal para cáterings, buffets, hoteles, discotecas, heladerías, franquicias, y más. ¡Un producto, múltiples posibilidades de negocio!

Para quienes desean agregar valor a sus ofertas, o para emprendedores que buscan un concepto innovador de venta directa.

Ideal for catering services, buffets, hotels, nightclubs, ice cream shops, franchises, and more. One product, countless business opportunities!

For those looking to add value to their offerings, as for entrepreneurs seeking an innovative direct-to-consumer concept.



## ESCOGE TU LATA CHOOSE YOUR CAN



PERSONALIZABLES  
CUSTOMIZABLES

Stickers de vinilo o envoltorios termorretráctiles.  
Harán de cada lata una extensión de tu marca.

Vinyl stickers or shrink sleeves.  
They'll turn every can into an extension of your brand.



## SELECCIONA TU TAPA SELECT YOUR LID



¡Y SELLA TUS PRODUCTOS!  
& SEAL YOUR PRODUCTS!

¡LATAS 100% RECICLABLES!  
¡100% RECYCLABLE CANS!



Latas Soda PET /  
Soda Can PET



100/1044	250 ml	Ø 6,5 cm	Alt / Height: 9,5 cm
100/1045	330 ml	Ø 6,5 cm	Alt / Height: 11,5 cm
100/1058	500 ml	Ø 6,5 cm	Alt / Height: 17 cm

Tapas no incluidas / Lids are not included

Resistentes entre -20 a 50 °C. Se deben llenar siempre en frío  
Resistant from -20 to 50 °C. They should always be filled cold



Tapas Peel Off para latas PET  
(para modelos Bronson y Pro)

Peel Off lids for PET cans  
(for Bronson & Pro models)

100 uds  
pcs

100/1049 Aluminio / Aluminium

Tapas Soda para latas PET  
(para modelos Bronson y Pro)

Soda lids for PET cans  
(for Bronson & Pro model)

100 uds  
pcs

100/1051 Aluminio / Aluminium

100/1066 Negra / Black

## Sella latas PET manualmente

Seal PET cans manually

Cierra tus latas PET de forma segura, y conserva la calidad y el sabor de todas tus preparaciones.

Close your PET cans securely and preserve the quality and flavor of all your preparations.



30/3036

Cierralatas PET manual Peel Off  
Manual PET Peel Off can sealer



30/035

Cierralatas PET manual Soda (color plata)  
Manual PET Soda can sealer (silver colour)



Usado de cierralatas manual peel-off  
Manual can sealer for peel-off lids

**YouCook**



Usado de cierralatas manual para tapas soda  
Manual can sealer for soda lids

**YouCook**

## Tubos de aluminio

Aluminium tubes

Mini tubos de aluminio desechables con aplicador, ideal para rellenar con mieles aromatizadas, cremas, jugos espesos, mahonesas creativas y salsas. De fácil y rápido relleno permite servir monodosis en cualquier catering o aperitivo. Cuentan con varios tamaños, colores y tapones.

Mini disposable aluminium tubes with applicator, perfect for filling with aromatized honeys, creams, thick juices, creative mayonaises and sauces. Easy to fill, they offer possibility to serve single doses in any catering. It counts with different sizes, colours, shapes and caps.

### TUBOS ALUMINIO ALUMINIUM TUBES

100 uds  
pcs

90/0001	Blanco · White	7 ml
90/0014	Plata · Silver	
90/0015	Cobre · Copper	
90/0020	Negro · Black	15 ml
90/0005	Blanco · White	
90/0016	Plata · Silver	
90/0017	Cobre · Copper	
90/0021	Negro · Black	30 ml
90/0002	Blanco · White	
90/0018	Plata · Silver	
90/0019	Cobre · Copper	



PERSONALIZABLES  
CUSTOMIZABLES



Conoce más  
Learn more

YouCook





# Chapa tubos

catalogue 8 | [www.100x100chef.com](http://www.100x100chef.com)

90/0011

CHAPA TUBOS

Pinza para cerrar tubos de aluminio

Aluminium Tube Crimper Pliers



## Tubo Striped

Striped tube

Tubo de aluminio blanco, laminado y flexible, diseñado para presentaciones originales en cocina o coctelería.

Su boquilla permite combinar diferentes mezclas y generar diferentes efectos visuales al salir, imitando el aspecto de una pasta de dientes.

¡Sorprende a tus comensales con una forma de presentar diferente y divertida!

White aluminum tube, laminated and flexible, designed for original presentations in gastronomy or mixology.

Its nozzle allows different mixtures to be combined, creating eye-catching visual effects as they're dispensed, resembling toothpaste.

Surprise your guests with a fun and unexpected way to serve!

90/1001  
Tubo Striped  
Striped tube

50 uds  
pcs

30 x 20 cm  
Alt / Height: 15,5 cm



Descubre cómo usarlo  
Discover how to use it

**YouCook**



1. Rellenar hasta el nivel del cuello central , sin sobrepasarlo  
1. Fill to the level of the center neck, without exceeding it



2. Completar con el preparado que actuará de base, llenando el resto del tubo  
2. Fill the rest of the tube with the preparation that will act as a base.



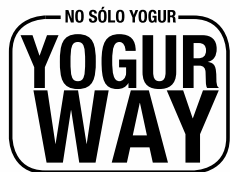

Cierre sus envases de yogurt con un toque de calor en un segundo.  
Close your yogurt pots with a touch of heat in just a second.



Bote vidrio yogurt  
Yogurt glass pot

100/0083 106 uds pcs 120 ml



TAPA TERMOSELLABLE  
THERMO-SEALABLE LIDS

100/0007	Blanca / White	750 uds pcs
100/0136	Oro / Gold	600 uds pcs
100/0137	Plata / Silver	

Ø 6.2 cm



BOTES Y TAPAS  
PERSONALIZABLES  
CUSTOMIZABLE POTS  
AND COVERS



Cierra y personaliza tus botes  
Seal and customize your pots

**YouCook**



# JUMBO

50 uds  
pcs

100/0084

Bote Yogur Jumbo  
Jumbo yogurt glass pots

360 ml

Ø 8 x 10 cm



100/0056  
Logo Relief



100/0040  
Mini-print



100/0001  
Cuajada  
Ceramic Curd Pot

35 uds  
pcs

150 ml

Ø 7 cm Alt / Height: 8 cm

100/0053

Tapa termosellable blanca XL  
para Yogur de 400 ml y Cuajada  
White Thermo-sealable lid XL  
for 400 ml Yogurt & Curd pot

750 uds  
pcs

Para ref. / For ref.  
100/0052 & 100/0040

Ø 8 cm

# GIN TONIC CONCEPT

El Gin Tonic lo haces tú!  
Gin Tonic made by you!



100/0073  
Botella cristal  
Glass bottle

24 uds  
pcs

200 ml

Ø 5 cm  
Altura / Height: 18 cm



Corona chapas  
Crown bottle caps

100 uds  
pcs

100/0075	Oro · Gold	100/0077	Rojo · Red
100/0076	Verde · Green	100/0078	Plata · Silver





**100/0142**  
 Prensa Cierra Botellas  
 Corcho y Corona  
 Sealing Press For Bottles  
 With Corks And Caps



**100/0143**  
 Tapon Corcho Cava  
 Corks for Champagne Bottle

50 uds  
 pcs

Corona champagne  
 Champagne Muselet

100 uds  
 pcs

100/0147 Negro · Black

100/0148 Plata · Silver



**100/0144**  
 Cerrador de Bozales  
 Muselet Closer



**100/0145**  
 Cepillo limpia botellas  
 Bottle Cleaning Brush



# CHAMPAGNE CONCEPT

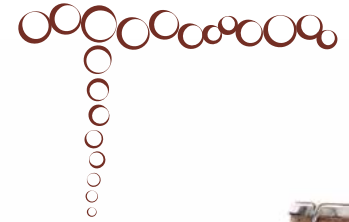

**100/0141**  
 1/2 Botella Spumanti  
 1/2 Spumanti Bottle

6 uds  
 pcs

500 ml

Ø 5.5 cm  
 Altura / Height: 25 cm



LAVABLE  
 WASHABLE



PERSONALIZABLES  
 CUSTOMIZABLES



100/0096  
Botella de leche miniatura  
Milk Bottle Miniature

36 uds  
pcs

40 ml

Ø 3 cm Alt / Height: 9 cm

160/5098  
Pajitas Ambar  
Ambar Straws

24 uds  
pcs

Ø 0,8 cm  
Alt / Height: 21 cm



160/5100  
Droppers

24 uds  
pcs

50 ml

Ø 3,5 cm  
Alt / Height: 12 cm

160/5097  
Botella Ambar  
Ambar Bottle

24 uds  
pcs

250 ml

Ø 6,5 cm  
Alt / Height: 13 cm



PERSONALIZABLES  
CUSTOMIZABLES



30 ml



Tarro confitura mini  
Mini jam jar

105 uds  
pcs

100/0115 Oro / Gold

100/0116 Negro / Black

Ø 4,5 cm

160/5003  
Petaca SpeakEasy  
SpeakEasy Hip Flask

24 uds  
pcs

200 ml

8 cm x 5 cm Alt / Height: 15 cm



160/5099  
Mini Petaca SpeakEasy  
SpeakEasy Hip Flask

24 uds  
pcs

100 ml

3 cm x 6,5 cm Alt / Height: 13 cm

## BAGAZO

Nuestra línea de vajilla ecológica está fabricada con bagazo de caña de azúcar, un material natural, biodegradable y completamente compostable. Elegante, resistente y versátil, es la alternativa más sostenible a los platos desechables tradicionales.

Soporta líquidos, puede usarse en horno y microondas hasta 190 °C, y se descompone en menos de seis meses, sin generar residuos ni contaminación: al contrario, enriquece la tierra como abono.

Disponible en una amplia variedad de formatos, esta vajilla es perfecta para servicios en establecimientos HORECA: restaurantes de comida para llevar, food trucks, negocios de street food, fast food o catering.

Sostenible, práctica y con un acabado que transmite calidad, esta colección combina funcionalidad y estilo en cada pieza.



100/0218  
Hoja Bagazo  
Bagasse leaf

100 uds  
pcs

6 x 10 cm  
Alt. / Height: 1 cm



100/0213  
Plato Bagazo  
Bagasse plate

100 uds  
pcs

6 x 6 cm  
Alt. / Height: 1 cm



100/0217  
Limón Bagazo  
Bagasse lemon

100 uds  
pcs

11 x 6 cm  
Alt. / Height: 3 cm



## BAGASSE

Our eco-friendly tableware line is made from sugarcane bagasse, a natural, biodegradable, and fully compostable material. Elegant, durable, and versatile, it's the most sustainable alternative to traditional disposable plates.

Resistant to liquids and suitable for both oven and microwave use up to 190 °C, it decomposes in less than six months without leaving waste or pollution, in fact, it enriches the soil as compost.

Available in a wide range of formats, this tableware is ideal for HORECA businesses: take-away restaurants, food trucks, street food stands, fast-food chains, or catering services.

Sustainable, practical, and refined, this collection combines functionality and style in every piece.

100/0214  
Bol Bagazo  
Bagasse bowl

100 uds  
pcs

10 x 10 cm  
Alt. / Height: 5 cm



100/0216  
Cazo Bagazo  
Bagasse pot

100 uds  
pcs

3 x 9 cm  
Alt. / Height: 5 cm



100/0215  
Sartén Bagazo  
Bagasse pan

100 uds  
pcs

3 x 9 cm  
Alt. / Height: 2 cm





Egg  
Bagazo / Bagasse

100 uds  
pcs

100/0210	XL	20 x 14 cm	Alt / Height: 7,5 cm
100/0211	M	11 x 7 cm	Alt / Height: 3,5 cm
100/0212	S	8 x 5 cm	Alt / Height: 2,2 cm



### Mussel

Bagazo / Bagasse

100 uds  
pcs

100/0220	XS	10 x 4 cm	Alt / Height: 2 cm
100/0221	XL	10 x 5,5 cm	Alt / Height: 2 cm

### 100/0219

Cuchara Arch Bagazo  
Bagasse Arch spoon

100 uds  
pcs

7 x 4 cm  
Alt. / Height: 2 cm

# TAKE AWAY

100 uds pcs  
100/0132  
Cajita Patatas Negra  
Fries Black Box  
10 x 5 cm - Altura / Height: 12 cm

100 uds pcs  
100/0194  
Caja ensaimada mini  
Mini Ensamada Box  
Caja cerrada / Closed box  
12 x 12 cm - Altura / Height: 2.5 cm

100 uds pcs  
100/0222  
Cajita Patatas Negra XS  
XS Fries Black Box  
6 x 3 cm - Altura / Height: 7 cm

100 uds pcs  
100/0197  
Caja pizza mini  
Mini pizza Box  
Dimensiones caja cerrada  
Closed box dimensions  
9 x 9 cm - Altura / Height: 2 cm



PERSONALIZABLES  
CUSTOMIZABLE



100 uds  
pcs

100/0033

Mac Bit blanco / White Mac Bit

100 uds  
pcs

100/0098

Mac Bit negro / Black Mac Bit

Dimensiones caja cerrada

Closed box dimensions

Base: 6 x 7 cm

Centro / Center: 9 x 8 cm

Altura / Height: 5 cm



100 uds  
pcs

100/0034

Noodle Box

Interior plastificado

Dimensiones caja cerrada

Closed box dimensions

Base: 3 x 3 cm

Boca / Aperture: 5 x 5 cm

Altura / Height: 5 cm

100 uds  
pcs

100/0099

Noodle Box with handle

Interior plastificado

Dimensiones caja cerrada

Closed box dimensions

Boca / Aperture: 8 x 6 cm

Altura / Height: 5 cm



# TAKE AWAY

PAPEL DE PERIÓDICO  
NEWSPAPER

Hojas de papel parafinado simil  
periódico, impreso en tintas  
vegetales.

Puedes utilizarlo como envoltorio  
de sandwiches o bocadillos, patatas  
asadas, castañas o combinados con  
nuestras cestas de freidora o cajas  
de madera.

Newspaper print wax paper printed  
with vegetable inks. Use it to wrap  
sandwiches, baked potatoes,  
chestnuts.  
Or combined with our fryer baskets.  
Available in 4 Languages.

500 uds  
pcs  
100/0089  
Cocina de Vanguardia

29 x 30 cm

500 uds  
pcs  
100/0090  
The New Fork Times

500 uds  
pcs  
100/0119  
Food Times



PERSONALIZABLES  
CUSTOMIZABLES  
A PARTIR DE 50.000

# DE VANGUARDIA

Los premios de la Academia Internacional de Gastronomía 2006 abordan el avance tecnológico de la mano de la...

## En busca del mejor sumiller de Galicia

El próximo lunes 17 de  
enero tendrá lugar en  
A Coruña la celebración  
del congreso de



## ¿Quién inventó las patatas fritas?

Francia y Bélgica se disputan la  
invención de las patatas fritas,  
crujientes, salados y sabrosos  
palitos de patata, como producto  
gastronómico del genio nacional,  
pero los verdaderos orígenes  
subyacen en el folklore popular.

EDUARD CANELA  
París



...francófona belga RTBF reavivó  
las papas fritas son  
...historieta" para los franceses,  
...a la revoluc...



All the News  
That's Fit to Print  
VOL. 01 No. 14.675  
**The New York Times**  
NEW YORK SUNDAY, FEBRUARY, 12, 2008

Food and  
Culture  
The Academia  
Barilla Gastronomic  
Library  
Rosalind Hammer  
New York  
The Academia Culinary  
Gastronomy

**Oktoberfest**  
The bigger European  
beer festival of the year

The Munich Beerfest traditionally  
takes place during the sixteen  
days up to and including the first  
Sunday in October. Literally  
millions of people turning up for  
Oktoberfest, Munich becomes a  
very busy place!

**FOOD TIMES**  
Wednesday March 19 2014 | www.foodtimes.co.uk | No 70161  
Max 7C - Min 4C

**Why the  
street food  
is this year's  
hottest trend**

By Richard Johnson  
Source: The Independent (March, 09 2014)  
Huffpost (March 09 2014)

IN my time as a food writer and  
breakfaster I've travelled the  
world. And some of the best food  
I've eaten has been on the streets -  
whether that was in Bethlehem,  
its hole-in-the-wall falafel

better than restaurant food. For a  
start, it's cheap and fresh - rather  
than left standing on a hot plate till  
a scuffy waiter deigns to pick it up -  
but it's also all about offering the  
kind of food we want to eat, not  
some received notion of "good  
food". And its sellers buy local and  
seasonal as a matter of course  
because that's what's cheapest -  
and it's sold so tight that there's

**World's smallest burger menu**

By Richard Johnson  
Source: BuzzFeed (Dec 14 2007)  
THANKS to horecaterers from Crafter.org  
Forums for making the smallest cheeseburger  
in the world! This is a real edible cheeseburger  
made with real miniature buns and complete  
with a micro portion of fries...  
"After we took all the pictures we cut the tiny  
burger in half and each ate half. It tasted  
awesome..." "Our burger was a little over one  
inch tall and about an inch wide. "Everything  
was handmade, including the tiny buns."



**"Liberation Wrapper"**



**"Liberation Wrapper"**

By Erin Moss  
Source: Fox 10 Food  
(Nov 04 2011)  
A national hamburger chain in Japan has created a  
burger wrapper that doubles as a face-mask for  
women. Why? Women weren't buying their girly  
"Classic Burger" because they weren't comfortable  
opening their mouths wide enough to eat the large  
burger. WTF?  
Apparently, the reason women didn't want to feast  
on a delicious, meaty burger was that in Japan, small  
mouths are considered attractive, and it is considered  
proper etiquette to cover your mouth while eating in  
public (if you're a woman, that is). The "Liberation  
burger" must allow it.

**Space food design**

By Roberts Whitehead  
and Tom Hogg  
SPACE food is a variety of food  
products, specially created and  
processed for consumption by  
astronauts in outer space. The food  
has specific requirements of  
providing balanced nutrition for  
individuals working in space, while  
being easy and safe to store, prepare  
and consume in the machine-  
ery-filled low gravity environments  
of manned spacecraft. In recent  
years, space food has been used by  
various nations engaging on space  
programs as a way to share and  
show off their cultural identity and  
facilitate intercultural communi-  
cation.  
i.e., they should store well,  
easily, and leave little waste be-  
hind. Packaging for space food  
the primary purposes of pre-  
and containing the food  
light-weight, easy to dispo-  
useful in the preparation  
of food for consumption  
of label, which allows  
preparation instructions  
English and Russian. Me-  
are packaged in cans and  
These are heated through  
stative (ohmic) method





## PAPEL PARAFINADO WAX PAPER

Nuestros papeles están protegidos por la parte impresa con una capa de parafina, lo que imposibilita el contacto del alimento con la tinta y evita la disolución con el aceite del alimento.

Our papers are protected by a layer of paraffin on the printed side, which prevents food from coming into contact with the ink and prevents it from dissolving in the oil from the food.



## PAPEL PARAFINADO WAX PAPER

500 uds  
pcs

100/0174 Street Food Kraft

29 x 30 cm



## CONOS DE CARTÓN CARDBOARD CONES

100 uds  
pcs

100/0066	Blanco · White	Micro
100/0067	Negro · Black	

100/0043	Blanco · White	XS
100/0105	Negro · Black	
100/0195	Kraft	

100/0044	Blanco · White	XL
100/0108	Negro · Black	
100/0196	Kraft	





## CONOS DE CARTÓN cardboard cones

100 uds  
pcs

100/0068	Micro
100/0091	XS
100/0003	XL
100/0122	XXL



25 cm

20 cm

XXL Ø 12 cm





Pajitas de cartón  
Cardboard straw

100 uds  
pcs

PC/70111	Azul / Blue
PC/70112	Verde / Green
PC/70113	Naranja / Orange
PC/70114	Amarillo / Yellow
PC/70115	Rosa / Pink

Alt. / Height: 19,5 cm



100/1018  
Huevera codorniza 18 huevos  
Quail egg cup for 18 eggs

12 uds  
pcs

15 x 11 cm  
Alt. / Height: 3 cm



Botella Zumo  
Juice bottle

50 uds  
pcs

100/1141	125 ml	4 x 4 x 11 cm
100/1142	250 ml	5 x 5 x 13 cm
100/1143	500 ml	6,5 x 6,5 x 16 cm



100/0230  
Mini Cake Box 100 uds pcs

7 x 7 cm  
Alt. / Height: 7 cm



Caja healdo mini  
Mini ice cream box 100 uds pcs

PC/70814 Rosa / Pink

PC/70815 Naranja / Orange

Ø 5 cm Alt. / Height: 4,5 cm



PC/70811  
Cajita Brownie azul 100 uds pcs  
Blue Brownie box

4 x 4 cm  
Alt. / Height: 6 cm



100/0165  
PopCorn Box 100 uds pcs

5 x 7 cm  
Alt. / Height: 7 cm

100/0198  
Kalippo

100 uds  
100 pcs

Ø 4,5 x 13,5 cm

Incluye 100 tapas termosellables  
Includes 100 heat-sealable lids



PERSONALIZA TUS KALIPPO  
CUSTOMIZE YOUR KALIPPO

# AGAVE STRAW

Biodegradable



Pajitas biodegradables fabricadas con fibras vegetales provenientes del bagazo del ágave, consideradas desecho de la industria tequilera del mezcal, aportando características ideales para la elaboración del bioplástico. 100%reciclables son un aprovechamiento circular de un sobrante no alimentario.

Resistentes a la humedad incluso 24 horas sumergidas en líquidos, ya sean fríos, ácidos o a pleno calor.

Muy probablemente, sea el mejor producto que pueda sustituir verdaderamente las pajitas de plástico.

Realmente económico e ideal para coctelerías, heladerías y todo tipo de bares.

Biodegradable straws made with vegetable fibers from the bagasse of the agave, considered waste from the tequila mezcal industry, providing ideal characteristics for the production of bioplastic.

100% recyclable, a circular use of a non-food waste, resistant to humidity even 24 hours submerged in liquids, cold, acids or high heat. Probably the best product that can truly replace plastic straws.

Really economical for cocktail bars, ice cream shop and all kinds of bars.



Conoce su origen  
Know its origin

YouCook



Frío y calor  
Hot & Cold

Alcoholes  
Alcohol

Ácidos  
Acids

Bebidas cálcicas  
Calcic Drinks

Sin sabor ni color  
No taste, no color

100/0216  
Pajitas Ágave  
Agave straws

150 uds  
pcs

Alt. / Height: 21 cm



## DRINKING BAG

Bolsas de polipropileno bi-orientado transparente con tapón de seguridad, diseñadas para contener y servir todo tipo de bebidas, salsas o caldos, tanto fríos como calientes.

Son resistentes y aptas para la pasteurización, lo que permite conservar los productos de manera segura.

Transparent bi-oriented polypropylene bags with safety caps, designed to contain and serve all types of beverages, sauces, or broths, both hot and cold.

They are durable and suitable for pasteurization, allowing products to be stored safely.

100/0170  
Drink bag  
325 ml

100 uds  
pcs



## BOLSA COCKTAIL COCKTAIL BAG

Bolsas de polipropileno transparente bi-orientadas con fuelle y fondo cuadrado plano.

Aptas para todo uso alimentario, totalmente estancas y resistentes a cualquier manipulación, contención de líquidos incluso alcalinos y ácidos.

Muy resistente al calor y al frío.

Polypropylene bi-oriented bags with fold and plain square bottom.

Suitable for any food connected use. Fully waterproof and resistant to any manipulation and liquids, including alkaline and acid liquids.

Also very resistant to heat and cold.



PERSONALIZABLES  
CUSTOMIZABLES



100/0150 8 x 5 cm - Altura / Height: 24 cm

100 uds  
pcs

100/0152 6 x 5 cm - Altura / Height: 17 cm

100/0151 8 x 5 cm - Altura / Height: 24 cm

1000 uds  
pcs

100/0153 6 x 5 cm - Altura / Height: 17 cm



Rotulables  
Writable

100 uds  
pcs

PC/68549

Brocheta Pizarra / BlackBoard Skewer / 15 cm  
pizarra / slate board: 5 x 3.5 cm

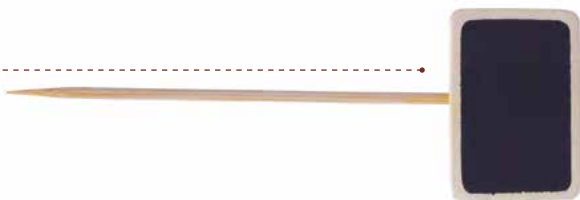

100 uds  
pcs

PC/68558

Brocheta Twister / Twister Skewer / 12.5 cm



100 uds  
pcs

PC/68559

Brocheta Ying-Yang  
Ying-Yang Skewer  
11.5 cm

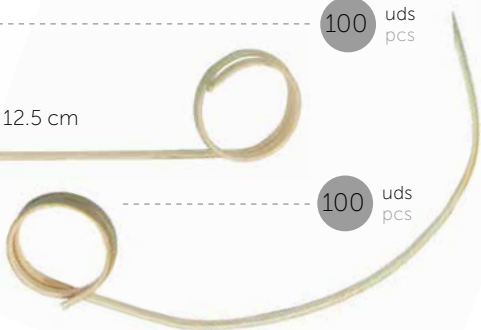

100 uds  
pcs

Brocheta Noshi / Noshi Skewer

PC/68535

18 cm

Brocheta Teppo / Teppo Skewer

PC/68540

18 cm



PERSONALIZABLES  
CUSTOMIZABLES

500 uds  
pcs

150/0006

Palito polo  
Popsicle Wood Stick

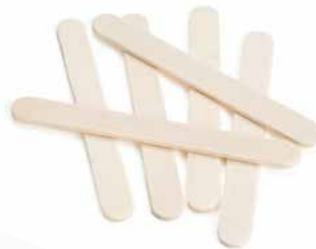

500 uds  
pcs

150/0007

Palito bombón helado  
Ice Cream Wood Stick



500 uds  
pcs



150/0008

Palito mini bombón helado  
Mini Ice Cream Wood Stick



100 uds  
pcs



**PC/68516**  
Vasito pequeño bambú  
Small bamboo cup  
Ø 4.5 cm  
Alt / Height: 4.5 cm

100 uds  
pcs

**PC/68511**  
Barquita pequeña bambú / Small bamboo tray  
7.5 x 4 cm Alt / Height: 1 cm



100 uds  
pcs

**PC/68675**  
Cuchara bambú  
Bamboo Spoon / 10 cm



**Cono bambú**  
Bamboo Cone

100 uds  
pcs

**PC/68500**  
Grande / Big  
Ø 8 cm  
Alt / Height: 12.5 - 16.5 cm

**PC/68502**  
Pequeño / Small  
Ø 4.5 cm  
Alt / Height: 6 - 8.5 cm



*"Técnica, precisión y aroma"*

*"Technique, precision, and aroma"*



# BBQ

KASAI ..... 475

Inspiradas en las barbacoas de cerámica Konro japonesas  
Inspired by Japanese Konro ceramic barbecues

MINI ..... 483

Parrillas de sobremesa  
Tabletop grills

CARBÓN / CHARCOAL ..... 484



## BARBACOAS KASAI KASAI BARBECUES

Viaje a las calles de Osaka con esta **versión profesional mejorada** de las típicas **barbacoas de cerámica Konro** japonesas. Construidas con estructura reforzada de acero inoxidable, chasis compacto y robusto, están revestidas de vermiculita, un mineral natural **muy ligero** que se caracteriza por su capacidad de **retención del calor**, logrando temperaturas de hasta 1.200°C / 2.200°F más estables e intensas.

Gracias su efecto aislante, este material permite que el carbón arda por más tiempo sin producir fugas.

Son extremadamente ligeras, lo que las hace fácilmente transportables y ágiles de manejar, siendo perfectas para su instalación en cualquier cocina, buffet o catering.

Disponemos de diferentes tamaños y accesorios para sacarle el máximo partido.

Take a journey to the streets of Osaka with this **upgraded professional version** of the typical **japanese Konro ceramic barbecues**. Constructed with a reinforced stainless steel structure and a compact, sturdy chassis, they are coated with vermiculite, a natural mineral known for its **lightweight and heat retention properties**, achieving more stable and intense temperatures of up to 1,200°C / 2,200°F.

Thanks to its insulating effect, this material allows the charcoal to burn for longer periods of time without producing leaks.

They are extremely lightweight, making them easy to transport and handle, making them perfect for installation in any kitchen, buffet, or catering service.

We offer different sizes and accessories to make the most of this natural cooking method.

Todos los modelos incluyen **malla Konro grill**.  
*Cooking mesh Konro grill is included.*

180/0011  
BBQ Kasai medium

46,5 x 35,5 cm  
Alt. / Height: 21 cm



180/0010  
BBQ Kasai small

40,5 x 26,5 cm  
Alt. / Height: 21 cm



180/0009  
BBQ Kasai nano

No incluye la base aislante de vermiculita  
Vermiculite insulating base is not included  
31 x 23 cm Alt. / Height: 16,5 cm



180/0012

BBQ Kasai large

70 x 26 cm

Alt. / Height: 21 cm

107°C  
hasta / to  
350°C

Malla Konro grill

Cooking mesh Konro grill

Acero inoxidable cepillado

Brushed stainless steel

Ranuras de ventilación deslizantes

Sliding air vents

Asas de acero inoxidable

Stainless steel handles

Vermiculita (ladrillo refractario)

Vermiculite (fire brick)

## ACCESORIOS KASAI

Si creías que tu konro Kasai era solo un concepto, ¡estabas equivocado!

Complémntala con las planchas Kasai 50:50. Elaboradas con acero inoxidable y con una temperatura de trabajo de 107°C a 350°C, son el complemento ideal para asar carnes, pescados, verduras o terminar un plato cocinado al vacío.



## KASAI ACCESSORIES

If you thought your Kasai Konro was just a concept, think again!

Complete it with Kasai 50:50 griddles. Made of stainless steel, they have a working temperature of between 107°C and 350°C, making them ideal for grilling meat, fish and vegetables, or finishing a sous vide dish.

### Plancha y parrilla Griddle & grill

180/0016	Nano	35 x 24 x 7 cm
180/0017	Small	40 x 24 x 7 cm
180/0018	Medium	47 x 30 x 8 cm



## BROCHETAS / SKEWERS

El soporte de brochetas permite cocinar sin necesidad de levantar las brochetas para girarlas. Una vez encajadas se pueden girar 360° para asegurar una cocción uniforme.

The skewer holder allows you to cook without having to lift the skewers to turn them. Once inserted, they can be rotated 360° to ensure even cooking.

### Soporte con brochetas Skewers rack with sowsrds

180/0028 Nano 35 x 24 x 2 cm

180/0029 Small 40 x 24 x 2 cm

180/0030 Medium 47 x 30 x 2 cm

180/0031 Large 68 x 25 x 2 cm

6 Brochetas  
Skewers

12 Brochetas  
Skewers

### Brochetas Kasai Kasai skewers

180/0032 Short 33 x 1,8 cm

180/0033 Long 44 x 1,8 cm



## PARRILLA / SEARING GRID

Fabricada con tubos de acero macizo de 10 mm de grosor, que garantizan durabilidad incluso bajo uso intensivo, esta parrilla está diseñada para alcanzar altas temperaturas con rapidez y mantener el calor de forma constante. Ideal para sellar cortes grandes de carne con un marcado perfecto, al estilo *robatayaki*.

Made from solid 10 mm steel tubes that ensure durability even under heavy use, this grill is designed to reach high temperatures quickly and retain heat consistently. Ideal for searing large cuts of meat with a perfect char, in true *robatayaki* style.

## Parilla Searing grid

180/0034	Nano	18 x 28 x 3 cm
180/0035	Small	21 x 39 x 3 cm
180/0036	Medium	30 x 43 x 3 cm
180/0037	Large	21 x 67 x 3 cm





## ROBATA KASAI

Fabricada con soportes firmes y compactos, esta estructura ofrece 6 niveles de altura para poder jugar con la distancia respecto al fuego para asar, mantener caliente o cocinar lentamente, todo al mismo tiempo. Una solución versátil y eficiente inspirada en técnicas japonesas de cocción en varios niveles.

Built with sturdy, compact supports, this metal rack features 6 adjustable height levels and it lets you manage distance from the heat source to grill, keep warm, or slow-cook simultaneously. A smart and efficient solution inspired by Japanese multi-tier cooking techniques.

## Parilla robata y 2 mallas Robata rack & 2 meshes

180/0039	Nano	31 x 23 x 36 cm
180/0040	Small	41 x 27 x 36 cm
180/0041	Medium	47 x 36 x 36 cm
180/0042	Large	70 x 37 x 27 cm

## BASE AISLANTE HEAT MAT

Protege cualquier superficie del calor generado por tu barbacoa Kasai gracias a la composición ignífuga y aislante de la vermiculita.

Protect any surface from the heat generated by your Kasai barbecue thanks to the fireproof and insulating composition of the vermiculite.

## Base aislante de vermiculita Vermiculite heat mat

180/0023	Nano	31 x 23 x 2 cm
180/0024	Small	40 x 26 x 2 cm
180/0025	Medium	46 x 35 x 2 cm
180/0026	Large	70 x 26 x 2 cm



RECAMBIOS  
REPLACEMENTS

Malla de repuesto  
Spare mesh

180/0019	Nano	31 x 23 x 2 cm
180/0020	Small	40 x 26 x 2 cm
180/0021	Medium	46 x 35 x 2 cm
180/0022	Large	70 x 26 x 2 cm



Kit placas térmicas de reemplazo  
Replacement heating plate kit

180/0045	Nano	33 x 23 x 20 cm
180/0046	Small	46 x 30 x 24 cm
180/0047	Medium	60 x 50 x 29 cm
180/0048	Large	70 x 22 x 15 cm

MINIATURES  
**BBQ**  
MINIATURAS

Acabado de pintura resistente  
al calor hasta 600°C: fácil de  
limpiar y mantener.

Heat-resistant up to 600°C.  
paint finish for an easy  
cleaning and maintainance.



180/0006  
Barbacoa Mini  
Mini Barbecue

16 x 16 cm  
Alt. / Height: 13 cm

180/0003  
Barbacoa de sobremesa  
Tabletop barbecue

25 x 20 cm  
Alt. / Height: 13 cm



180/0004  
Parrilla de sobremesa  
Tabletop barbecue

25 x 20 cm  
Alt. / Height: 11 cm



## CARBÓN / CHARCOAL

# CALIU

El carbón de cáscaras de coco naturales Caliu se presenta en forma de briquetas cúbicas. Es perfecto por su alto poder calorífico estable, de larga duración, sin llama, sin chispas y muy poco humo.

Caliu's natural coconut shell charcoal comes in the form of cubic briquettes. It's perfect due to its high and stable heat output, long-lasting burn time, flameless and sparkless properties, as well as producing very little smoke.



## Carbón / Charcoal Caliu

C10803	Carbón 5 Kg
C10804	Carbón 10 Kg



C10805  
Pastilla de encendido  
Ignitiontablet

24 uds  
pcs

# KASAI

Sumi Bincho está hecho de maderas duras y densas según los métodos de producción tradicionales de la cultura japonesa. Arde a una temperatura más baja y durante periodos más largos que el carbón ordinario. No produce olor, por lo que es ideal para sellar los sabores naturales.

Sumi Bincho is made from dense hardwoods using traditional production methods from Japanese culture. It burns at a lower temperature and for longer periods of time than regular charcoal, and doesn't produce any odors, making it ideal for sealing in natural flavors.



180/0027  
Carbón Sumi Bincho 10 Kg  
Sumi Bincho charcoal 10 Kg



*"Precisión, durabilidad y elegancia en cada detalle"*

*"Precision, durability and elegance in every detail"*

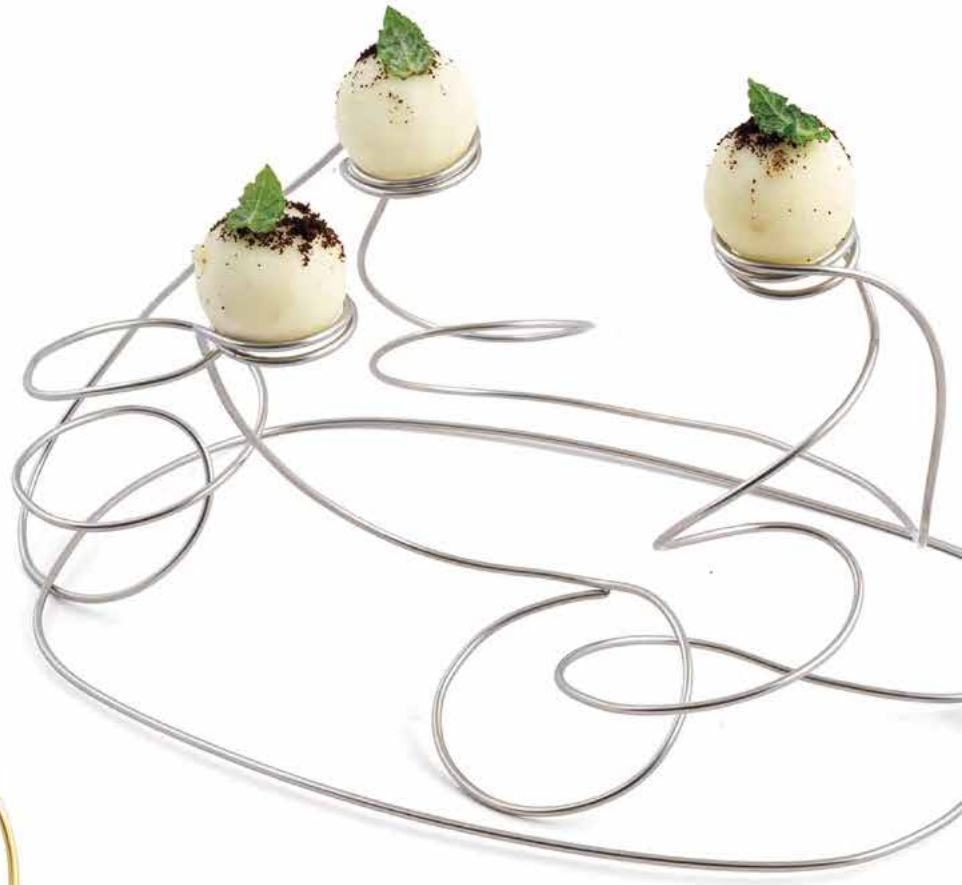



# ICE TWIST DR

Pinzas de hielo by David Ríos

Ice tweezers by David Ríos

Estas elegantes pinzas, diseñadas en colaboración con **David Ríos**, aseguran un **agarre firme y seguro** del hielo, sea cual sea su forma y tamaño.

Ligeras y con un diseño **ergonómico**, aseguran un control de la presión sin castigar las manos con el trabajo diario.

Y con un acabado brillante **antideslizante** y su gravado de piña, símbolo de la hospitalidad, evitan el deslizamiento de los dedos incluso con agua.

Designed in collaboration with **David Ríos**, these elegant tongs provide a firm and **secure grip** of the ice, regardless of its shape or size.

**Lightweight and ergonomically designed**, they enable you to control the pressure applied without straining your hands during daily use.

Featuring a shiny, **non-slip finish** and a pineapple engraving, a symbol of hospitality, they prevent your fingers from slipping, even when wet.

P/64631

Pinzas Ice Twist by David Ríos  
Tweezers Twist by David Ríos

2

uds  
pcs





Firmeza y delicadeza  
Strength and delicacy

Sus **puntas de precisión** sujetan cualquier producto con firmeza permitiendo extraer las esencias de los cítricos con facilidad y sin dañarlos, al igual que colocar guarniciones o decoraciones de forma delicada.

Son ideales para trabajar frente al cliente y generar el *"Twist"* perfecto.

Their **precision tips** hold any product firmly in place, allowing you to extract the essence of citrus fruits easily and without damaging them, as well as delicately placing garnishes or decorations.

They are ideal for working in front of customers and creating the perfect *"Twist"*.



Muelle de alta calidad que no pierde elasticidad ni rigidez con el trabajo diario

A high-quality spring that retains its elasticity and rigidity even after daily use

Ergonomía y comodidad

Ergonomics and comfort

Apertura de 7 cm apta para hielos de gran tamaño y de diferentes formas

7 cm opening, suitable for large ice cubes of different shapes

Punta de precisión para un agarre perfecto

Precision tip for a perfect grip



Presentación Ice Twist  
Ice Twist presentation

YouCook

# WHIPPER & MUDDLE

Dos funciones en una sola herramienta  
Dual-action in one tool

David Ríos nos presenta un accesorio imprescindible de mixología: por un lado aplasta y extrae lo mejor de cada producto y por el otro emulsiona y monta incorporando aire en las mezclas antes de su servicio.

Compacto, fácil de limpiar y diseñado para usar con elegancia en frente de nuestro cliente.

David Ríos presents an essential mixology accessory: on one side, it crushes and extracts the best from each product, and on the other, it emulsifies and whips, incorporating air into the mixtures before serving.

Compact, easy to clean, and designed to be used elegantly in front of our customers.

P/64632  
Whipper & Muddle



P/44020  
Pinza degustación  
Tasting tong

20 cm



Pinza cangrejo  
Crab tong

P/44017 15 cm

P/44018 20 cm



MAX PRECISION



PERSONALIZABLE  
CUSTOMIZABLE

P/34043-W\*  
Pinza Sushi Lacado Blanco  
White Lacquered Sushi Tongs

20 cm



Acabado brillo  
Glossy finish

P/34036-MB\*  
Pinza Sushi Lacado Negro Mate  
Black Lacquered Mate Sushi Tongs

20 cm



Teflon Non-Stick

P/34045 Sushi Non-Stick

P/34044 Sushi MB Non-Stick

Acabado satinado  
Satin finish



## Fantasy\*

P/34105

Gris / Grey

20 cm

Acabado mate  
Color degradado  
Matte finish  
Gradient color



CREA TU PINZA ESPECIAL

MAKE YOUR SPECIAL TONGS



Solid Color Matte Finish\* 20 cm

P/34100

Bourdeos / Burgundy

P/34101

Mandarina / Tangerine

P/34036-MC

Negro / Black



## SPECIAL BARMAN

Pinza Barman Titanium  
Barman Titanium tong  
30 cm

P/34016-G | P/34016-C | P/34016-N  
Dorada / Gold | Cobre / Copper | Negro / Black

## P/34016

Pinza larga Chef  
Chef's long serving tong  
30 cm

P/34015 | P/34014 | P/34012  
25 cm | 20 cm | 16 cm



PERSONALIZABLE  
CUSTOMIZABLE



Saber más en / Know more on:  
[www.100x100barman.com](http://www.100x100barman.com)

**100% Barman**

## P/44014

Pinza Larga Retail 20 cm  
Retail Serving Long Tongs



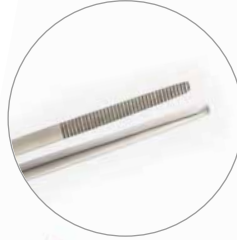

Punta en forma de diamante con interior serrado pulido

Diamond-shaped tip with serrated grip  
Matte finish

P/54037  
Pinza ELITE Sushi Giant  
ELITE Sushi Giant tong

30 cm



## "ELITE" PINZAS RECTAS CHEF SERVING TONGS

### Pinzas ELITE ELITE Chef Serving Tongs

Fabricadas en acero inoxidable AISI 316, la mejor calidad posible de acero inoxidable para uso alimentario. Diseño especial para emplatado, que permite aún más efectividad y precisión, juntando comodidad y delicadeza. Brazos con acabado antideslizante y ergonómico.

Made with AISI 316, the best stainless steel alloy for food contact. Specially designed for creative plating, to ensure effectivity and precision, it allies comfort and delicacy. Arms with ergonomic and non-slip handles.

P/54012  
16 cm



P/54014  
20 cm



P/54016  
30 cm



## Pinzas Sushi Titanio-Color Titanium color Sushi Tongs

Las pinzas de emplatado más vendidas del momento, acabadas con un baño de titanio coloreado en 5 colores inalterables. El titanio confiere la dureza y resistencia necesaria exigida para el uso profesional diario.

The most popular plating tongs of the moment, titanium plated in 5 unalterable colors. Titanium plating gives it the hardness and resistance needed for daily professional use.

P/34043-N	Negro / Black	20 cm
P/34043-P	Púrpura / Purple	
P/34043-B	Azul / Blue	
P/34043-C	Bronce / Bronze	
P/34043-G	Dorado / Golden	

P/34007-N	Negro / Black	14 cm
P/34007-P	Púrpura / Purple	
P/34007-B	Azul / Blue	
P/34007-C	Bronce / Bronze	
P/34007-G	Dorado / Golden	

P/84036  
Pinza Sushi GOLD  
GOLD Sushi tongs

20 cm



P/34043  
Pinza Sushi Titanium  
Titanium Sushi Tong

20 cm

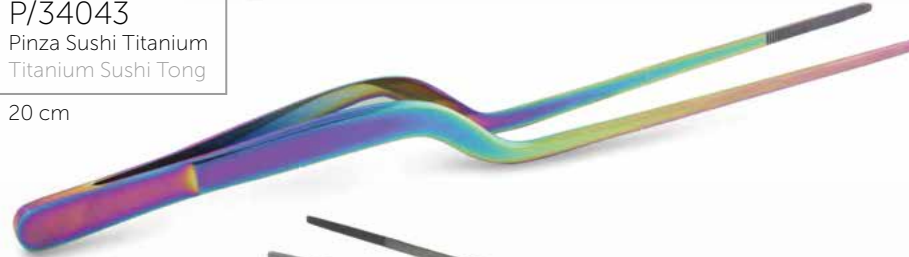

P/64255  
Soporte inox para pinzas Sushi  
Stainless Steel Stand for Sushi Tongs



P/44036  
Pinza Sushi Retail  
Retail Sushi Tongs

Pinza Sushi & Sashimi  
Sushi & Sashimi Tongs

P/34007 | 14 cm

P/34043 | 20 cm



PERSONALIZABLE  
CUSTOMIZABLE





## Kit de emplatado Top Chef *Signature* Top Chef *Signature* Plating set

Incluye:

- Pinza "SUSHI" 20 cm
- Cuchara de degustación y pinza 20 cm
- Espátula de emplatado flexible 20 cm
- Perfect quenelle (quenelle 5 cm) 20 cm
- Plumilla para diseño con salsa 20 cm
- Espátula dosificadora de polvos y cremas 16 cm

Includes:

- "SUSHI" tongs 20 cm
- Tasting spoon and tongs 20 cm
- Flexible plating spatula 20 cm
- Perfect quenelle (quenelle 5 cm) 20 cm
- Sauce design nib 20 cm
- Powder and cream dosing spatula 16 cm

Top Chef *Signature*

P/64050

Dorado / Gold

P/64051

Negro / Black



P/64000

Kit de emplatado Top Chef  
Top Chef Plating Set

Incluye:

- Pinza "KAPABASHI"
- Pinza "SUSHI" 20 cm
- Pinza larga "CHEF" 20 cm
- Espátula flexible 20 cm
- Espátula dosificadora

It includes:

- "KAPABASHI" tongs
- "SUSHI" 20 cm tongs
- Chef's tongs 20 cm
- Flexible 20 cm spatula
- Dosing spatula



## Perfect Quenelle

Elabore perfectas quenelles de helado ya que su simetría así lo permite. Con un mango extremadamente resistente permite trabajar incluso con helados duros. Al ser más grueso de lo normal retiene mejor la temperatura dejando las quenelles mucho más lisas.

Produce perfect ice cream quenelles with exact symmetry. With a highly resistant handle that allows you to work with very hard ice cream. The bowl of the Perfect Quenelle is heavier and thicker than the one of an usual spoon, helping it to retain longer the temperature.

P/64595  
Perfect Quenelle XS  
4 x 2.5 cm

P/64598  
Perfect Quenelle M  
5 x 3 cm

P/64599  
Perfect Quenelle XL  
6 x 4 cm



## Perfect Quenelle Slim

El modelo Slim permite un acabado simétrico y limpio, ideal para presentaciones más estilizadas.

Fabricadas con el mismo mango resistente, garantiza control incluso con masas frías o helados duros, manteniendo su temperatura.

The Slim model allows a symmetrical and clean finish, ideal for more stylized presentations.

Manufactured with the same sturdy handle, it guarantees control even with cold dough or hard ice cream, maintaining its temperature.

P/64633  
Perfect Quenelle Slim M  
5 x 2.5 cm

P/64634  
Perfect Quenelle Slim XL  
6 x 3 cm



P/64502

Rasqueta para emplatar  
Cooking scraper spatula  
17 cm

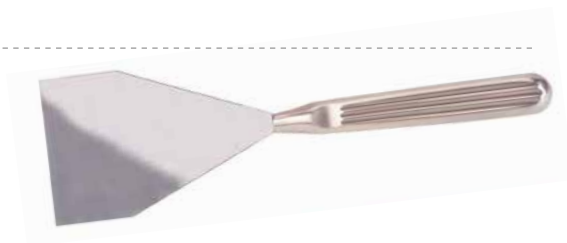

P/64504

Espátula recta / Straight spatula  
19 cm



P/64503

Espátula dosificadora / Dosing mini-spatula  
16 cm



P/64270

Set de espátulas  
Plating spatulas kit

Incluye referencias:  
Includes references:

P/64500  
P/64501  
P/64502



P/64501

Horquilla para emplatar inox / Forked spatula  
19 cm



P/64505

Espátula ancha / Wide spatula  
19 cm

Pala / Spatula:  
13 x 4 cm



P/64500

Espátula para emplatar inox  
Mini flexible serving spatula  
19 cm

Pala / Spatula: 13 x 2 cm



P/64593

Vaciador miniquenelles óvalo  
Oval quenelle baller  
0.5 x 12 cm



P/64594

0.8 x 18 cm

P/64596

Vaciador doble / Double micro-quenelle baller  
Esfera / Sphere Ø 1.2 cm  
Óvalo / Oval: 0.8 cm



P/64597

Estuche 5 vaciadores, surtido  
bolita microquenelle  
5 mini-ball and micro-quenelle  
baller box



Incluye referencias:  
Items included:

- P/64590
- P/64591
- P/64592
- P/64593
- P/64594

P/64590

Vaciador microbolitas  
Miniballer  
Ø 8 mm



P/64591

Ø 12 mm

P/64592

Ø 15 mm



20/0004  
Cuchara Lotus INOX  
Lotus Spoon INOX

10 uds  
pcs



20/2004  
Cuchara Lotus GOLD  
GOLD Lotus Spoon



Baño de oro 14 KT  
14KT Gold coating

20/0011  
Kit cucharas esferificación  
Spherification Spoons Kit



P/34034

Pinza quitaespinas pescado  
Fishbone tweezers  
12 cm



P/34031

Alicate Espinas Pescado  
Fishbone Pliers  
15 cm



P/34040

Pinza quitaespinas Kapabashi  
Kapabashi fishbone tweezers  
12 cm



P/44040

Pinza Quitaespinas Kapabashi Retail  
Retail Kapabashi Fishbone Tongs



P/64110

Rompemariscos con cierre  
Shellfish Cracker  
18 cm

P/64120

Rompemariscos Hostelería  
Shellfish Cracker  
18 cm

Ice Cream Spoon

10 uds  
pcs

P/68023

Mate / Matte

P/68022

Brillante / Glossy

9.5 x 2 cm



12 cm

P/64730

Abridor de huevos  
Hen egg top cutter



P/44730

Abridor de huevos Retail  
Retail Hen Egg Top Cutter



### Labyrinth XS

P/68640 Oro / Gold

P/68641 Plata / Silver

20 x 14 x 10 cm - Ø 2 cm

### Labyrinth XL

P/68642 Oro / Gold

P/68643 Plata / Silver

22 x 15 x 11 cm - Ø 3 cm

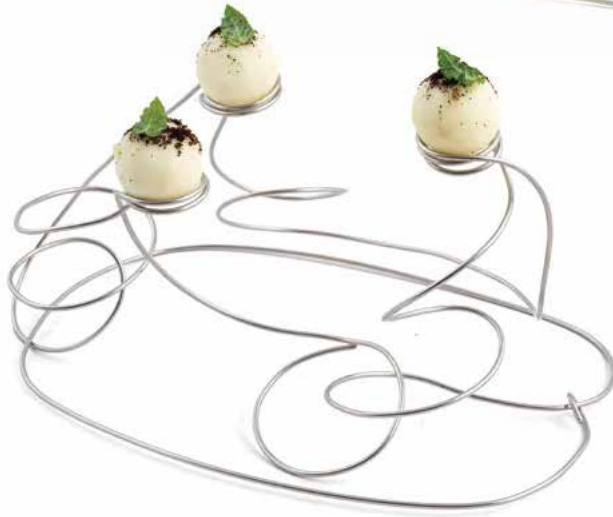



Perfecto para encajar en los soportes de piedra p.141  
Perfect to fit the stones supports p. 141

Loop

P/68644 XS 18 cm

P/68645 XL 24 cm

Ø 5 cm



Tripod

P/68637 Oro / Gold

P/68638 Plata / Silver

P/68639 Negro Mate / Black Matte

7 x 7 x 11.5 cm



Dé un nuevo enfoque a sus presentaciones.  
El soporte trípode es utilizable en 3 diferentes  
posiciones según el producto a exponer.

Give a new approach to your presentations.  
The tripod stand can be used in 3 different positions  
depending on the product to be shown.





P/68647  
Pinza con Soporte para Guarniciones  
Clamp with Garnish Support

*Ideal para pipetas*  
*Perfect with pipettes*



P/68648  
Soporte Guarnición para Copas  
Garnish Glass Support



P/68646  
Pinza con Soporte para Conos  
Clamp with Cone Support



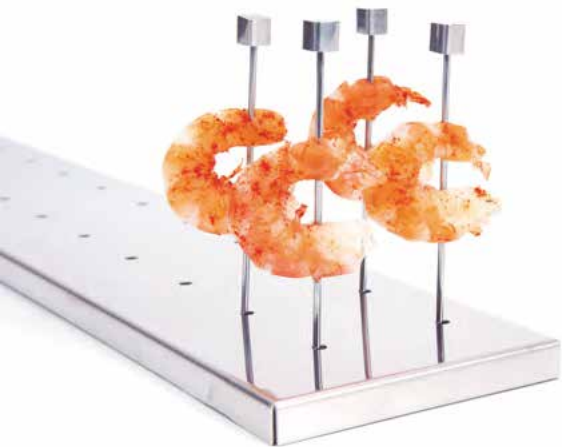

**P/68011**

Plancha inox para 24 brochetas (foam incluido)  
Display board for 24 skewers (foam included)  
49 x 9 x 1 cm



**P/68013**

Foam recambio para plancha inox P/68011  
Spare foam board for display P/68011  
48.9 x 8.9 x 1 cm

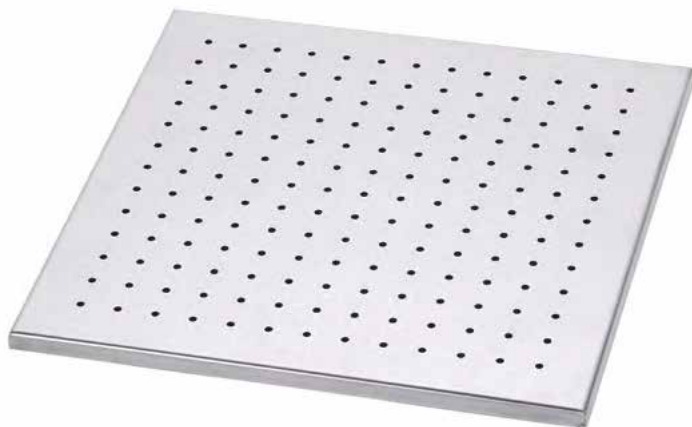

**P/68001**

Plancha inox para 169 brochetas (foam incluido)  
Display board for 169 skewers (foam included)  
30 x 30 x 1 cm

**P/68000**

Foam recambio para plancha inox P/68001  
Spare foam board for display P/68001  
29.9 x 29.9 x 1 cm





P/68002  
Soporte inox para 30 conos / Display for 30 cones  
Ø 2 cm  
50 x 15 x 8 cm



P/68009  
Soporte inox para 4 conos  
Display for 4 cones  
Ø 3 cm  
14 x 11 x 8 cm



P/68007  
Soporte inox para 1 cono  
Display for 1 cone  
Ø 3 cm  
7.5 x 6 x 8 cm



P/68008  
Soporte inox para 2 conos  
Display for 2 cones  
Ø 3 cm  
14 x 6 x 8 cm



## Malla Inox Stainless Steel Mesh

Malla en forma de tapete fabricado en acero inoxidable 18/10 alimentario, permite ser doblado y formado como un soporte a medida para cada plato. Infinitas formas y recursos para el emplatado de aperitivos, postres y degustaciones. Lavable en lavavajillas.

Mat-shaped mesh made of 18/10 food grade stainless steel. It can be folded and shaped as you wish, creating a custom holder for each dish. Create infinite shapes to serve appetizers, desserts and tastings. Dishwasher safe.



## Malla Inox Stainless Steel Mesh

P/50000 Fina / Fine

P/50001 Media / Medium

P/50002 Gruesa / Thick

25,5 x 17,5 cm



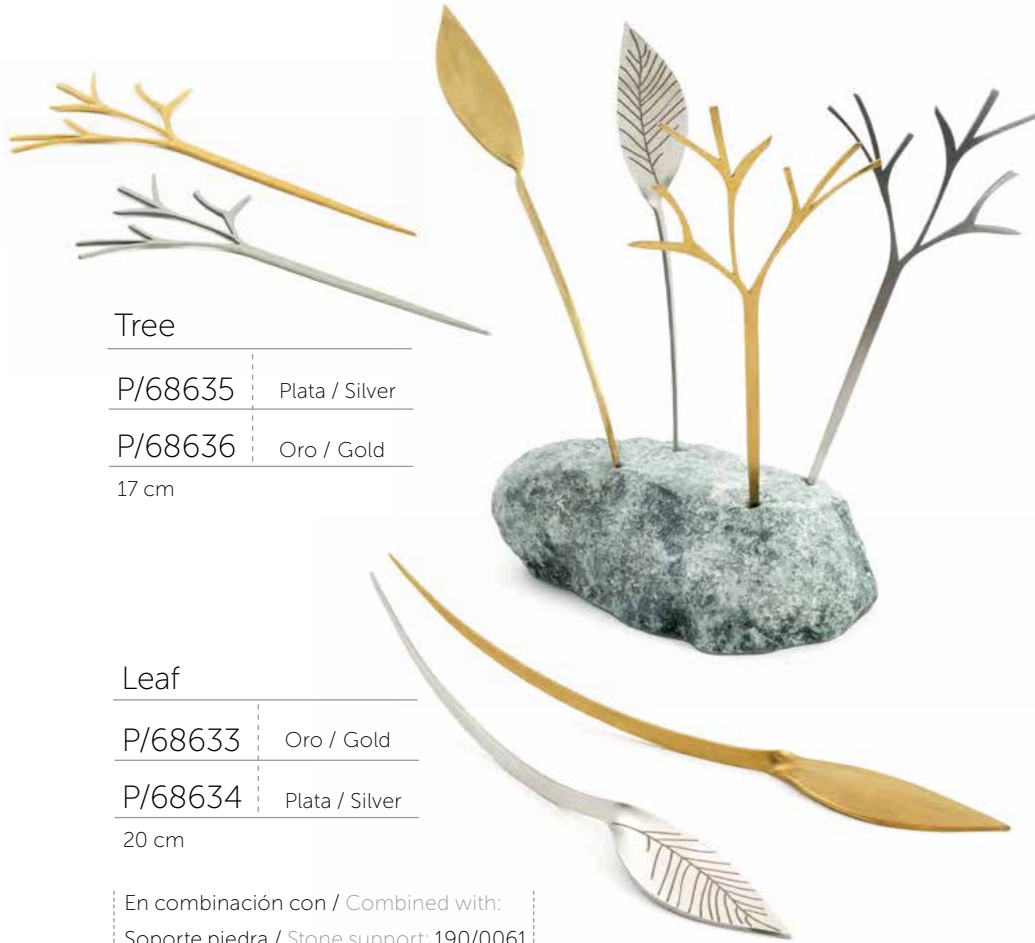

Tree

P/68635 Plata / Silver

P/68636 Oro / Gold

17 cm

Leaf

P/68633 Oro / Gold

P/68634 Plata / Silver

20 cm

En combinación con / Combined with:  
Soporte piedra / Stone support: 190/0061

C6980  
Cocktail Stick  
Stainless steel

10 cm

C1543  
Cocktail Stick  
Gold

C1559  
Cocktail Stick  
Copper

C8643  
Cocktail Stick  
Black

C6981  
Large Stick  
Stainless steel

13 cm

C1544  
Large Stick  
Gold

C1560  
Large Stick  
Copper

C8644  
Large Stick  
Black

P/64226  
Brocheta Fjord / Fjord skewer  
18 cm

P/64630  
9 cm

P/64629  
7 cm

P/64910  
Brocheta TEPPO / TEPPO skewer  
15 cm

P/64911  
10.5 cm

P/68631  
Brocheta Cubik / Cubik skewer  
10 cm

P/68632  
Brocheta Tube / Tube skewer  
10 cm

*"Ya sea en alta cocina, pastelería o coctelería, los moldes ofrecen alternativas modernas y originales para crear detalles con precisión y facilidad"*

*"Moulds offer modern and original alternatives for creating precise and intricate details in haute cuisine, confectionery and pastry"*



# MOLDES Y MARCADORES MOULDS & MARKERS

SILICONA / SILICONE .....	511
Moldes flexibles versátiles y prácticos Flexible, versatile and practical moulds	
PLANTILLAS / TEMPLATES .....	523
Plantillas para dar forma a productos espatulables Stencils for shaping spatulable products	
TERMOCONFORMADOS / THERMOFORMING .....	524
Moldes rígidos y resistentes de PET PET rigid and resistant moulds	
HIELO / ICE .....	528
Preparación de hielo transparente con diferentes formas Preparation of clear ice with different forms	
MARCADORES / MARKERS .....	533
Personalización en hielo y fuego, eléctricos o con relieve Customization in ice and fire, electric or embossing	

# SILICOMOLD

## TUILLES

Moldes inspirados en la naturaleza

Nature-inspired moulds

Gran variedad de originales moldes inspirados en animales y vegetales. Crea decoraciones comestibles para preparaciones dulces, saladas o incluso de coctelería.

A great variety of original moulds inspired by animals and vegetables. Create edible decorations for sweet and savory dishes, or even cocktails.

A	60/0022	Rodeo	Ø 5 cm
B	60/0023	Butterfly	6 x 5 cm
C	60/0024	Contorni	Ø 10 cm
D	60/0025	Honeycomb	5 x 12 cm
E	60/0026	Mix leaf	4 x 6 cm
F	60/0027	Feather	3,5 x 9 cm
G	60/0028	Arabic	3 x 12 cm
H	60/0029	Bubble	2,5 x 13 cm
I	60/0030	Ivy	2 x 9,5 cm
J	60/0031	Mandala	8,5 x 8 cm
K	60/0032	Sardine	2 x 10 cm
L	60/0033	Fossil	Ø 8 cm
M	60/0034	Fern	2,5 x 7 cm



A



B



C

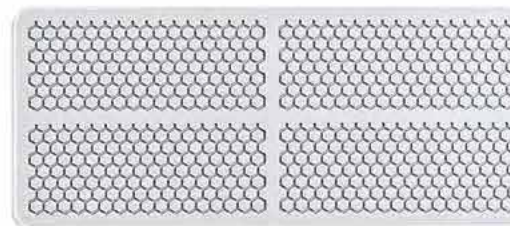

D



E





F

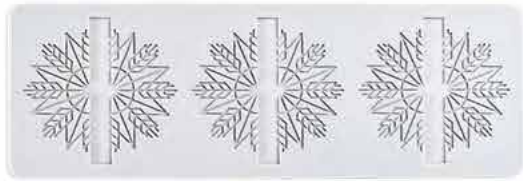

J



G



K



H



L



I



M





N



O



Q

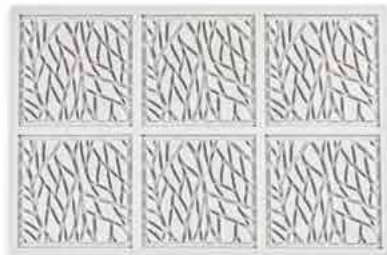

P



R

N	60/0035	Chili	3 x 7,5 cm
O	60/0036	Algae	Ø 7,5 cm
P	60/0037	Bamboo	6 x 6 cm
Q	60/0038	Fish	4 x 11,5 cm
R	60/0039	Bee	11 x 8,5 cm
S	60/0040	Coral	7,5 x 6 cm

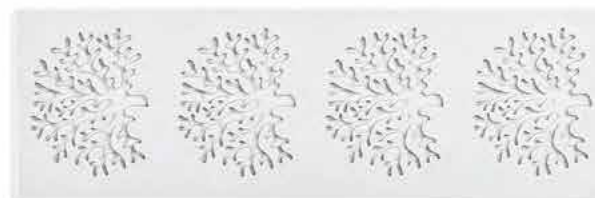

S

# SILICOMOLD FORMS

Moldes 3D geométricos  
Geometric 3D moulds

Conjunto de moldes con formas geométricas ideales para ser utilizados como base para postres o platos salados.

This set of moulds features geometric shapes and is ideal to use as a base for desserts or savoury dishes.

A	60/0041	Circle	Ø 4,5 x 1,5 cm
B	60/0042	Petal	Ø 4,5 x 2 cm
C	60/0043	Drop	2 x 4 x 2 cm
D	60/0044	Lollipop	Ø 3 cm
E	60/0045	Sphere S	Ø 2,5 cm
F	60/0046	Sphere M	Ø 4,5 cm
G	60/0047	Sphere L	Ø 5,5 cm
H	60/0056	Flower	6,5 x 6,5 x 1,5 cm
I	60/0058	Quenelle	3 x 6 x 2,5 cm
J	60/0059	Cube	2 x 2 x 1,5 cm



A



E



B



F



G



C



H



D



I

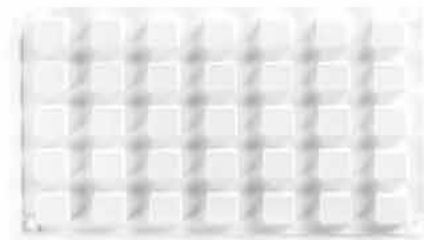

J



# SILICOMOLD

## MIMETIK

Moldes 3D para mimetizar  
3D molds for mimetizing

Moldes inspirados en frutas y otras formas originales  
diseñados en 3D para reproducir al detalle cada pieza.

Moulds inspired by fruits and other original shapes  
designed in 3D to reproduce each piece in detail.

A	60/0048	Chesnut	3 x 2,5 x 1,5 cm
B	60/0049	Tangerine	2 x 3,5 x 1,5 cm
C	60/0050	Peanut	1,5 x 4,5 x 1,5 cm
D	60/0052	Raspberry	2,5 x 3 x 2,5 cm
E	60/0053	Rock	2,5 x 3 x 1 cm
F	60/0054	Bone	4,5 x 4 x 2,5 cm
G	60/0055	Emmental	3 x 5 x 2 cm
H	60/0057	Edam	4,5 x 5,5 x 4 cm
I	60/0060	Lips	9,5 x 5 x 3,5 cm
J	60/0061	Lemon	4 x 5,5 x 2,5 cm
K	60/0062	Pepper	2,5 x 9 x 2 cm
L	60/0063	Blackberry	Ø 4 cm



A



D



B



E



C

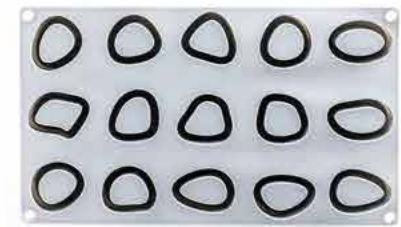

F





G



J



H



K



I



L



Rellena fácilmente tus moldes con nuestro *dosificador*  
Fill your moulds easily with our *dispenser*

# SILICOMOLD

## LOLLYMOLD

Moldes para helados  
Ice cream moulds

¡Dale forma a tus preparaciones frías y  
sorprende a tus clientes!

Shape your cold preparations and surprise  
your customers!

60/0064  
Skull

4,5 x 6,5 x 2 cm

60/0065  
Lingot

2 x 6,5 x 2 cm



60/0067  
Stripped Ice Cream

3,5 x 6,5 x 2 cm

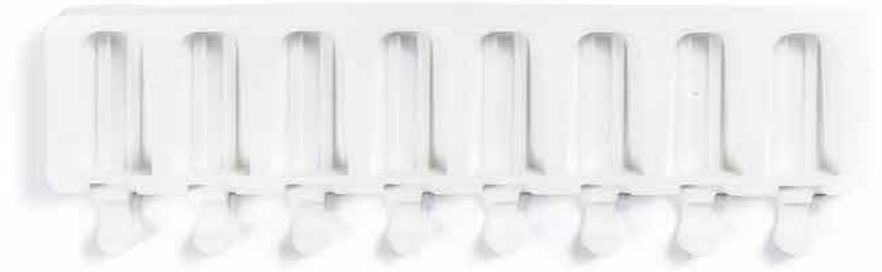

60/0066  
Ice Cream

3,5 x 6,5 x 2 cm



# Oh! Mold

Silicona líquida para moldes personalizados  
Liquid Silicone for custom moulds

La silicona líquida alimentaria Oh! Mold es una herramienta pensada para quienes quieren crear moldes totalmente personalizados con comodidad y precisión.

Su fórmula de dos componentes se mezcla de forma muy fluida, sin generar burbujas y sin necesidad de bomba de vacío, lo que agiliza el trabajo y evita pasos extra. Permite reproducir cualquier forma, textura o detalle, desde grabados finos hasta frutas, verduras o logos, con un acabado flexible y firme.

Oh! Mold is a liquid food-grade silicone is designed for those who want to easily and precisely create fully customised moulds.

Its two-component formula mixes smoothly without creating bubbles, eliminating the need for a vacuum pump and speeding up the process. It enables you to reproduce any shape, texture or detail, from fine engravings to fruit, vegetables or logos, and provides a flexible yet firm finish.



Técnicas de moldeado personalizado  
Custom moulding techniques

YouCook

A  
1Kg

+

B  
1Kg



EXTRA  
Soft - Blando  
20 SH

60/0068

OH! MOLD

Silicona líquida alimentaria  
Liquid foodgrade silicone

2 Kg



Instrucciones en  
User manual in  
EN - SP - FR - IT





Resistencia a ácidos, grasas, chocolate y alcoholes <20 Vol.  
Color translúcido.  
Estable y resistente, desde -25°C, hasta 220°C.  
Certificación alimentaria CE y FDA.  
Apto para horno, congelador, microondas y lavavajillas.  
Poros muy cerrados que reducen la contaminación.

Resistant to acids, fats, chocolate, and alcohols <20 Vol.  
Translucent colour.  
Stable and resistant from -25°C to 220°C.  
CE and FDA food certification.  
Suitable for use in the oven, freezer, microwave and dishwasher.  
Very small pores that reduce contamination.

Oh! Mold permite trabajar más rápido porque no necesita bomba de vacío, y su mezcla fluida simplifica todo el proceso incluso en piezas delicadas. Su resistencia a ácidos, grasas, chocolate y alcoholes, junto con un poro muy cerrado, garantiza durabilidad y menos riesgo de contaminación.

Oh! Mold enables you to work more quickly as it does not require a vacuum pump, and its fluid mixture streamlines the entire process, even with delicate pieces. Its resistance to acids, fats, chocolate and alcohol, together with its tightly closed pores, guarantees durability and reduces the risk of contamination.



Oh! Mold combina dos componentes líquidos A+B que reaccionan entre sí al mezclarse a partes iguales. La mezcla queda estable y libre de burbujas, así que solo hay que verterla sobre la pieza a reproducir y dejar que se seque y cure por completo. Una vez lista, se obtiene un molde sólido y flexible que puede reutilizarse todas las veces que sea necesario. Su dureza de 20 SH facilita el desmolde y aporta la precisión que requieren trabajos de pastelería, cocina y coctelería. Para un resultado aún más limpio, se recomienda aplicar el spray antiadherente durante la creación del molde.

Oh! Mold is a two-part liquid mixture (A+B) that reacts when mixed in equal quantities. The resulting mixture is stable and free of bubbles, so all you have to do is pour it over the piece to be reproduced, leaving it to dry and cure completely. Once ready, you will have a solid, flexible mould that can be reused as many times as necessary. With a hardness of 20 SH, it is easy to remove from the mould and provides the precision required for pastry, cooking and cocktail making. For an even cleaner result, we recommend applying non-stick spray when creating the mould.



60/0019  
Spray antiadherente para  
realizar moldes de silicona 80 ml  
Nonstick spray for  
silicone making





¡Consigue replicar formas y productos fácilmente siguiendo los pasos y consejos que mostramos en YouCook!

Follow the steps and tips we show you on YouCook to easily replicate shapes and products!



Aprende a hacer moldes paso a paso  
Learn how to make moulds step by step







# Krokanters





Plantillas para crear tejas y crujiertes  
Templates for creating tiles and crackers

Plantillas de polipropileno para trabajar con productos espatulables sobre Teflón o silicona.  
Elabore crujiertes, snacks, guarniciones y decoraciones deshidratadas saladas y dulces.

Polypropylene stencils for working with spatulable products on Teflon or silicone.

For making crunchy, sweet and savoury snacks, garnishes and dehydrated decorations.

<b>60/1001</b> Geometrik Kit 34 x 17 cm	 18 uds pcs	 16 uds pcs
	 18 uds pcs	 21 uds pcs
Pack 4 Plantillas diferentes Assorted stencils	4.2 x 4.2 cm	3 x 6 cm
	Ø 4.2 cm	4.5 x 4.5 cm

<b>60/1002</b> Naturaka Kit 34 x 17 cm	 8 uds pcs	 8 uds pcs
	 12 uds pcs	 12 uds pcs
Pack 4 Plantillas diferentes Assorted stencils	7.5 x 6.5 cm	7 x 6 cm
	9.8 x 2.8 cm	9.8 x 2.8 cm

\* Producto aprobado por expertos profesionales en cuanto a tamaño, grosor y redondeado de los ángulos.

\* Product approved by professional experts in terms of size, thickness and rounded corners.



# Chocolate Forms

Colección de moldes profesionales  
Professional mould collection

Moldes termoformados reusables para chocolate y *Petits Fours* creativos. De fácil desmolde y apto para uso alimentario.

Re-usable thermoformed moulds for chocolate and creative *Petits Fours*. Easy demoulding and food safe.

## Chocolate Forms

60/1201	Diamond
60/1203	Bubbles
60/1204	Bar

Tamaño de cada plantilla / Mould Sizes: 25 x 30 cm - 1 mm



Apto para congelación  
Frost resistant



Apto para lavavajillas  
Dishwasher safe



Max temp. 60°C



16 recetas con krokanters  
16 recipes with krokanters

100%Lab



Barcelona, capital del chocolate  
Barcelona, chocolate capital

100%Lab

DIAMON 5.3 ml



BUBBLES 69 ml



BAR 6.6 ml



# EASYMOULD

THE FIT MOULD COLLECTION

Easymould es el sistema más rápido y sencillo para moldear con láminas troqueladas de PET. Están listas para confeccionar piezas uniformes con un acabado perfecto, son de fácil desmoldaje, multifuncionales, y limpias.

Emplee Easymould en pastelería, catering o cocina. Prepare gelatina, mousses, tartars, helados, snacks, lollypops dulces o salados...

Easymould is the fastest and easiest system for molding with die-cut PET sheets. They are ready to make uniform pieces with a perfect finish, are easy to remove from the mold, multifunctional, and clean.

Use Easymould in pastry shops, catering, or cooking. Prepare gelatin, mousses, tartars, ice cream, snacks, sweet or savory lollipops...

Easymould  
REDONDO / ROUND **100** uds  
pcs

60/0004

S - 4 cm

60/0005

M - 6 cm

60/0006

L - 8 cm

Ø 2,5 cm



## Easymould Base

REDONDO / ROUND

60/0010

**3** uds  
pcs

60/0011

**24** uds  
pcs

ECONOMIC  
PACK

Para 35 piezas / For 35 pcs x 3





### Easymould Base

CUADRADO / SQUARE

60/0012

3 uds  
pcs

60/0013

24 uds  
pcs

ECONOMIC  
PACK

Para 35 piezas / For 35 pcs x 3



### Easymould

CUADRADO / SQUARE

100 uds  
pcs

60/0007

S - 4 cm

60/0008

M - 6 cm

60/0009

L - 8 cm

Base 2 x 2 cm

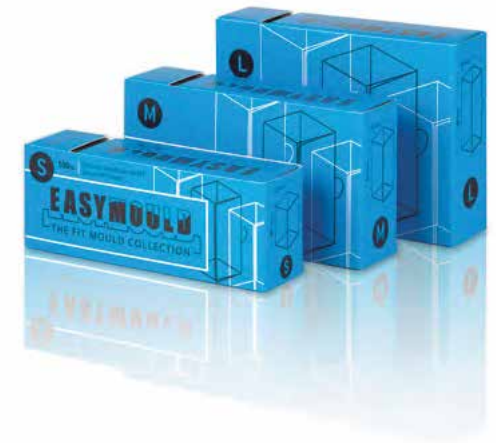

Cómo usar Easymould  
How to use Easymould

YouCook



## Lipstick Mould

60/0001  
Lipstick Mould 3D

Moldes fabricados en PET para formar piezas con mousses, purés de fruta, gelatinas o chocolate.

Moulds made in PET for moulding lipstick bars with fruit purees, jelly or chocolate.



Apto para congelación  
Frost resistant



Apto para lavavajillas  
Dishwasher safe

## Lipstick Tubes

100/0008  
Lipstick Tube transparente  
Clear Lipstick Tube

100 uds  
100 pcs



Consejos para Lipstick  
Lipstick tips

**YouCook**



## Lollipop Mould

60/0002  
Lollipop mould 3D

## Lollipop Stick

100/0124  
Lollipop palito púrpura  
Purple Lollipop Stick

1000 uds  
1000 pcs

10 cm



Guía para Lollipop  
Lollipop guide

**YouCook**



## IceBall Mould

Molde para esferas de hielo  
Spherical ice cube mould



60/0003  
Ice Ball Mould

Ø 6 cm

¡Fácil desmolde y gran producción!

Easy removal, perfect finish and fast production!



## Square IceCube Mould

Molde para cubitos de hielo  
Square ice cube mould

Crea las condiciones de congelación de lagos y ríos naturales, obteniendo cubitos de hielo transparente y descartando las impurezas en el fondo.

Es posible conseguir hasta tres formatos de hielo claro, brillante y transparente.

Square Ice Cube Mould imitates the natural process of lakes and rivers freezing, obtaining transparent ice cubes and discarding impurities at the bottom. You can obtain up to 3 different sizes of clear, shiny and transparent ice.

60/0017  
IceCube Mould



2 x 2 x 6 cm  
32 cubitos/cubes



4 x 4 x 4 cm  
8 cubitos/cubes



9 x 9 x 9 cm  
2 cubitos/cubes



Produce tu propio hielo cristalino  
Produce your own crystal-clear ice

alinia permite crear lotes de hielo transparente, brillante y sin burbujas en los formatos más usados en coctelería: esferas, diamantes, cubos XL y barras Collins. Todo con un proceso simple, automático y sin esfuerzo.

Solo eliges el molde, cierras la puerta y pulsas "ICE", y en tan solo 24 horas tendrás hielo cristalino de calidad profesional, listo para servir.

alinia is the machine that allows you to produce flawless, transparent, bubble-free ice in the most popular shapes for cocktail service: spheres, diamonds, large cubes, and Collins bars. The process is simple, fully automatic, and effortless.

Just select the mold, close the door, and press "ICE." In 24 hours, you'll have perfect crystal-clear ice ready to serve.

alinia

30/0123	A1	1 Bandeja	4 Kw	15 L	220 V
30/0124	A2	2 Bandejas	6 Kw	30 L	220 V
30/0139	A2	2 Bandejas	6 Kw	30 L	120 V

\* No incluye moldes, deben pedirse aparte

\* Moulds are not included, they must be ordered separately

### Calidad de hielo superior

Cristalino, sin burbujas



#### Premium Ice

Crystal-clear, bubble-free

### Ahorro rápido

Reduce costes un 95%  
Amortización en 6 - 12 meses



#### Quick Payback

Cuts costs by 95%  
ROI in 6-12 months

### Formatos personalizados

Crea tu propio deiseño de molde



#### Custom Shapes

Create your own exclusive design



### Eficiencia total

Bajo consumo de agua y energía



#### Total Efficiency

Low water and energy use

### Máxima duración

Hasta 5 horas sin derretirse



#### Long-lasting Performance

Up to 5 hours without melting



alinia clear ice service





## ¿Cómo trabaja alinia? How alinia works?

alinia, by The Space, revoluciona la producción de hielo gracias a su tecnología de congelación direccional, creando de manera eficiente hielo transparente con geometrías, sin necesidad de de cortar o tallar.

Según las pruebas realizadas por el LAB de 100% Chef, el hielo cristalino generado, conserva su forma durante al menos 5 horas, ya que la temperatura de su centro puede descender hasta  $-20^{\circ}\text{C}$ , asegurando una experiencia de enfriamiento óptima que permita disfrutar de las bebidas por más tiempo.

alinia, by The Space, revolutionizes ice production because of its directional freezing technology, efficiently creating geometric transparent ice without the need for cutting or shaping it.

According to tests conducted by 100% Chef's LAB, the crystalline ice generated retains its shape for at least 5 hours, as its core temperature can drop to  $-20^{\circ}\text{C}$ , ensuring an optimal cooling experience that allow enjoying the drinks for a longer time.

### Optimización:

Consejos para conseguir un mayor rendimiento, aunque alinia es totalmente compatible con equipos estándar de filtraje.

- Toma de agua y desagüe a 1 m
- Instalar un prefiltro de descalcificación y purificación
- Calidad del agua:
  - Agua filtrada con sistema de osmosis inversa realimentada con calcio y magnesio
  - Dureza PH9 55 ppm
  - Conductividad 43  $\mu\text{S}/\text{cm}$

### Optimization:

Tips to achieve a higher performance, even though Alinia is fully compatible with standard filtration equipment.

- Water source and drainage at 1 m
- Install a descaling and purification pre-filter
- Water quality:
  - Reverse osmosis filtered water with calcium and magnesium replenishment
  - Hardness PH9 55 ppm
  - Conductivity 43  $\mu\text{S}/\text{cm}$

**alinia**  
PREMIUM CLEAR ICE SERVICE



## Moldes para alinia alinia moulds

Fabricados con silicona Platinum de grado alimenticio y libres de BPA, estos resistentes moldes de alta calidad proporcionan un hielo totalmente transparente con acabado brillante.

- Cada juego incluye una bandeja de acero inoxidable AISI 316 para disponer los moldes de hielo en alinia.
- Los moldes se pueden combinar en una misma bandeja, exceptuando la ref. 30/0129 dado su volumen.

Made with food-grade Platinum silicone and BPA-free, these durable high-quality molds provide a glossy and completely transparent finish to the ice.

- Each set includes an AISI 316 stainless steel tray for placing the ice molds in alinia.
- The molds can be combined on the same tray, except for ref. 30/0129 due to its volume.

## Kit moldes alinia / alinia moulds kit

30/0125	● Esfera / Sphere	Ø 6 cm	Kit 25 moldes / moulds
30/0129	● Esfera / Sphere	Ø 7,5 cm	Kit 16 moldes / moulds
30/0126	■ Cubo / Cube	5,5 x 5,5 cm	Kit 30 moldes / moulds
30/0127	■ Collins	4 x 4 x 10 cm	Kit 24 moldes / moulds
30/0140	■ Collins	4 x 4 x 12 cm	Kit 18 moldes / moulds
30/0128	◆ Diamante / Diamond	6 x 5 cm	Kit 30 moldes / moulds



MOLDES PERSONALIZABLES - ¡CREA TU PROPIA FORMA!  
CUSTOMIZABLE MOULDS - CREATE YOUR OWN SHAPE!





## Rentabilidad

### Profitability

Para quienes priorizan la calidad del hielo premium y conocen el impacto de su consumo regular, alinia representa una alternativa inteligente y rentable.

Con un retorno de inversión rápido; menos de 12 meses para el modelo A1 y apenas 6 meses para el A2, el gasto de la producción de hielo cristalino se puede reducir hasta un 95% comparado con la compra convencional.

La rentabilidad de producción en un ciclo que dura 24 horas del modelo A1 es de 0,50 € / ciclo y de 0,75 € / ciclo del modelo A2. Es una inversión que pronto se verá nuevamente aprovechada.

For those who prioritize premium ice quality and understand the consequences of regular consumption, alinia represents a smart, cost-effective alternative.

With a fast return on investment of less than 12 months for the A1 model and just six months for the A2 model, the cost of producing crystal ice can be reduced by up to 95% compared to conventional purchasing.

The production return on a 24-hour cycle for the A1 model is 0.50 € / cycle and 0.75 € / cycle for the A2 model. It is an investment that you will soon see a return on investment.

### Coste unitario del hielo, utilizando alinia A2, con consumo de agua y electricidad:

Unit cost of ice, using Alinia A2, with water and electricity consumption:

● 0,06 €	■ 0,06 €
● 0,1 €	■ 0,06 €
■ 0,05 €	◆ 0,05 €

## YETI, ice marking tray

Marcador para hielo con tapete de silicona

Ice marker tray with silicone mat

Elaborada en aluminio anodizado, la bandeja YETI permite personalizar cubos de hielo con formas y diseños únicos. Su superficie cuenta con múltiples áreas de marcaje adaptadas a diferentes tamaños de hielo, y dispone de desagües en cada cuadrícula que permiten evacuar el agua derretida, evitando el sobreenfriamiento.

YETI incluye 3 diseños para hielo tipo Collins (13 x 4 cm útiles) y 4 diseños cuadrados combinables (5,5 x 5,5 cm útiles). Este modelo, en concreto, incorpora un tapete de goma que evita el derrame de agua sobre la mesa, asegurando un espacio limpio.

Made from anodized aluminum, the YETI tray allows you to personalize ice cubes with unique shapes and designs. Its surface features multiple marking areas adapted to different ice sizes, and each grid is equipped with drains to remove melted water, preventing overcooling.

YETI includes 3 Collins ice designs (13 x 4 cm usable) and 4 square designs that can be combined (5,5 x 5,5 usable cm). This model, in particular, incorporates a rubber mat that collects excess water, ensuring a clean environment during use.



800/0028

YETI tapete de silicona  
Silicone mat YETI



Descubre YETI  
Discover YETI

YouCook

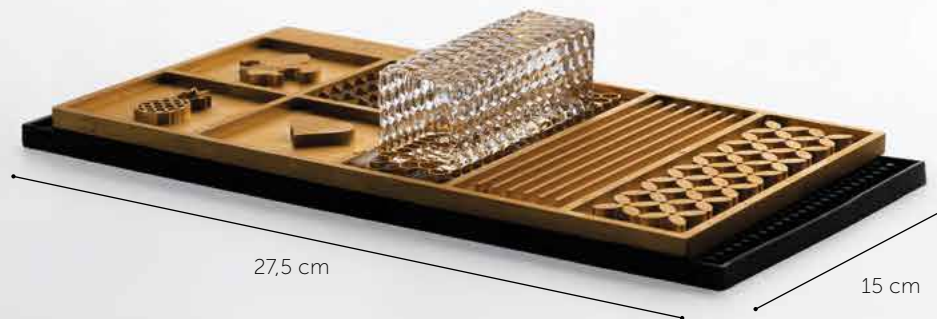

YETI con bandeja negra recoge aguas  
 YETI with black drip tray

Escoge la versión YETI con bandeja recoge aguas para evita el derrame del agua fundida sobre la barra, facilitando el atemperamiento de la bandeja de aluminio.  
 Choose the YETI version with water collection tray to avoid spillage of melted water on the bar, facilitating the tempering of the aluminum tray.

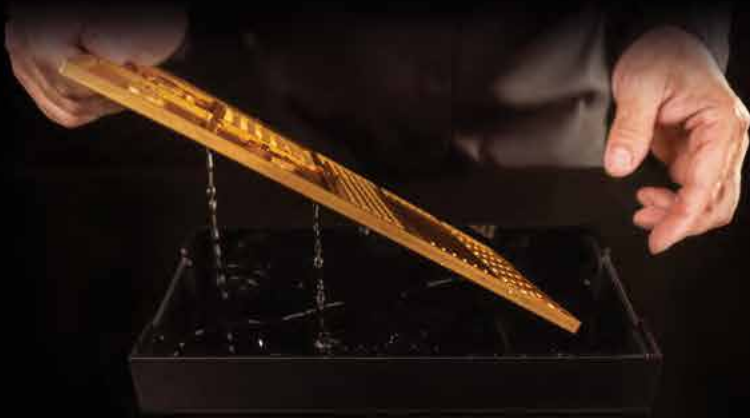

MARCADORES YETI PERSONALIZABLES  
 YETI CUSTOMIZABLE MARKERS

Personalización para bandejas Yeti  
 Customization for Yeti trays

Diseña tus propias personalizaciones eligiendo entre tamaños cuadrados o Collins, según tus necesidades.

Una vez lo tengas solo deberás colocarlo en el hueco de la bandeja que prefieras y el diseño se grabará con gran precisión en tus hielos.

Design your own customizations by choosing between square or Collins sizes, depending on your needs.

Once you have it, simply place it in the tray slot of your choice and the design will be engraved with great precision on your ice cubes.

800/0032  
 YETI bandeja recoge aguas  
 Black drip tray YETI





## Ice Ball Press

Prensa para producir esferas de hielo  
Press to produce ice balls

Prensa de aluminio macizo para producir esferas de hielo perfectas a partir de un bloque de hielo. Disponible en dos diferentes diámetros.

Solid aluminum press to produce perfect ice spheres from a block of ice. Available in two different diameters.

### Ice Ball Press

60/0020	Ø 8 cm
---------	--------

60/0021	Ø 6 cm
---------	--------



## Marcador de hielo para esferas

### Round ice marker

Diseñado para personalizar fácilmente esferas de hielo con el logo o motivo de tu elección, este elegante marcador acabado en cromo, graba a presión sobre el hielo dejando una impresión duradera sin esfuerzo.

Designed to easily customize ice spheres with the logo or motif of your choice, this sleek chrome-finished marker presses into the ice, leaving an effortless, lasting impression.

## Marcador de hielo para esferas

### Round ice marker

800/0029	Ø 6 cm
800/0030	Ø 7,5 cm



Personalización de hielos  
Ice customization

**YouCook**

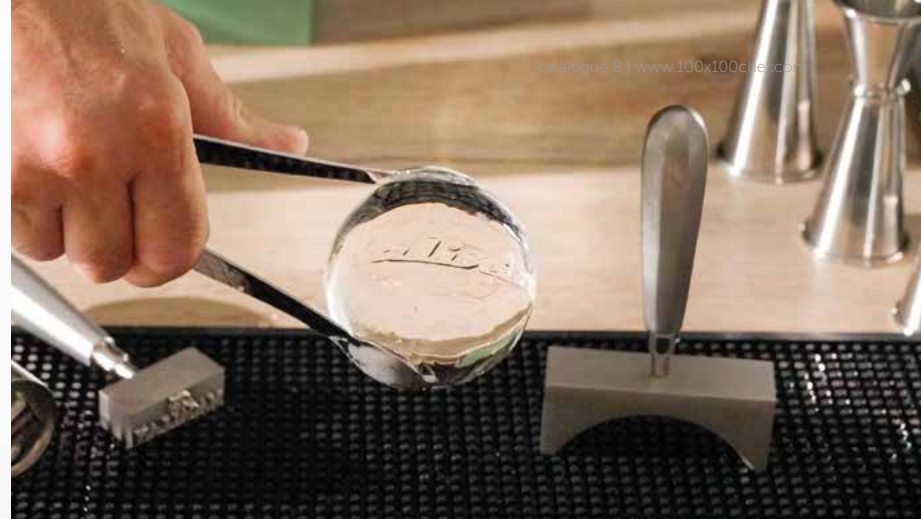

## Marcador de hielo personalizado

Dale un sello distintivo a tus servicios con este marcador a presión, ideal para imprimir tu logo o diseño personalizado sobre cubitos de hielo.

Rediseñado con un mango metálico resistente y un acabado cromado elegante, ofrece un manejo cómodo y una presión precisa. Su estructura robusta permite marcar varios cubitos al mismo tiempo.

## Marcador de hielo Ice marker

800/0022	3 x 3 cm
800/0023	4 x 4 cm
800/0024	5 x 5 cm
800/0026	Ø 3 cm
800/0027	Ø 4 cm

Más medidas disponibles bajo demanda  
More options available on request

## Custom ice marker

Give a distinctive touch to your services with this pressure marker, ideal for imprinting your logo or custom design on ice cubes.

Redesigned with a solid metal handle and a sleek chrome finish, it offers comfortable handling and precise pressure. Its sturdy structure allows you to mark several ice cubes at the same time.





## ¡Personaliza! Customize!

Marcadores de latón, grabado con su logo o motivo. Marque y personalice alimentos, panes, carnes, pieles, frutas, soportes de madera como cajas, mini pallets de madera, palos de polos y todo lo que su fantasía sugiera. Resistente al fuego directo y al soplete.

Brass custom branding irons, engraved with your logo or design. Mark and personalize food, bread, meat, fish skin, fruit peels. Try them with wooden supports such as boxes, mini wooden pallets, ice cream sticks and anything your fantasy suggests. Resistant to direct fire and blowtorch.



## Marcador fuego Fire marker

800/0008	3 x 3 cm
800/0009	4 x 4 cm
800/0010	5 x 5 cm
800/0011	6 x 6 cm
800/0012	7 x 5 cm
800/0013	8 x 5 cm
800/0014	Ø 4 cm
800/0015	Ø 6 cm

## Marcador eléctrico burger Electric burger marker

800/0001	3 x 3 cm
800/0002	4 x 4 cm
800/0003	5 x 5 cm
800/0004	6 x 6 cm
800/0005	7 x 5 cm
800/0006	8 x 5 cm
800/0007	Hasta / till Ø 6 cm

Consulte para más medidas  
Ask for other sizes

Personalice todo tipo de panes como el pan de hamburguesa, tortillas de maíz, pan de pita, panes rústicos, además de otros productos resistentes al calor como carnes o cajas de madera para presentaciones.

Funciona a 220 y 110 V, 600 W.

Customize all kinds of breads such as burger buns, corn tortillas, pita bread, rustic breads, as well as other heat-resistant products such as meat or wooden boxes.

It operates at 220 and 110 V, 600 W.



## Diseñe su sello de silicona Design your own silicone seal

Cree su propio sello de silicona alimentaria con su diseño o logo. Estampe cualquier puré o tinta alimentaria. Pinte con cacao, mantequilla, grasa y espolvoree cualquier polvo como oro, plata o productos liofilizados.

Tampon carved in food silicone with your own design or logo. Print with any puree or food ink. Paint with cocoa, butter, fat and sprinkle any powder like gold, silver or freeze dried powders.

## Tampón de silicona personalizado Customized silicone seal

100/0181	4 x 3 cm
100/0182	6 x 4 cm

Consulte para otras medidas  
Consult for other sizes



## Grabador eléctrico Branding clamp

Grabador diseñado para colocar palitos de polo de diversas formas y medidas, además de brochetas o pinzas. Todos los marcajes quedan en la misma posición. Su temperatura es regulable y permite marcar madera, bambú, cuero y otros materiales.

Electric fire marker. Its base is designed to place ice-cream sticks of various sizes, skewers or tongs. All the marks are in the same position. Adjustable in temperature, it allows to mark wood, bamboo, leather and other materials.

100/0180  
Grabador personalizado eléctrico  
Custom branding clamp

230 V

Max. 40 x 9 mm





## Mini print

Grabador en relieve por presión.  
Cada caja contiene entre 2 y 3 unidades de la misma letra, incluye números y signos.

Pressure relief engraver. Each box contains 2-3 pcs of the same letter, including numbers and signs.

100/0040  
Mini print



## Logo Relief

Grabe su logo en etiquetas, tapas de yogurt, cartas de menú, invitaciones, posavasos, papeles metálicos como aluminio, hojas de oro, cartón, papel...

Engrave your logo on labels, yogurt lids, menus, invitations, coasters, metallic papers such as aluminium, gold leaves, cardboard, paper...

100/0056  
Logo Relief

Disponible en 3 formatos  
Available in 3 sizes:

Ø 3.8 cm  
Ø 4.8 cm  
4.8 x 2.3 cm

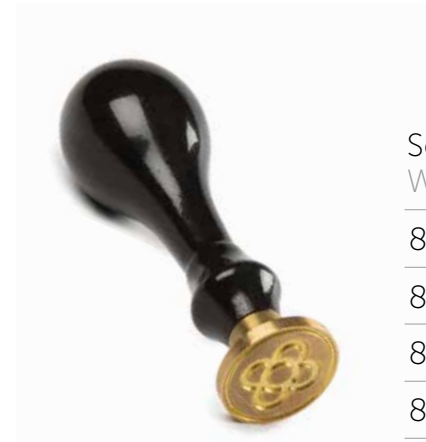

## Sello lacre Wax seal

800/0018	Ø 2 cm
800/0019	Ø 2,5 cm
800/0020	Ø 3 cm
800/0021	Ø 4 cm

Sellos personalizados para marcar a presión logos o pequeños motivos sobre chocolate, fondant, caramelo, gelatinas, mantequillas o deshidratados.

Engrave your logo on labels, yogurt lids, menus, invitations, coasters, metallic papers such as aluminium, gold leaves, cardboard, paper...



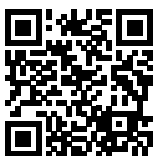

Déjese inspirar por  
Get inspired by **YouCook**

YouCook es el canal de vídeo de 100%Chef, dedicado específicamente a profesionales y apasionados de la cocina creativa.

Nuevas tendencias, técnicas y secretos además de todos los consejos de uso sobre los productos desarrollados por 100%Chef.

YouCook is the video channel by 100%Chef, specifically addressed to food and beverage professionals and to vanguard cuisine lovers.

New trends, techniques and secrets revealed, in addition to all the tips and tricks to get the most out of our products.

**100%Chef**

[www.100x100chef.com](http://www.100x100chef.com)

**100%Barman**

[www.100x100barman.com](http://www.100x100barman.com)

**100%Lab**

[www.100x100lab.com](http://www.100x100lab.com)

Find us / Share your creations:

 [orders@100x100chef.com](mailto:orders@100x100chef.com)

 [100x100chef.com](https://www.instagram.com/100x100chef.com)

Cocina sin Límites, S.L.

Joan Peiró i Belis, 2 - Pol. Ind. Vallmorena  
08339 Vilassar de Dalt - Barcelona, Spain  
+ 34 93 429 63 40

